



Includes: Notice 1 dated May 1996

**Goddard Space Flight Center
Preferred Parts List
PPL-21**

MARCH 1995

Prepared by:
The Parts Branch
Office of Flight Assurance
Goddard Space Flight Center

**Goddard Space Flight Center
Preferred Parts List .
PPL-21**

FOR INTERNAL USE ONLY

Approved by:

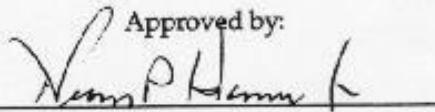

George P. Kramer, Jr.
Head, Parts Branch

Information Contained Herein Shall Not Be Used for Advertising or Publicity Purposes.

15-111
2001 02/24/01

GSFC Preferred Parts List

TO ALL HOLDERS OF GSFC PPL-21

1. THE FOLLOWING PAGES OF PPL-21 HAVE BEEN REVISED AND SUPERSEDE THE PAGES LISTED:

NEW PAGE	DATE	SUPERSEDED PAGE	DATE
iv-a	May 1996	NEW PAGE	
iv-b	May 1996	NEW PAGE	
01-1	March 1995	01-1	REPRINTED WITHOUT CHANGE
01-2	May 1996	01-2	March 1995
01-5	March 1995	01-5	REPRINTED WITHOUT CHANGE
01-6	May 1996	01-6	March 1995
01-9	May 1996	01-9	March 1995
01-10	March 1995	01-10	REPRINTED WITHOUT CHANGE
01-11	May 1996	01-11	March 1995
01-12	March 1995	01-12	REPRINTED WITHOUT CHANGE
01-13	May 1996	01-13	March 1995
01-14	March 1995	01-14	REPRINTED WITHOUT CHANGE
02-7	May 1996	02-7	March 1995
02-8	March 1995	02-8	REPRINTED WITHOUT CHANGE
02-13	May 1996	02-13	March 1995
02-14	March 1995	02-14	REPRINTED WITHOUT CHANGE
02-19	March 1995	02-19	REPRINTED WITHOUT CHANGE
02-20	May 1996	02-20	March 1995
02-21	May 1996	02-21	March 1995
02-22	May 1996	02-22	March 1995
02-23	March 1995	02-23	REPRINTED WITHOUT CHANGE
02-24	May 1996	02-24	March 1995
02-25	May 1996	02-25	March 1995
02-26	March 1995	02-26	REPRINTED WITHOUT CHANGE
02-35	May 1996	02-35	March 1995
02-36	March 1995	02-36	REPRINTED WITHOUT CHANGE
05-1	March 1995	05-1	REPRINTED WITHOUT CHANGE
05-2	May 1996	05-2	March 1995
06-1	May 1996	06-1	March 1995
06-2	March 1995	06-2	REPRINTED WITHOUT CHANGE
07-1	May 1996	07-1	March 1995

NEW PAGE	DATE	SUPERSEDED PAGE	DATE
07-2	May 1996	07-2	March 1995
07-3	May 1996	07-3	March 1995
07-4	March 1995	07-4	REPRINTED WITHOUT CHANGE
07-13	May 1996	07-13	March 1995
07-14	May 1996	07-14	March 1995
07-15	May 1996	07-15	March 1995
07-16	May 1996	07-16	March 1995
07-17	May 1996	07-17	March 1995
07-18	May 1996	07-18	March 1995
07-19	March 1995	07-19	REPRINTED WITHOUT CHANGE
07-20	May 1996	07-20	March 1995
08-9	March 1995	08-9	REPRINTED WITHOUT CHANGE
08-10	May 1996	08-10	March 1995
09-7	May 1996	09-7	March 1995
09-8	March 1995	09-8	REPRINTED WITHOUT CHANGE
09-9	May 1996	09-9	March 1995
09-10	May 1996	09-10	March 1995
09-11	May 1996	09-11	March 1995
09-12	March 1995	09-12	REPRINTED WITHOUT CHANGE
14-1	May 1996	14-1	March 1995
14-2	March 1995	14-2	REPRINTED WITHOUT CHANGE
14-3	May 1996	14-3	March 1995
14-4	March 1995	14-4	REPRINTED WITHOUT CHANGE
16-1	May 1996	16-1	March 1995
16-2	May 1996	16-2	March 1995
16-3	May 1996	16-3	March 1995
16-4	May 1996	16-4	March 1995
16-7	May 1996	16-7	March 1995
16-8	May 1996	16-8	March 1995
16-9	May 1996	16-9	March 1995
16-10	May 1996	16-10	March 1995
16-11	May 1996	16-11	March 1995
16-12	March 1995	16-12	REPRINTED WITHOUT CHANGE
16-13	March 1995	16-13	REPRINTED WITHOUT CHANGE
16-14	May 1996	16-14	March 1995
16-15	May 1996	16-15	March 1995
16-16	March 1995	16-16	REPRINTED WITHOUT CHANGE
A-1	March 1995	A-1	REPRINTED WITHOUT CHANGE
A-2	May 1996	A-2	March 1995
A-5	May 1996	A-5	March 1995
A-6	May 1996	A-6	March 1995
A-7	March 1995	A-7	REPRINTED WITHOUT CHANGE

NEW PAGE	DATE	SUPERSEDED PAGE	DATE
A-8	May 1996	A-8	March 1995
B-1	March 1995	B-1	REPRINTED WITHOUT CHANGE
B-2	May 1996	B-2	March 1995
C-9	March 1995	C-9	REPRINTED WITHOUT CHANGE
C-10	May 1996	C-10	March 1995
C-13	March 1995	C-13	REPRINTED WITHOUT CHANGE
C-14	May 1996	C-14	March 1995
C-31	March 1995	C-31	REPRINTED WITHOUT CHANGE
C-32	May 1996	C-32	March 1995
C-33	May 1996	C-33	March 1995
C-34	May 1996	C-34	March 1995
C-35	May 1996	C-35	March 1995
C-36	March 1995	C-36	REPRINTED WITHOUT CHANGE
C-43	May 1996	C-43	March 1995
C-44	May 1996	C-44	March 1995
C-45	March 1995	C-45	REPRINTED WITHOUT CHANGE
C-46	May 1996	C-46	March 1995
C-47	March 1995	C-47	REPRINTED WITHOUT CHANGE
C-48	May 1996	C-48	March 1995
E-1	May 1996	E-1	March 1995
E-2	May 1996	E-2	March 1995
E-3	May 1996	E-3	March 1995
E-4	May 1996	E-4	March 1995

2. RETAIN THIS NOTICE AND INSERT BEFORE TABLE OF CONTENTS.

3. Holders of PPL-21 will verify that page changes and additions indicated above have been entered. These notice pages will be retained as a check sheet. This issuance, together with appended pages, is a separate publication. Each notice shall be retained by the Office of Flight Assurance Information Center until the PPL is completely revised.

Custodian:

Parts Branch CPL Administrator
Code 311.2
Goddard Space Flight Center
Greenbelt, MD

To: Holders of GSFC Preferred Parts List

From: George Kramer, Jr.
Head, Parts Branch
Office of Flight Assurance

Subject: Issuance of GSFC Preferred Parts List No. 21

The Goddard Space Flight Center *Preferred Parts List*, PPL-21, supersedes PPL-20, Revision 1. This latest edition of the PPL is a departure from previous issues in that it combines and updates information from MIL-STD-975 (*NASA Standard Electrical, Electronic, and Electromechanical {EEE} Parts List*) and PPL-20 to create a “stand alone” document. It also incorporates the screening requirements from GSFC Parts Branch Instruction 311-INST-001 (*Instructions for EEE Parts Selection, Screening, and Qualification*) to provide detailed Grade 1 and Grade 2 screening requirements for all part categories. This endeavor has more than doubled the page count of the PPL, but the user no longer needs to consult MIL-STD-975 to obtain GSFC parts information. Military specifications and QPLs still must be consulted for some specific military part numbers and part availability.

Most part sections and appendices in PPL-21 have been changed. Users familiar with PPL-20 and MIL-STD-975 should have no problems navigating the new pages. Some of the more significant changes in PPL-21 include the following:

1. Section 01 (Capacitors)

- Preferred capacitors now include all capacitance values within the limits allowed for each type.
- Style CKS07 ceramic capacitors per MIL-C-123/3 are now listed as preferred parts in capacitance values up to and including 1 microfarad.
- The series resistance requirement note for MIL-C-39003 solid tantalum capacitors was expanded and clarified.
- The maximum value for style CKR06 ceramic capacitors per MIL-C-39014/2 was increased to 470,000 picofarads.
- Style CWR09 tantalum chip capacitors per MIL-C-55365 are now listed as preferred parts.
- The following multi-layer chip capacitors per MIL-C-55681 have been added to the PPL in order to increase the available capacitance range: styles CDR31, CDR32, CDR33, CDR34, and CDR35

2. Section 02 (Connectors)

- The section has been expanded from nine to forty pages and lists all preferred connectors. Some military specified connectors are no longer considered preferred.

- Insert arrangements, shell sizes, backshell information, materials, finishes, contact termination, and mounting hardware options, as applicable, are presented in tabular format.
 - Mil-C-38999 connectors have been upgraded to Grade 1 status, and Series IV connectors have been added.
 - Mil-C-24308 and GSFC 311 D-Subminiature connector characteristics and properties have been combined and presented in tabular format for easy comparison. Part numbers have been included for connectors without contacts, with float mount bushings, and with combination inserts for high voltage and coaxial contacts.
 - Mil-C-39012 series N and TNC connectors are no longer listed due to atomic oxygen erosion of the silver plating.
 - Mil-C-39012 SMA connectors for semi-rigid cable and MIL-C-83517 SMA transmission line connectors have been added.
 - Mil-C-55302/138, /139, and /190 through /193 printed circuit board connectors and Mil-C-83513 printed circuit board connectors have been added.
 - Connectors which are suitable only as Ground Support Equipment are no longer listed as preferred parts.
3. Section 06 (Relays)
- The GSFC preferred TO5 relays (S-311-P-754/01, 02, 05) have been reinstated because the manufacturer successfully completed requalification.
4. Section 07 (Resistors)
- The 0.001" minimum wire size requirement has been specified for all wirewound resistors. This limits the maximum resistance value available as a preferred part.
 - S-311-P-742 low TC, precision resistors are a new listing for Grade 1 and Grade 2 applications. One of the styles is a suitable alternative to the RNC90 per MIL-R-55182.
 - RNN style film resistors per MIL-R-55182 are now listed for Grade 1 and Grade 2 applications.
 - Style RM1010 chip resistors per MIL-R-55342/10 have been added.
5. Section 08 (Diodes) and Section 09 (Transistors)
- These sections have been completely reformatted and expanded to add additional parts and information, and eliminate references to Mil-STD-975. The diode section has increased from eight to twenty two pages and the transistor section from five to thirteen pages.
 - Parts are catalogued by device function and listed by their most critical parameters.
 - Numerous parts have been added or deleted in accordance with the latest QPL-19500 available at the time of publication.

- PIND testing has been added as a requirement for all JANTXV parts, which are now considered preferred Grade 2 parts with no additional screening.
6. Section 10 (Microcircuits)
 - This section has been completely reformatted to catalog all microcircuits by process technologies and device functions.
 - A hybrid microcircuit section has been added and lists parts from QML-38534.
 - All M38510 Class S and SMD Class V microcircuits are now considered preferred Grade 1 parts. All M38510 Class B and SMD Class Q microcircuits, with the addition of PIND testing, are now considered preferred Grade 2 parts.
 7. Section 14 (Thermistors)
 - The S-311-P-18 preferred thermistors are now available in Type A construction (ETFE insulated lead wires).
 - Type RTH42 thermistors per MIL-T-23648 have been upgraded to preferred status for Grade 1 applications.
 8. Section 16 (Wire/Cable)
 - The advantages/disadvantages of insulating materials has been incorporated into a new insulation selection guidelines table.
 - This section has been reformatted to allow wire comparison for combinations of insulating materials, voltage ratings, conductor alloys, and platings.
 - Mil-C-17 type RG-402 and RG-405 semi-rigid coaxial cables have been added. Type RG-179 flexible coaxial cable has been removed since crimp type connectors required to accommodate this cable are unavailable.
 - The Mil-C-27500 multiconductor cable part number explanation has been expanded to include codes for preferred base wire, shield, and jacket materials.
 9. Section 17 (Crystal Oscillators)
 - Type 1 crystal oscillators per MIL-O-55310 are new to the PPL. This first time listing includes the /08, /14, and /16 types.
 10. Section 51 (Optoelectronics)
 - Optoelectronics has been changed to an information/guidelines section since these parts do not fully satisfy preferred parts criteria. The section has been updated to reflect recent GSFC test and usage experience.
 11. Appendix A
 - The “Rescreening for JANTX/TXV Discrete Semiconductors” requirement of PPL-20 has been eliminated. PPL-21 requires only that JANTXV parts be PIND tested for Grade 2 applications.
 - This appendix consolidates the preferred parts additional testing requirements which were previously referenced in PPL-20 footnotes or Appendix B to MIL-STD-975. These

requirements are now in tabular format and cover certain select capacitors, connectors, fuses, resistors, diodes, transistors, microcircuits, and crystal oscillators.

12. Appendix B

- The derating requirements of PPL-20 and MIL-STD-975 have been reconciled and combined into simplified tables indexed by part type.
- The effective series resistance requirement for solid tantalum capacitors has been relaxed based on GSFC flight experience.
- Connector temperature derating requirements have been relaxed as a result of thermal vacuum testing and temperature modeling analysis.
- The derating factors for fuses rated 1/8 to 3/4 amperes have been tightened based on recent evaluations.
- Derating criteria for relays has been clarified with the addition of transient surge current limits.
- The resistor derating criteria includes a formula to enable the user to easily calculate the derated zero power temperature for any resistor type based on its power rating temperatures.

13. Appendix C

- All of the screening tables have been expanded and reformatted to provide more detailed requirements with minimum reference to other specifications. New screening tables have been added for hybrid microcircuits, transformers, wire & cable, crystal oscillators, and optoelectronics. Each table specifies screening requirements for both Grade 1 and Grade 2 parts that are consistent with GSFC Parts Branch Document 311-INST-001, *Instructions for EEE Parts Selection, Screening, and Qualification* (February 1995).

14. Appendix D

- The sections on Single Event Effects (SEE), selection of radiation-hard devices, and accessing the radiation data banks have been updated.
- Tables I and II, which list the Total Dose Radiation Testing for Goddard Projects and SEE Effects Testing, have been updated to include test reports through February 1995.

15. Appendix E

- This appendix was updated to reflect changes to the list of GSFC procurement specifications that should be used whenever preferred parts cannot be procured for Goddard applications.

To: Holders of GSFC Preferred Parts List
From: G. P. Kramer, Jr.
Parts Branch
Office of Flight Assurance

Subject: Issuance of Notice 1 to Preferred Parts List No. 21

Notice 1, dated May 1996, to the Goddard Space Flight Center *Preferred Parts List*, PPL-21, dated March 1995, supersedes PPL-21. The applicable Notice 1 pages replace existing PPL-21 pages which should be discarded.

The more significant changes contained in Notice 1 are as follows:

Section 01 - Capacitors

- The maximum value for style CKR06 ceramic capacitors per MIL-C-39014/2 has been increased to 470,000 picofarads.
- The 250 microJoule limit for metallized plastic film capacitors (MIL-C-83421) has been replaced with guidelines to ensure adequate clearing of these parts in various types of circuits.

Section 02 - Connectors

- Style MS3456 circular connectors per MIL-C-5015 have been added to the preferred parts list.

Section 07 - Resistors

- Standard values for the GSFC S-311-P-672 high voltage resistors have been eliminated.
- The hollow core restriction for MIL-R-55182 resistors has been removed.
- Style RM1005 chip resistors per MIL-R-55342/3 have been added to the list of preferred parts. This section has also been expanded to include parts with lower temperature characteristics (± 25 and ± 50 ppm/ $^{\circ}$ C).

Section 14 - Thermistors

- This section was updated to document the unusual practice of changing the document number of a very active military specification. MIL-T-23648 for style RTH thermistors was changed to MIL-R-23648 on 4 April 1995.

Section 16 - Wire and Cable

- The preferred parts list for MIL-W-22759 stranded wire has been expanded to include detail specifications /20, /41/, /43, /44 and /45.
- There have been numerous changes made to the application guidelines in this section.

Appendix B - Parts Derating Requirements

- The previous derating guidelines for fuses rated 3/4 amp and below have been restored.

Appendix C - Screening Requirements

- The connector contact resistance test requirements have been significantly changed.
- The static and dynamic burn-in requirements for certain types of monolithic IC's have been improved and clarified.
- Crystal oscillator screening requirements have been clarified to be consistent with MIL-STD-975 and the requirements of Appendix A.

PREFACE

PURPOSE

This document contains a list of preferred parts, additional test requirements for preferred parts, part derating guidelines, screening requirements for nonpreferred parts, details of space radiation effects, and a list of nonpreferred parts that can be procured to GSFC specifications. This document, together with GSFC Parts Branch Document 311-INST-001, *Instructions for EEE Parts Selection, Screening, and Qualification* (February 1995), should be used in the selection, procurement, and application of electrical, electronic and electromechanical (EEE) parts for GSFC space systems.

AUTHORITY

The *GSFC Preferred Parts List* (PPL) is authorized and invoked by Goddard Management Instruction (GMI) 5330.6, *Implementation of the Goddard Space Flight Center Parts Program*.

STANDARDIZATION

The GSFC PPL is the primary reference document for selecting, screening, and applying preferred EEE parts. Parts listed herein are preferred for GSFC flight applications and are considered standard parts for a particular project when specifically required by the Statement of Work or Performance Assurance Requirements (PAR) for that project. When preferred parts are designated as standard for a project, then the use of nonpreferred parts requires approval by the project office.

QUALITY LEVELS

PPL-21 specifies two part quality levels. Grade 1 parts are higher quality, government-specification-controlled parts intended for critical applications requiring the highest reliability. Grade 2 parts are high quality, government-specification-controlled parts which can be used in less demanding applications where mission reliability goals are less stringent. Grade 2 parts are not acceptable for Grade 1 applications unless approved by the cognizant project office.

PREFERRED PART PROCUREMENT

Parts listed in this document meet the requirements of either a military or NASA procurement specification. When a PPL-listed part is purchased, the procurement (purchase) order shall reference both the specification cited for the part and one or more of the recommended manufacturers listed in the corresponding Qualified Products List (QPL) for military specification parts or the GSFC Qualified Parts List Directory (QPLD) for NASA specification parts. Parts procured under other than the cited specifications or from an unlisted manufacturer, even if produced on the same production lines, are *nonpreferred* parts.

REFERENCED SPECIFICATIONS

Unless otherwise noted, all specifications referenced in the PPL are those which are in effect (by their issue or revision level) on the date the PPL or its notices are issued. Users are advised to refer to the latest revision of a cited specification and to its corresponding QPL or QPLD for any changes which might affect *preferred* part selections.

NONPREFERRED PARTS USAGE

GSFC discourages using *nonpreferred* parts. It is recognized, nonetheless, that certain applications may require parts which do not meet the requirements for being listed in the PPL. When this occurs, the Parts Branch recommends using Appendix E to select *nonpreferred* parts in preference to selecting commercial parts procured by non-government-controlled source control drawings. Appendix E parts are *nonpreferred* parts fully compliant to GSFC procurement specifications. The use of these parts may be approved more readily since GSFC has prior experience with Appendix E parts.

PARTS SCREENING

The screening tests in Appendices A and C are intended to eliminate quality defects that will prevent parts from meeting their performance requirements. However, screening is not a substitute for reliable design and process controls. Appendix C requirements should be imposed when a *nonpreferred* part must be procured, unless the part is procured to a GSFC-controlled specification.

USER RESPONSIBILITY

PPL-21 is intended for use in space flight programs. The user (contractor), product assurance engineer, and flight assurance manager are responsible for ensuring the proper grade level of parts are selected from the PPL consistent with the requirements of the applicable GSFC PAR.

PART CHARACTERISTICS

Electrical parameters and other characteristics are specified at 25° Centigrade (ambient), unless otherwise noted.

PART DERATING

Conservative application stresses are an important design tool for decreasing part degradation, prolonging their useful life and improving their failure rate. Recommended part derating factors are tabulated in Appendix B.

PART RADIATION EFFECTS

The space radiation environment can affect electronic part performance. Appendix D provides an overview of space radiation effects on EEE parts and lists radiation tests performed at GSFC. These test reports are available to qualified requesters.

CRITERIA FOR LISTING PARTS

Parts are listed in the PPL based on the following criteria:

- (1) Parts can be procured to NASA or military high reliability specifications;
- (2) Parts are qualified fully to their applicable specifications;
- (3) Parts are regularly produced devices and are available, preferably, from multiple sources;

- (4) Parts have sufficient technical maturity to assure that critical design and process parameters have been identified and controlled;
- (5) Parts have demonstrated a quality and reliability history consistent with GSFC program requirements;
- (6) Parts show potential for use on several GSFC projects;
- (7) Parts can meet special GSFC requirements, such as radiation tolerance, outgassing, environmental stresses, etc., as applicable.

CANDIDATE PARTS

Parts for which a potential use exists and which meet the criteria listed above ("Criteria for Listing Parts") may be brought to the attention of the Parts Branch. These candidate parts will be considered for future listing in the GSFC PPL. NASA or contractor users may direct their suggestions to the Parts Branch either in writing or by telephone at (301) 286-6631.

DOCUMENTS

Specifications cited in the PPL (both GSFC-controlled and applicable military specifications) are maintained by the Office of Flight Assurance Information Center. GSFC personnel can obtain copies of these specifications through their division office from the Information Center, Building 6, Room W43, telephone (301) 286-7240.

Contractors, approved domestic and foreign experimenters, and international cooperative project working groups can obtain copies of the PPL and of reference specifications maintained in the Information Center, except military specifications, by submitting a written request through their GSFC Project Office.

For all others, copies of the PPL can be obtained from the National Technical Information Service (NTIS), Springfield, VA 22161, or through the Government Information Data Exchange Program (GIDEP) data bank. Requests for military specifications should be directed to:

Standardization Document Order Desk
Building #4, Section D
700 Robbins Avenue
Philadelphia, PA 19111-5094

PARTS INFORMATION AND ASSISTANCE

Assistance on parts selection and specifications, manufacturer surveys, incoming inspections, screening tests and evaluations and failure analyses for all part types is available from the Parts Branch, Office of Flight Assurance, (301) 286-6631.

For general evaluation information on electronic parts and part qualifications, contact the Parts Branch QPLD Administrator at (301) 286-5640 or a Parts Branch specialist via (301) 286-6631.

Assistance on electronic parts problems and questions related to a specific project should be directed to the Project Parts Engineer supporting the project. His or her name can be obtained by contacting the Parts Branch at (301) 286-6631.

TABLE OF CONTENTS

Issuance of PPL-21	i
Preface	vi
SECTION 01 - CAPACITORS	
Summary of Preferred Capacitors	01-1
MIL-C-20 Capacitors, Fixed, Ceramic Dielectric, Temperature Compensating, Established Reliability	01-2
MIL-C-123 Capacitors, Fixed, Ceramic Dielectric, Temperature Stable and General Purpose, High Reliability	01-3
MIL-C-23269 Capacitors, Fixed, Glass Dielectric, Established Reliability	01-5
MIL-C-39003 Capacitors, Fixed, Tantalum (Solid) Electrolytic, Polarized, Established Reliability	01-6
MIL-C-39006 Capacitors, Fixed, Tantalum (Nonsolid) Electrolytic, Hermetically Sealed, Established Reliability	01-7
MIL-C-39014 Capacitors, Fixed, Ceramic Dielectric, Established Reliability	01-9
MIL-C-55365 Capacitors, Chip, Fixed, Tantalum, Established Reliability	01-10
MIL-C-55681 Capacitors, Chip, Multiple Layer, Fixed, Unencapsulated, Ceramic Dielectric, Established Reliability	01-11
MIL-C-83421 Capacitors, Fixed, Metallized Plastic Film Dielectric, Hermetically Sealed, Established Reliability	01-13
MIL-C-87217 Capacitors, Fixed, Supermetallized Plastic Film Dielectric, Direct Current for Low Energy, High Impedance Applications, Hermetically Sealed in Metal Cases, High Reliability	01-14
SECTION 02 - CONNECTORS	
Summary of Preferred Connectors	02-1
MSFC 40M38277 Circular Connectors, High Density, Low Silhouette, Low Outgassing, Bayonet Coupled, -150°C to +200°C	02-3
MSFC 40M38298 Circular Connectors, Miniature, Low Outgassing, Bayonet Coupled, - 150°C to +200°C	02-4
MSFC 40M39569 Circular Connectors, Low Outgassing, Bayonet Coupled, 150°C to +200°C	02-5
MIL-C-38999 Series I and II, Circular Connectors, Bayonet Coupled, -65°C to +200°C ..	02-7
MIL-C-38999 Series III & IV, Circular Connectors, -65°C to +200°C	02-9
MIL-C-26482 Series 2, Circular Connectors, Bayonet Coupled, -55°C to +200°C	02-11
MIL-C-5015 Circular Connectors, Threaded Coupling, Rear Release Contacts, -55°C to +200°C	02-13
GSFC S-311-P-4 D-Subminiature Connectors, Crimp Removable Contacts, -55°C to +125°C	02-14

TABLE OF CONTENTS

SECTION 02 - CONNECTORS (continued)

GSFC S-311-10 D-Subminiature Connectors, Solder Contacts, -55°C to +125°C	02-15
MIL-C-24308 D-Subminiature Connectors, -55°C to +125°C	02-16
GSFC S-311-P-4/09 and MIL-C-24308 D-Subminiature Connectors, Standard Density Size 20 Crimp Contacts	02-17
GSFC S-311-P-4/07 and MIL-C-24308 D-Subminiature Connectors, High Density Size 22D Crimp Contacts.....	02-18
GSFC S-311-P-10 and MIL-C-24308 D-Subminiature Connectors, Standard Density Size 20 Solder Contacts.....	02-19
GSFC S-311-P-4/05 and S-311-P-10 D-Subminiature Connectors, Combination Power, Coaxial and High Voltage Contacts	02-20
MIL-C-55302 Printed Circuit Connectors, -65°C to +125°C.....	02-21
MIL-C-39012 Radio Frequency Connectors, SMA Series Coaxial, 50 Ohms	02-24
MIL-C-83517 Radio Frequency Connectors, Series SMA Transmission Line, 50 Ohms...	02-27
MIL-C-83513, Microminiature Connectors, Pre-Terminated, Crimp Contacts or Solder Contacts, -55°C to +125°C	02-29
MIL-C-83513, Microminiature Printed Circuit Connectors, -55°C to +125°C	02-30
GSFC S-311-P-718 Satellite Interface Connectors, Receptacle, Rectangular, Polarized Shell, EMI Shielded, Crimp Removable, Pin Contacts.....	02-31
MIL-C-39029 Contacts, Electrical Connector, Crimp Removable.....	02-37
MIL-C-85409 Connector Accessories, Electrical	02-39

SECTION 03 - FILTERS

Summary of Preferred Filters.....	03-1
MIL-F-28861, Filters, Radio Frequency/Electromagnetic Interference Suppression	03-2

SECTION 04 - FUSES

Summary of Preferred Fuses.....	04-1
MIL-F-23419 Fuses, Subminiature (Axial Leads)	04-2

SECTION 05 - COILS/INDUCTORS

Summary of Preferred Coils/Inductors.....	05-1
MIL-C-39010, Coils, Fixed, Radio Frequency, Molded, Established Reliability.....	05-2
MIL-C-83446, Chip, Fixed or Variable, Radio-Frequency	05-3

TABLE OF CONTENTS

SECTION 06 - RELAYS

Summary of Preferred Relays	06-1
Relays, Latching.....	06-2
Relays, Nonlatching.....	06-3

SECTION 07 - RESISTORS

Summary of Preferred Resistors	07-1
S-311-P-672 Resistors, Film, High Voltage	07-2
S-311-P-683 Resistors, Film, High Voltage, Precision	07-3
MIL-R-742 Resistors, Fixed, Low TC, Precision, Radial-Lead	07-4
MIL-R-39005 Resistors, Fixed, Wirewound (Accurate), Established Reliability	07-5
MIL-R-39007 Resistors, Fixed, Wirewound (Power Type), Established Reliability	07-6
MIL-R-39008 Resistors, Fixed, Composition (Insulated), Established Reliability	07-8
MIL-R-39009 Resistors, Fixed, Wirewound (Power Type, Chassis Mounted), Established Reliability.....	07-10
MIL-R-39015 Resistors, Variable, Wirewound (Lead Screw Actuated), Established Reliability	07-12
MIL-R-39017 Resistors, Fixed, Film (Insulated), Established Reliability	07-13
MIL-R-55182 Resistors, Fixed, Film, Established Reliability.....	07-14
MIL-R-55342 Resistors, Fixed, Film, Chip, Established Reliability	07-17
MIL-R-83401 Resistors, Networks, Fixed, Film	07-19

SECTION 08 - DIODES

Summary of Preferred Diodes.....	08-1
Power Rectifiers.....	08-2
Schottky Barrier Rectifiers	08-3
Fast Recovery Rectifiers.....	08-3
Switching Diodes	08-5
Zener Diodes.....	08-6
Voltage Reference Diodes	08-9
High Voltage Diodes.....	08-10
Bi- Directional Transient Suppressor Diodes	08-11
Unidirectional Transient Suppressor Diodes	08-13
Thyristors (SCRs)	08-17
Current Regulator Diodes.....	08-18
Varactor Diodes.....	08-19

TABLE OF CONTENTS

SECTION 08 - DIODES (continued)

Full Wave Bridge Rectifiers.....	08-20
Multiple Diode Arrays.....	08-21
Light Emitting Diodes	08-21
Small Signal Diodes	08-22

SECTION 09 - TRANSISTORS

Summary of Preferred Transistors	09-1
NPN Low Power Transistors.....	09-2
PNP Low Power Transistors	09-3
NPN High Power Transistors	09-4
PNP Power Transistors	09-6
RF Transistors.....	09-7
Quad Low Power MOSFETs	09-7
N-Channel Power MOSFETs	09-8
P-Channel Power MOSFETs.....	09-10
PNP Darlington Transistors.....	09-10
NPN Darlington Transistors	09-11
N-Channel FETs	09-11
P-Channel FETs	09-12
Silicon Dual Transistors, Complementary	09-12
Optocouplers	09-13

SECTION 10 - MICROCIRCUITS

Summary of Preferred Microcircuits.....	10-1
MIL-M-38510 Part Number Explanation.....	10-2
MIL-I-38535 SMD One-Part-One Part Number Explanation.....	10-2
Low Power Schottky: 54LS Series.....	10-3
Advanced Low Power Schottky: 54ALS Series.....	10-5
Digital CMOS: 4000B Series.....	10-5
Advanced Schottky: 54F Series	10-6
CMOS High-Speed: 54HC/HCT Series	10-7
Advanced CMOS Technology: 54AC/ACT Series.....	10-8
Bipolar and MOS Memories.....	10-9
MOS Microprocessors and Interface Peripherals	10-9
Semi-Custom Bipolar Array Logic	10-10
Semi-Custom CMOS Gate Array	10-10

TABLE OF CONTENTS

SECTION 10 - MICROCIRCUITS (continued)

Application-Specific-Integrated-Circuits (ASIC) and Masked Gate Arrays	10-11
Linear Bipolar and Bi-FETs.....	10-12
Linear CMOS.....	10-14
Summary of Preferred Hybrid Microcircuits	10-15
MIL-H-38534 SMD One-Part-One Part Number Explanation	10-16
SMD Non-One-Part-One Part Number Explanation.....	10-16
Hybrid Microcircuits	10-17
Notes for Preferred Microcircuits and Hybrids.....	10-19

SECTION 14 - THERMISTORS

Summary of Preferred Thermistors	14-1
S-311-P-18 Thermistors, Insulated and Uninsulated, Nonhermetic.....	14-2
MIL-T-23648 Thermistors, Insulated, Hermetic	14-3

SECTION 15 - TRANSFORMERS

Summary of Preferred Transformers.....	15-1
--	------

SECTION 16 - WIRE AND CABLE

Summary of Preferred Wire and Cable.....	16-1
Insulation Selection Guidelines	16-3
Color Code Designators for Wire According to MIL-STD-681	16-5
MIL-W-22759 Wire, Fluoropolymer-Insulated, Copper or Copper Alloy.....	16-6
MIL-W-22759 Wire, Extruded PTFE, Fluoropolymer Insulated, 600 Volt.....	16-7
MIL-W-22759 Wire, Extruded PTFE, Fluoropolymer Insulated, 1000 Volt.....	16-8
MIL-W-22759 Wire, Extruded ETFE, Fluoropolymer Insulated, 600 Volt	16-9
MIL--W-22759 Wire, Lightweight, Crosslinked, ETFE, Fluoropolymer Insulated, 1000 Volt.....	16-10
MIL-W-22759 Wire, Normal Weight, Crosslinked, ETFE, Fluoropolymer Insulated, 600 Volt.....	16-11
MIL-W-81381 Wire, FEP, Fluorocarbon/Polyimide Insulated, Copper or Copper Alloy ..	16-12
S-311-P-13 Wire, High Voltage, Crosslinked Polyalkene/Crosslinked PVDF Insulated, Tin Coated Copper, 135°C	16-14
MIL-C-27500 Multiconductor Cable, Shielded and Unshielded, Jacketed and Unjacketed	16-15
MIL-C-17, Radio Frequency Coaxial Cable, Flexible and Semi-Rigid	16-16
J-W-1177, Magnet Wire.....	16-17

TABLE OF CONTENTS

SECTION 17 - CRYSTAL OSCILLATORS

Summary of Preferred Crystal Oscillators	17-1
MIL-O-55310 Crystal Oscillators	17-2

SECTION 51 - OPTOELECTRONICS

Summary of Optoelectronic Parts	51-1
Cable, Fiber Optic, Single Channel, Multimode.....	51-2
Connector, Fiber Optic, Single Channel.....	51-3
Termini, Fiber Optic, Multichannel	51-4
Transmitter, Digital Integrated, Fiber Optic, TTL	51-5
Receiver, Digital Integrated, Fiber Optic, TTL	51-5
Transceiver, Fiber Optic, MIL-STD-1773 Interface	51-5
Coupler, Fiber Optic.....	51-6
Diodes, Light Emitting (LEDs).....	51-6

APPENDIX A

Table 01 Additional Testing Requirements for Preferred Capacitors	A-1
Table 02 Additional Testing Requirements for Preferred Connectors	A-2
Table 02A Inspection Criteria for Connectors and Contacts.....	A-5
Table 04 Additional Testing Requirements for Preferred FM08/FM04 Fuses	A-6
Table 07 Additional Testing Requirements for Preferred M83401 Resistor Networks	A-7
Table 08 Additional Testing Requirements for Preferred Diodes	A-7
Table 09 Additional Testing Requirements for Preferred Transistors.....	A-7
Table 10 Additional Testing Requirements for Preferred Microcircuits	A-8
Table 17 Additional Testing Requirements for Preferred Crystal Oscillators.....	A-8

APPENDIX B

Table 01 Capacitor Derating Criteria	B-1
Table 02 Connector Derating Criteria.....	B-1
Table 03 Filter Derating Criteria.....	B-1
Table 04 Fuse Derating Criteria.....	B-2
Table 05 Coil/Inductor Derating Criteria	B-2
Table 06 Relay Derating Criteria	B-3
Table 07 Resistor Derating Criteria	B-4
Table 08 Diode Derating Criteria.....	B-5
Table 09 Transistor Derating Criteria	B-5

TABLE OF CONTENTS

APPENDIX B (Continued)

Table 10 Microcircuit Derating Criteria	B-6
Table 14 Thermistor Derating Criteria	B-6
Table 15 Transformer Derating Criteria	B-6
Table 16 Wire and Cable Derating Criteria	B-7

APPENDIX C

Table 01 Capacitor Screening Requirements	C-1
Table 01A Equivalent Military Specifications	C-4
Table 02 Connector Screening Requirements	C-5
Table 02A Inspection Criteria for Connectors and Contacts	C-12
Table 03 Filter Screening Requirements	C-13
Table 04 Fuse Screening Requirements	C-14
Table 05 Coil/Inductor Screening Requirements	C-15
Table 06 Relay Screening Requirements	C-16
Table 06A Relay Electrical Inspections	C-19
Table 07 Fixed Resistor Screening Requirements	C-23
Table 07A Variable Resistor Screening Requirements	C-25
Table 08 Diode Screening Requirements	C-28
Table 08A Burn-in and Electrical Measurement Requirements for Diodes	C-29
Table 09 Transistor Screening Requirements	C-30
Table 09A Burn-in and Electrical Measurement Requirements for Transistors	C-31
Table 10 Monolithic Integrated Circuit Screening Requirements	C-32
Table 10A Burn-in and Electrical Measurement Requirements for Monolithic ICs	C-33
Table 10B Hybrid Integrated Circuit Screening Requirements	C-36
Table 14 Thermistor Screening Requirements	C-37
Table 15 Transformer Screening Requirements	C-40
Table 16 Wire and Cable Screening Requirements	C-42
Table 17 Crystal Oscillator Screening Requirements, Discrete Component Construction	C-45
Table 17A Crystal Oscillator Screening Requirements, Hybrid Microcircuit Construction	C-47
Table 17B Additional Electrical Measurements	C-49
Section 51 Recommended Screening Guidelines for Optoelectronic Parts	C-51
Table 51-01 Screening Guidelines for Detectors and Emitters	C-51

TABLE OF CONTENTS

APPENDIX C (continued)

Table 51-01A Burn-In Conditions and Electrical and Optical Parameters for Detectors and Emitters	C-52
Table 51-02 Screening Guidelines for Transmitters and Receivers.....	C-53
Table 51-02A Electrical and Optical Parameter Measurements for Optical Transmitters and Receivers	C-53
Table 51-03 Screening Guidelines for Optical Connectors	C-54
Table 51-03A Visual and Mechanical Inspections for Optical Connectors	C-54
Table 51-04 Screening Guidelines for Optical Cables.....	C-55
Table 51-04A Visual and Mechanical Requirements for Optical Cables.....	C-55

APPENDIX D

Radiation Effects.....	D-1
Table I Total Dose Radiation Testing for Goddard Projects.....	D-7
Table II Proton and Heavy Ion Testing for Single Event Phenomena	D-14

APPENDIX E

GSFC Procurement Specifications.....	E-1
--------------------------------------	-----

TABLE OF CONTENTS

THIS PAGE INTENTIONALLY LEFT BLANK

Summary of Preferred Capacitors (Note 1)

Control Specification	Military Style	Description	Package	Capacitance Range		Voltage Range (Volts, dc)		FRL		Refer to Page No.
				Min	Max	Min	Max	Grade 1	Grade 2	
MIL-C-20	CCR	Fixed, ceramic, temperature compensating	Molded	1.0 pF	0.082 μF	50	200	S	R, P	01-2
MIL-C-123	CKS	Fixed, ceramic	Molded and Unencapsulated	1.0 pF	1.0 μF	50	100	(Note 2)	(Note 2)	01-3
MIL-C-23269	CYR	Fixed, glass	Hermetic	0.5 pF	0.01 μF	100	100	S	S	01-5
MIL-C-39003	CSR, CSS	Fixed, tantalum (solid) electrolytic	Hermetic	0.0047 μF	560.0 μF	10	75	C	B	01-6
MIL-C-39006	CLR	Fixed, tantalum (non-solid) electrolytic	Hermetic	0.12 μF	1500.0 μF	10	300	R	P	01-7
MIL-C-39014	CKR	Fixed, ceramic	Molded	10.0 pF	0.47 μF	50	200	(Note 3)	S	01-9
MIL-C-55365	CWR	Chip, fixed, tantalum	Unencapsulated	0.10 pF	100.0 μF	4	50	C	B	01-10
MIL-C-55681	CDR	Chip, fixed, ceramic dielectric	Unencapsulated	10.0 pF	0.47 μF	50	500	S	R, P	01-11
MIL-C-83421	CRH	Fixed, metalized plastic film, DC, AC	Hermetic	0.001 μF	22.0 μF	30	400	S	R	01-13
MIL-C-87217	CHS	Fixed, supermetallized, plastic film, DC, low energy, high impedance	Hermetic	0.001 μF	10.0 μF	30	100	(Note 2)	(Note 2)	01-14

Notes:

1. Detail specifications must be consulted to determine available capacitance values, tolerances and characteristics. All combinations are not available.
2. Failure rate levels (FRLs) are not applicable for these parts. MIL-C-123 and MIL-C-87217 capacitors are preferred for Grade 1 and 2 applications.
3. MIL-C-39014 capacitors are not preferred for Grade 1 applications. Use MIL-C-123 parts.

MIL-C-20 Capacitors

Fixed, Ceramic Dielectric, Temperature Compensating, Established Reliability

CCR**	C*	XYZ	X	X
Style - CCR identifies the MIL-C-20 capacitor and ** identifies the capacitor style.	Temperature Coefficient C=Nominal value=0ppm/°C *=Tolerance (ppm/°C) CG = 30 CH = 60 CJ = 120 CK = 250 CX = Not practically measurable	Capacitance in pF XY=Significant digits Z=number of zeros For values less than 10pF, X and Z= Significant digits , Y=decimal point (R) (Note 1)	Capacitance Tolerance B = ± 0.1pf C = ± 0.25pf D = ± .5pf F = ± 1% G = ±2% J = ± 5% K = ± 10%	Failure Rate Level - (% per 1000 hours) P=0.1 R=0.01 S=0.001

Part Number	Detail Specification MIL-C-20	Style	Capacitance		Rated Voltage (Volts, dc) (Note 2)	Dissipation Factor (%)	Temperature		Configuration		FRL	
			Range (pF) (Note 1)	Tolerances Available			Range (°C)	Characteristics Available	Case Type	Lead Type	Grade 1 (Note 3)	Grade 2
CCR05C*XYZ XX CCR06C*XYZ XX CCR07C*XYZ XX CCR08C*XYZ XX	/35 /36 /37 /38	CCR05 CCR06 CCR07 CCR08	1.0-3,300 360-10,000 2,200-22,000 3,900-68,000	B,C,D,F,G,J F,G,J,K F,G,J,K G,J,K	50, 100, 200	0.15	-55 to +125	CG,CH,CJ,CK,CX CG CG CG	Rect molded	Radial	S	P,R
CCR75C*XYZ XX CCR76C*XYZ XX CCR77C*XYZ XX CCR78C*XYZ XX CCR79C*XYZ XX	/27 /28 /29 /30 /31	CCR75 CCR76 CCR77 CCR78 CCR79	1.0-680 82-1,000 150-5,600 820-27,000 3,900-82,000	B,C,D,F,G,J F,G,J F,G,J,K F,G,J,K F,G,J,K				CG,CH,CJ,CK,CX CG CG CG CG	Tubular molded	Axial		

Notes:

1. See applicable MIL-C-20 detailed specification for capacitance values.
2. For low voltage applications (<10 volts dc), capacitor rated voltage shall be at least 100 volts dc.
3. For Grade 1 low voltage applications, perform lot sample testing per Group B, Subgroup 2, of MIL-C-123.

MIL-C-123 Capacitors (Page 1 of 2)
Fixed, Ceramic Dielectric, Temperature Stable and General Purpose, High Reliability

Part Number Explanation:					
M123 Military Specification Number A= Modification XX= Detail Specification	B* Characteristic at Rated Voltage BP = ± 30ppm/°C BX = +15%, -20% BR = +15%, -10%	X Voltage B = 50V C = 100V D = 200V	XYZ Capacitance in pF XY=Significant digits Z=number of zeros For values less than 10pF, X and Z= Significant digits, Y=Decimal point (R) in picofarads (Note 1)	X Capacitance Tolerance C = ± 0.25% D = ± 0.50% F = ± 1.0% J = ± 5.0% K = ± 10.0%	X Termination (Note 2)

Part Number	Detail Specification MIL-C-123	Style CKS	Capacitance		Rated Voltage (Volts, dc)	Dissipation Factor (%)	Temperature		Configuration		Grade
			Range (pF)	Tolerances Available			Range (°C)	Characteristics Available	Case Type	Lead Type	
M123A01BXXXXXXXX	/1	05	4.7-10,000	C,D,F,J,K	50, 100	(Note 3)	-55 to +125	See Table I of MIL-C-123 and QPL-123	Molded Rectangular	Radial	(Note 4)
M123A02BXXXXXXXX	/2	06	270-470,000	F,J,K	50, 100				Molder Rectangular	Radial	
M123A03BXXXXXXXX	/3	07	2700-1,000,000	F,J,K	50, 100				Molded Rectangular	Radial	
M123A04BXXXXXXXX	/4	11	4.7-4700	C,D,F,J,K	50, 100				Molded Tubular	Axial	
M123A05BXXXXXXXX	/5	12	110-10,000	F,J,K	50, 100				Molded Tubular	Axial	
M123A06BXXXXXXXX	/6	14	1100-47,000	F,J,K	50				Molded Tubular	Axial	
M123A07BXXXXXXXX	/7	15	1100-180,000	F,J,K	50				Molded Tubular	Axial	
M123A08BXXXXXXXX	/8	16	2400-1,000,000	F,J,K	50, 100				Molded Tubular	Axial	
M123A10BXXXXXXXX	/10	51	1.0-4700	C,D,F,J,K	50				Unencapsulated Chip	Leadless	
M123A11BXXXXXXXX	/11	52	300-47,000	F,J,K	50				Unencapsulated Chip	Leadless	
M123A12BXXXXXXXX	/12	53	300-100,000	F,J,K	50				Unencapsulated Chip	Leadless	
M123A13BXXXXXXXX	/13	54	1100-470,000	F,J,K	50				Unencapsulated Chip	Leadless	
M123A16BXXXXXXXX	/16	22	1.0-100,000	D,F,J,K	50, 100, 200				Molded Rectangular	DIP	
M123A17BXXXXXXXX	/17	23	560-220,000	F,J,K	50, 100, 200				Molded Rectangular	DIP	
M123A18BXXXXXXXX	/18	24	120,000-470,000	K	50, 100				Molded Rectangular	DIP	

See notes on page 01-4.

MIL-C-123 Capacitors (Page 2 of 2)
Fixed, Ceramic Dielectric, Temperature Stable and General Purpose, High Reliability

Notes:

1. See applicable MIL-C-123 detailed specification for capacitance values.
2. See MIL-C-123, Table IV. The available terminations are stated in the QPL. Termination type W for MIL-C-123 non leaded style capacitors is not permitted as this termination permits the use of pure tin.
3. Dissipation factor for BX and BR \leq 2.5 percent and for BP \leq 0.15 percent.
4. Failure Rate Level (FRL) not applicable. These parts may be used in Grade 1 and Grade 2 applications

MIL-C-23269 Capacitors
Fixed, Glass Dielectric, Established Reliability

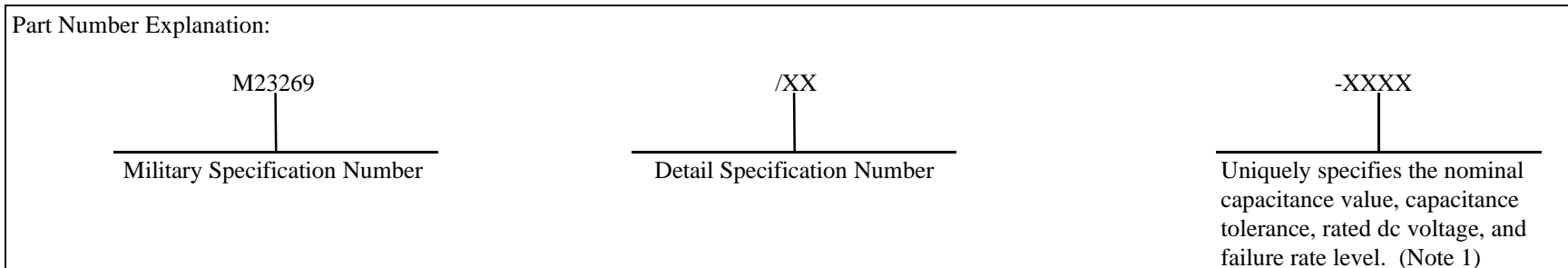

Part Number	Detail Specification	Style (Note 2)	Capacitance		Working Voltage (Vdc) @ +125°C	Maximum Dissipation Factor (%)	Temperature		Lead Type	FRL Grade 1 and 2
			Range (pF)	Tolerances ±			Range (°C)	Coefficient (ppm/°C)		
M23269/01-XXXX	MIL-C-23269/1	CYR10	0.5-300	0.25 pF 0.50 pF 1%, 2%, 5%	100	0.1	-55 to +125	140 ±25	Axial Wire Lead	S
M23269/02-XXXX	MIL-C-23269/2	CYR15	220-1,200	1%, 2%, 5%						
M23269/03-XXXX	MIL-C-23269/3	CYR20	560-3,300							
M23269/04-XXXX	MIL-C-23269/4	CYR30	3,600-6,200							

Notes:

1. See applicable MIL-C-23269 detailed specification for capacitance values and tolerances.
2. Lead material and coating are specified in the detailed specification sheet for each device type.

MIL-C-39003 Capacitors

Fixed, Tantalum (Solid) Electrolytic, Polarized, Established Reliability

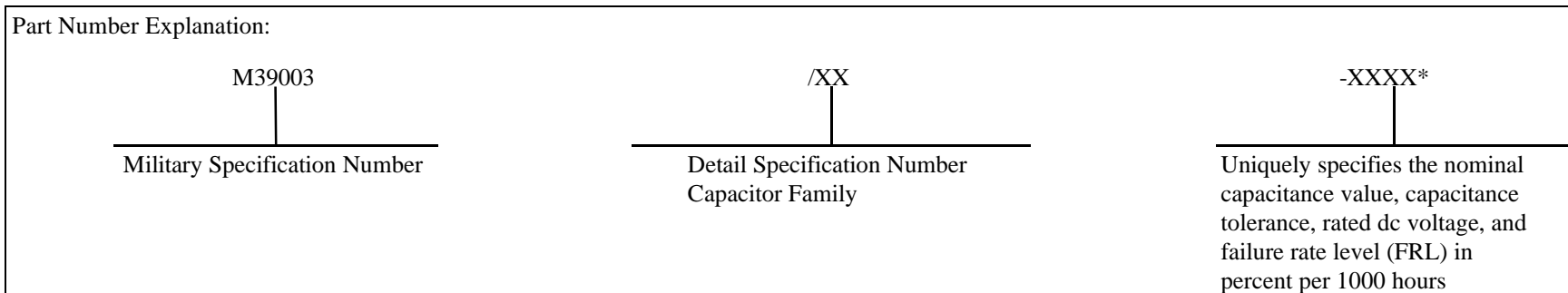

Part Number (Notes 1, 2)	Detail Specification	Style	Capacitance		Rated Voltage (Vdc)	Operating Temperature Range (°C)	Configuration		FRL		
			Range (µF)	Tolerances (±%)			Case Type	Lead		Grade 1	Grade 2
								Type	Material		
M390003/10-XXXX* (Note 3)	MIL-C-39003/10 Polarized	CSS13	0.12 - 220.0	10	10, 15 20, 35 50, 75	-55 to +125	Tubular	Axial	Tin-lead coated nickel; Solder coated nickel	C	B
M390003/01-XXXX (Note 4)	MIL-C-39003/1 Polarized	CSR13	0.0047 - 4.7	10, 20	50				Tin-lead coated nickel; Solder coated nickel	C (Note 5)	B
M390003/02-XXXX (Note 4)	MIL-C-39003/2 Polarized	CSR09	0.047 - 15.0	10	10, 20 35, 50, 75				Nickel-iron alloy	C (Note 5)	B
M390003/09-XXXX (Note 4)	MIL-C-39003/9 Nonpolarized	CSR21	5.6-330	5, 10, 15	6, 10, 15 20, 35, 50				Tin-lead coated nickel	C (Note 5)	B
M390003/10-XXXX* (Note 3)	MIL-C-39003/10 Polarized	CSS33	1.2 - 560.0	10	10, 20 35, 50				Tin-lead coated nickel; Solder coated nickel	C	B

Notes:

1. Solid Tantalum Capacitors are subject to inrush current failures. Effective series resistance for MIL-C-39003 capacitors should be at least 0.3 ohms/volt or 1 ohm whichever is greater, for Grade 1 and at least 0.1 ohms/volt or 1 ohm, whichever is greater, for Grade 2 applications. MIL-C-39003 capacitors should not be used in power supply filters. MIL-C-39006/22, CLR 79 or MIL-C-39006/25, CLR 81 style parts are preferred for power supplies.
2. Parts covered by this specification contain internal soldered connections which may reflow during installation. The A, A1, B, B1 case sizes are particularly susceptible and special precautions such as heat sinking are recommended when soldering onto boards.
3. The symbol * completes the dash number thus: * = S for Sleeved, U for Unsleeved.
4. CSR09, CSR13 and CSR21 capacitors are sleeved (insulated case).
5. All CSR13, CSR09, and CSR21 Grade 1 capacitors must be subjected to the surge current test in accordance with Appendix A.

MIL-C-39006 Capacitors (Page 1 of 2)
Fixed, Tantalum (Nonsolid) Electrolytic, Hermetically Sealed, Established Reliability

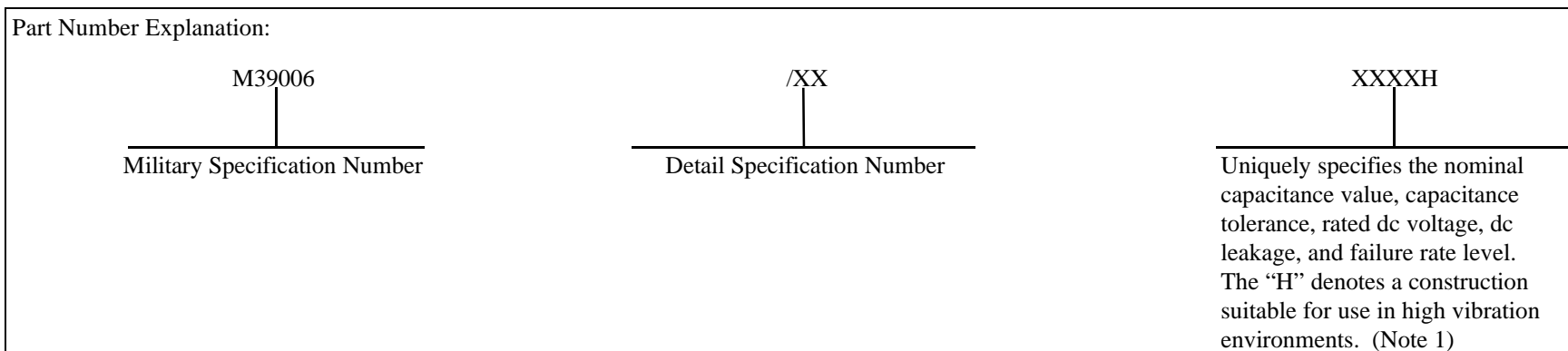

Part Number	Number Specification	Style	Capacitance		Working Voltage (Vdc) @ +85°C	Operating Temperature Range (°C)	FRL	
			Range (µF)	Tolerances (±%)			Grade 1	Grade 2
M39006/01-XXXXXH	MIL-C-39006/1 Polarized/Etched Foil	CLR25	8 to 580	+75, -15	15, 25 or 30	-55 to +125	(Note 2)	P
			3 to 150	+50, -15	50 or 75			
			1 to 70	+30, -15	100 or 150			
M39006/02-XXXXXH	MIL-C-39006/2 Nonpolarized/Etched Foil	CLR27	4.5 to 350	+75, -15	15, 25 or 30			
			1.5 to 80	+50, -15	50 or 75			
			0.5 to 35	+30, -15	100 or 150			
M39006/03-XXXXXH	MIL-C-39006/3 Polarized/Plain Foil	CLR35	4.5 to 160	±20	15			
			3 to 100	±20	25			
			2.5 to 85	±20	30			
			68	±20	35			
			1.5 to 55	±20	50			
			1 to 40	±20	75			
			0.8 to 30	±20	100			
0.5 to 20	±20	150						

See notes on page 01-8.

MIL-C-39006 Capacitors (Page 2 of 2)
Fixed, Tantalum (Nonsolid) Electrolytic, Hermetically Sealed, Established Reliability

Part Number	Detail Specification	Style	Capacitance		Working Voltage (Vdc) @ +85°C	Operating Temperature Range (°C)	FRL	
			Range (µF)	Tolerances (±%)			Grade 1	Grade 2
M39006/04-XXXXH	MIL-C-39006/4 Nonpolarized/Etched Foil	CLR37	2.5 to 100	20	15	-55 to +125	(Note 2)	P
			1.5 to 60	20	25			
			1.4 to 45	20	30			
			0.8 to 30	20	50			
			0.5 to 20	20	75			
			0.4 to 15	20	100			
			0.25 to 10	20	150			
			0.15 to 7.5	15	200			
			0.15 to 6	15	250			
			0.12 to 4.7	15	300			
M39006/22-XXXXH	MIL-C-39006/22 Polarized/Sintered Slug	CLR79	20 to 750	5, 10, 20	10	-55 to +125	R	P
			15 to 540	5, 10, 20	15			
			8 to 300	5, 10, 20	30			
			5 to 160	5, 10, 20	50			
			3.5 to 110	5, 10, 20	75			
			2.5 to 86	5, 10, 20	100			
			1.7 to 56	5, 10, 20	125			
M39006/25-XXXXH	MIL-C-39006/25 Polarized/Sintered Slug Extended Range	CLR81	150 to 1500	10, 20	10	-55 to +125	R	P
			100 to 1000	10, 20	15			
			68 to 680	10, 20	25			
			56 to 560	10, 20	30			
			33 to 330	10, 20	50			
			27 to 270	10, 20	60			
			22 to 220	10, 20	75			
			10 to 120	10, 20	100			
6.8 to 82	10, 20	125						

Notes:

1. CLR capacitors are susceptible to vibration failures if not procured with the H suffix (high vibration construction), and CLR79 and CLR81 capacitors can additionally be a source of transient potentials (intermittent shorts) during vibration stimuli.
2. There are currently no QPL manufacturers qualified to FRL "R" for these parts.

MIL-C-39014 Capacitors
Fixed, Ceramic Dielectric, Established Reliability

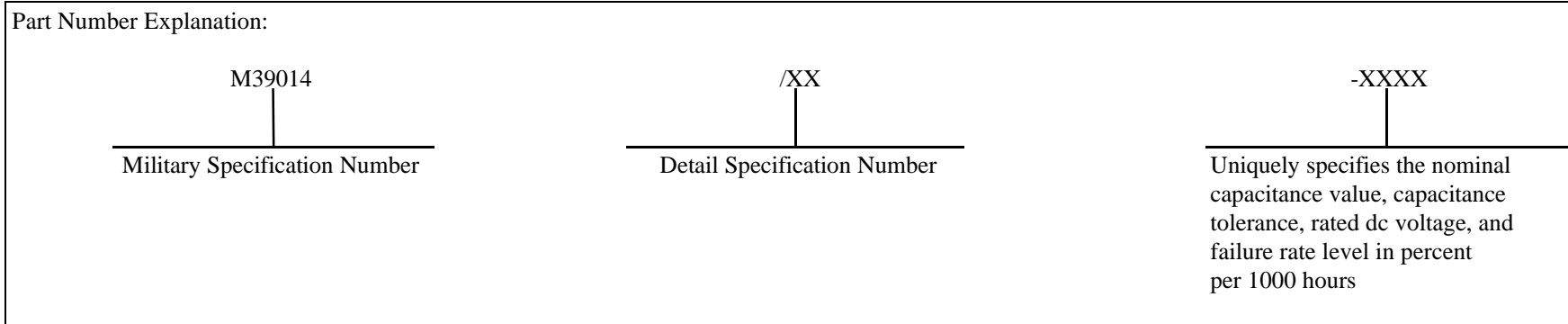

Part Number	Detail Specification	Style	Capacitance		Rated Voltage (Vdc) @ +125°C (Note 1)	Maximum Dissipation Factor (%)	Operating Temperature Range (°C)	Configuration		FRL Grade 2 (Note 2)
			Range (pF)	Tolerances (±%)				Case Type	Lead Type	
M39014/01-XXXX	MIL-C-39014/1	CKR05	10 - 100,00	10, 20	50, 100, 200	2.5	-55 to + 125	Molded	Radial	S
M39014/02-XXXX	MIL-C-39014/2	CKR06	1,200 - 470,000		50, 100					
M39014/05-XXXX	MIL-C-39014/5	CKR11	10 - 10,000							
		CKR12	5,600 - 47,000							
		CKR14	12,000 - 100,000							
		CKR15	56,000 - 470,000	100	2.5, 3.0	Molded	DIP			
M39014/22-XXXX	MIL-C-39014/22	CKR22	1-100,000	2.5, 5	50, 100, 200			.15, 3.0		
		CKR23	560-22,000	10, 20						
		CKR24	120,000-1,000,000							

Notes:

1. For low voltage application (<10 volts dc), capacitor rated voltage shall be at least 100 volts dc.
2. MIL-C-39014 capacitors are not preferred for Grade 1 applications. MIL-C-123 capacitors are preferred.

MIL-C-55365 Capacitors Chip, Fixed, Tantalum, Established Reliability

Part Number Explanation:

CWRXX	X	X	XXX	X	X
Style CWR identifies the MIL-C-55365 capacitor and XX identifies the capacitor style.	Voltage - A single letter symbol identifies the voltage (rated, derated, and surge) as follows:	Termination Finish B: Gold C: Hot solder Dipped	Capacitance in picofarads The first two digits represent significant figures and the last digit specifies the number of zeros to follow.	Capacitance tolerance J = $\pm 5\%$ K = $\pm 10\%$ M = $\pm 20\%$	Failure Rate Level Weibull % per 1000 hrs. B = 0.1 C = 0.01

Symbol	Voltage (Volts, dc)		
	Rated (+85°C)	Derated (+125°C)	Surge (+85°C)
C	4	2.7	5.0
D	6	4.0	8.0
F	10	7.0	13.0
H	15	10.0	20.0
J	20	13.0	26.0
K	25	17.0	32.0
M	35	23.0	46.0
N	50	33.0	65.0

Part Number (Note 1)	Detail Specification	Capacitance		Rated Voltage (Vdc) @ +85°C	Operating Temperature Range (°C)	FRL	
		Range (µF)	Tolerances Available			Grade 1 (Note 2)	Grade 2
CWR06XXXXXXXX	MIL-C-55365/4	0.10 - 100.0	J, K, M	C, D, F, H, J, K, M, N	-55 to +125	C	B
CWR09XXXXXXXX	MIL-C-55365/4	0.10 - 100.0	J, K, M	C, D, F, H, J, K, M, N	-55 to +125	C	B

Notes:

1. Solid Tantalum Capacitors are subject to inrush current failures. Effective series resistance for MIL-C-55365 capacitors should be at least 0.3 ohms/volt or 1 ohm whichever is greater, for Grade 1 and at least 0.1 ohms/volt or 1 ohm, whichever is greater, for Grade 2 applications. MIL-C-55365 capacitors should not be used in power supply filters.
2. MIL-C-55365 capacitors shall be subjected to surge current testing in accordance with MIL-C-39003/10 for Grade 1 applications.

MIL-C-55681 Capacitors Chip (Page 1 of 2)
Multiple Layer, Fixed, Unencapsulated, Ceramic Dielectric, Established Reliability

Part Number Explanation:						
CDRYY	BY	XYZ	Y	Y	Y	Y
Style - CDR identifies the MIL-C-55681 capacitor and YY identifies the capacitor style.	Rated temperature (B) and voltage temperature limits (Y) (Note 1) B = -55°C to +125°C Y = P = 0± 30ppm/°C Y = X = +15%, -25% Y = G = 90 ± 20ppm/°C	Capacitance in pF. XY = Significant digits Z = number of zeros For values less than 10pF, X and Z = Significant digits, Y = decimal point (R) (Note 2)	Rated Voltage (Vdc) A = 50 B = 100 C = 200 D = 300 E = 500	Capacitance Tolerance B = ±0.10pF C = ±0.25pF D = ±0.50pF F = ±1% G = ±2% J = ±5% K = ±10% M = ±20%	Termination Finish S = Solder-coated, final M = Palladium-silver N = Silver-nickel-gold U = Base Metallization-Barrier Metal-Solder coated	Failure Rate Level: (% per 1000 hrs) P = 0.1 R = 0.01 S = 0.001

Part Number	Detail Specification	Style	Capacitance		Rated Voltage @ +125°C (Vdc) (Note 3)	Operating Temperature Range (°C)	Rated Temperature & Voltage Temperature Limits	FRL	
			Range (pF) (Note 2)	Tolerances Available				Grade 1 (Note 4)	Grade 2
CDR01BYYYYYYYY	MIL-C-55681/1	CDR01	10-4,700	I, K, M	100	-55 to +125	BX, BP	S	P, R
CDR03BYYYYYYYY		CDR03	330-68,000	I, K, M	50, 100		BX, BP		
CDR04BYYYYYYYY		CDR04	1,200,-180,000	K, M	50, 100		BX		
CDR05BYYYYYYYY	MIL-C-55681/2	CDR05	3,900-330,000	I, K, M	50, 100		BX, BP		
CDR06BYYYYYYYY	MIL-C-55681/3	CDR06	6,800-470,000	J, K, M	50, 100		BX, BP		
CDR11BYYYYYYYY	MIL-C-55681/4	CDR11	0.1-1,000	B, C, D, F G, J, K, M	50		BG, BP		
CDR12BYYYYYYYY		CDR12	0.1-1,000		50				
CDR13BYYYYYYYY		CDR13	0.1-5,100		50, 100, 200				
CDR14BYYYYYYYY		CDR14	6.8-5,100		300, 500				
CDR31BYYYYYYYY	MIL-C-55681/7	CDR31	1.0-18,000	F, J, K, M	50, 100, 200, 300		BX, BP		
CDR32BYYYYYYYY	MIL-C-55681/8	CDR32	1.0-39,000	B, C, D, F, J, K, M	50, 100		BX, BP		
CDR33BYYYYYYYY	MIL-C-55681/9	CDR33	1,000-100,00	F, J, K, M	50, 100	BX, BP			
CDR34BYYYYYYYY	MIL-C-55681/10	CDR34	2,200-180,000	F, J, K, M	50, 100	BX, BP			
CDR35BYYYYYYYY	MIL-C-55681/11	CDR35	4,700-470,000	F, J, K, M	50, 100	BX, BP			

See notes on page 01-12.

MIL-C-55681 Capacitors Chip (Page 2 of 2)
Multiple Layer, Fixed, Unencapsulated, Ceramic Dielectric, Established Reliability

Notes:

1. Capacitance change is a function of voltage and temperature and is referenced to 25°C and rated voltage.
2. See MIL-C-55681 for capacitance values.
3. For low voltage applications (<10 Vdc), capacitor rated voltage shall be at least 100 volts dc.
4. Additional testing shall be performed in accordance with Appendix A. Test samples shall not be used as flight parts.

MIL-C-83421 Capacitors (Note 1)
Fixed, Metallized Plastic Film Dielectric, Hermetically Sealed, Established Reliability

Part Number Explanation:

M83421	/XX	- X	XXX	X
Military Specification Number	Detail Specification Number	Style 1 = CRH01 2 = CRH02 3 = CRH03 4 = CRH04 5 = CRH05	Uniquely specifies the capacitance value, capacitance tolerance, ac ratings, and physical dimensions of the capacitor	Failure Rate Level: (% per 1000 hrs.) R = 0.01 S = 0.001

Part Number	Detail Specification	Style (Note 2)	Capacitance		Rated Voltage @ +100°C (Vdc)	Dissipation Factor (% max)	Dielectric Absorption (% max)	Operating Temperature Range (°C)	FRL	
			Range (µF)	Tolerances (±%)					Grade 1	Grade 2
M83421/01-XXXXX (Note 3)	MIL-C-83421/1	CRH01	0.001-22.0	1, 5, 10	30	0.15	0.1	-65 to +100	S	R
		CRH02	0.001-10.0		50					
		CRH03	0.001-10.0		100					
		CRH04	0.001-3.9		200					
		CRH05	0.001-2.0		400					

Notes:

1. These parts shall not be used outside of the limits under INTENDED USE in the notes section of MIL-C-83421. Minimum stored energy in the range 100 to 500 microjoules is recommended to insure clearing. Applications for these capacitors shall be limited to circuits that will provide sufficient energy to insure clearing and that are insensitive to momentary breakdown/clearing actions.
2. Lead material and coating are specified in MIL-C-83421/1.
3. Parts covered by this specification contain internal soldered connections which may reflow during installation. The plastic dielectric in these parts is also temperature sensitive. Special precautions such as heat sinking are recommended when soldering onto boards.

MIL-C-87217 Capacitors
Fixed, Supermetallized Plastic Film Dielectric, Direct Current for Low Energy, High Impedance Applications,
Hermetically Sealed in Metal Cases, High Reliability

Part Number Explanation:

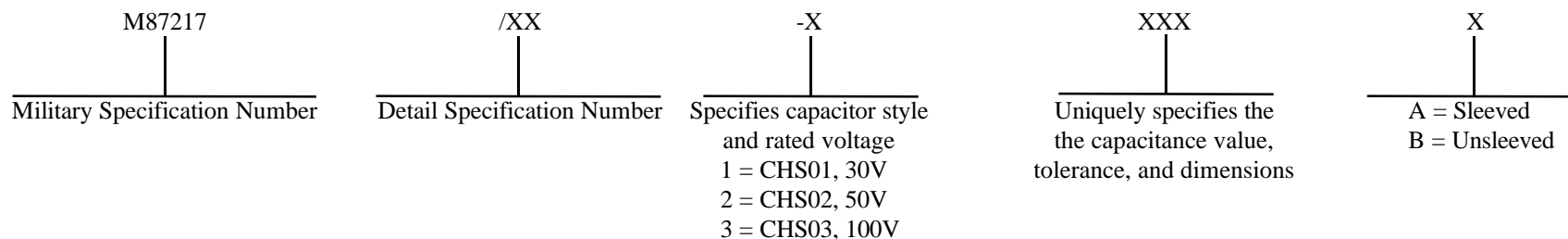

Part Number	Detail Specification	Style (Note 1)	Capacitance		Rated Voltage @ +100°C (Vdc)	Operating Temperature Range (°C)	Grade
			Range (µF)	Tolerances (±%)			
M87217/01-XXXXX (Notes 1, 2)	MIL-C-87217/1	CHS01	0.001 - 10.0	0.25, 0.5,	30	-55 to +100	(Note 3)
		CHS02		1.0, 2.0,	50		
		CHS03		5.0, 10.0	100		

Notes:

1. To ensure clearing of breakdown, it is recommended that the circuit in which capacitors of 0.1 µF and greater capacitance are intended for use should be capable of providing at least 100 microjoules of energy.
2. Parts covered by this specification contain internal soldered connections which may reflow during installation. The plastic dielectric in these parts is also temperature sensitive. Special precautions such as heat sinking are recommended when soldering onto boards.
3. These parts may be used in Grade 1 and Grade 2 applications.

Summary of Preferred Connectors (Note 1) (Page 1 of 2)

Type Designation	Description	Specification	Grade	Refer To Page No.
NLS	Circular, High Density, Miniature, Low Outgassing	MSFC 40M38277	1, 2	02-3
NBS	Circular, Miniature, Low Outgassing	MSFC 40M38298	1, 2	02-4
NB	Circular, Miniature, Low Outgassing	MSFC 40M39569	1, 2	02-5
MS27XXX	Circular, Miniature, Series I, Bayonet Coupled	MIL-C-38999	1, 2	02-7
MS27XXX	Circular, Low Silhouette, Miniature, Series II (Note 2)	MIL-C-38999	1, 2	02-7
D38999/XX	Circular, Miniature, Series III, Self Locking Coupling	MIL-C-38999	1, 2	02-9
D38999/XX	Circular, Miniature, Series IV, Breech Coupling	MIL-C-38999	1, 2	02-9
MS34XX	Circular, Miniature, Series 2 (Notes 3, 4)	MIL-C-26482	2	02-11
MS345X	Circular, Crimp Rear Release Contacts (Note 4)	MIL-C-5015	2	02-13
311P409	D-Subminiature Type, Removal Crimp Contacts, Low Residual Magnetism	GSFC S-311-P-4/09	1, 2	02-14, 02-17
311P407	D-Subminiature Type, High Density, Crimp Removable Contacts, Low Residual Magnetism	GSFC S-311-P-4/07	1, 2	02-14, 02-18
311P405	D-Subminiature Type, Combination Power, Coaxial and High Voltage Contacts, Low Residual Magnetism	GSFC S-311-P-4/05	1, 2	02-14, 02-20
311P10	D-Subminiature Type, Solder Contacts, Low Residual Magnetism Standard Power and Combination Inserts	GSFC S-311-P-10	1, 2	02-15, 02-19, 02-20
M24308/XX	D-Type Subminiature Solder or Removable Crimp Contacts (Note 5)	MIL-C-24308	2	02-16, 02-17, 02-18, 02-19
M55302/XX	Printed Circuit	MIL-C-55302	2	02-21
M39012/XX	Coaxial, Radio Frequency, Series SMA (Note 6)	MIL-C-39012	2	02-24
M83517/X	Transmission Line, Radio Frequency, Series SMA	MIL-C-83517	2	02-27
M83513/XX	Microminiature, Pre-Terminated Crimp or Solder Contacts	MIL-C-83513	2	02-29
M83513/XX	Microminiature, Printed Circuit Connectors	MIL-C-83513	2	02-30
700-42	Power Connectors, Satellite Interface, Crimp Removable Contacts	GSFC S-311-P-718	1, 2	02-31
M39029/XX	Contacts, Electrical Connector	MIL-C-39029	2	02-37
M85049/XX	Backshell Connector Accessories	MIL-C-85049	1, 2	02-39

See notes on page 02-2.

Index of Preferred Connectors (Note 1) (Page 2 of 2)

Notes:

1. The use of connectors with cadmium or zinc plating, which tends to sublime in a vacuum, is prohibited. Gold over nickel or electroless nickel are the preferred platings for GSFC applications. For contacts, gold plating with a 50 microinch thickness over the engagement area is the GSFC preferred finish.
2. Use MSFC NLS type as first choice where low outgassing is a requirement.
3. Use MSFC NB type as first choice where low outgassing is a requirement.
4. For circular connectors where outgassing is not a concern, use MIL-C-38999 connectors as a first choice. Use MIL-C-5015 where large contacts and high currents are a requirement.
5. Use GSFC S-311-P-4 or S-311-P-10 for first choice where low residual magnetism is a requirement.
6. MIL-C-39012 Series N and TNC are not preferred parts for GSFC programs due to concerns with atomic oxygen corrosion of the silver plating when used in earth orbits.

**MSFC 40M38277 Circular Connectors, High Density, (Notes 1 and 2)
Low Silhouette, Low Outgassing, Bayonet Coupled, -150°C to +200°C**

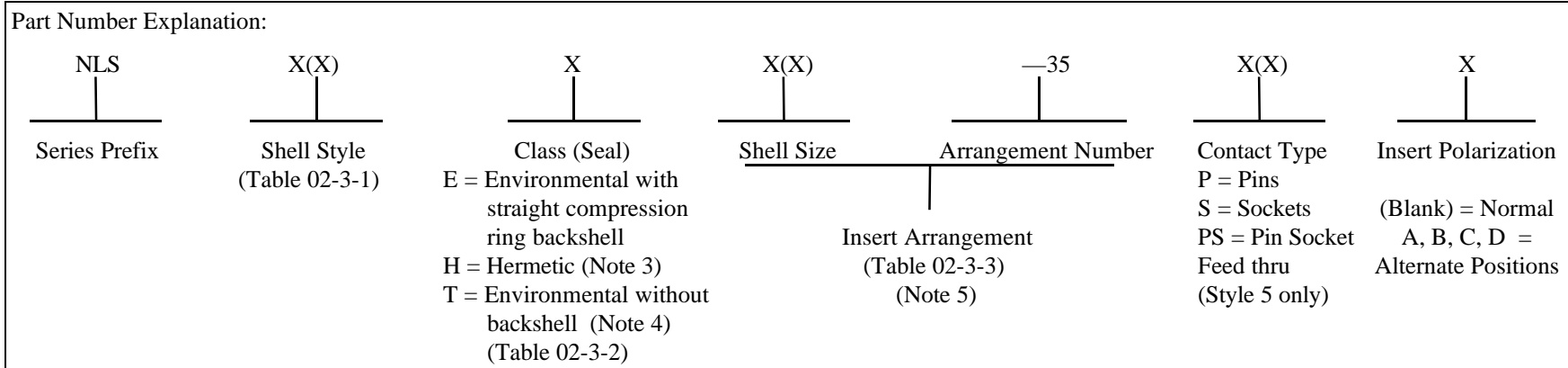

Table 02-3-1 Connector Styles

0 = Receptacle flange mount	6 = Plug, cable mount
3 = Receptacle, solder mount hermetic	6G = Plug, cable mount with RFI Grounding finders
5 = Bulkhead feedthrough, hermetic jam nut mount (Double sided connector)	6W = Plug, cable mount, without coupling ring & backshell
	7 = Receptacle, jam nut mount

Table 02-3-2

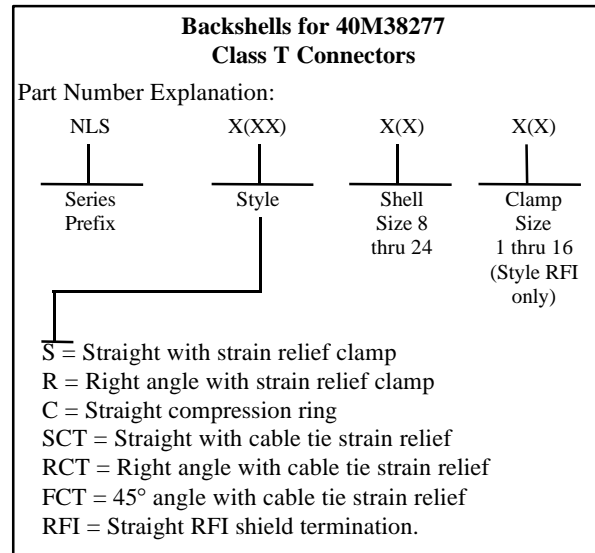

Table 02-3-3

Insert Arrangement	No. of Contacts (All size 22D)
8 - 35	6
10 - 35	13
12 - 35	22
14 - 35	37
16 - 35	55
18 - 35	66
20 - 35	79
22 - 35	100
24 - 35	128

Notes:

1. Connectors may be used in Grade 1 and 2 applications.
2. Connectors are supplied with contacts.
3. Temperature range for hermetically sealed connectors is -100°C to +150°C.
4. Backshell strain relief must be procured separately for Class T connectors.
5. Insert arrangement designation consists of shell size and arrangement number. For 40M38277 connectors, only size 22D contacts are available.

**MSFC 40M38298 Circular Connectors, Miniature, (Note 1)
Low Outgassing, Bayonet Coupled, -150°C to +200°C**

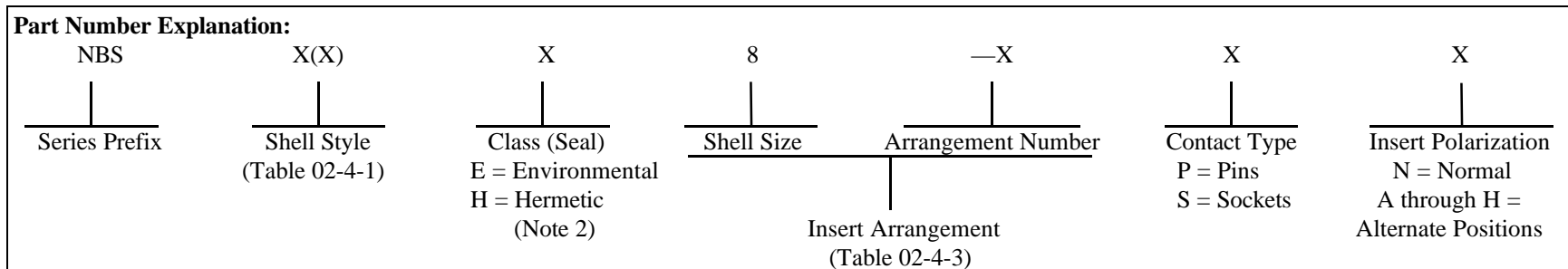

Table 02-4-1 Connector Styles

0 = Receptacle, flange mount hermetic	6G = Plug, cable mount with RFI grounding fingers (Notes 3, 4)	8G = Plug, cable mount, with right angle RFI backshell and RFI grounding fingers
3 = Receptacle, surface mount hermetic	7 = Receptacle, jam nut mount (Notes 3, 4)	9 = Plug with straight RFI backshell (Notes 5, 6)
6 = Plug, cable mount (Notes 3, 4)	8 = Plug cable mount, with right angle RFI backshell	9G = Plug with straight RFI backshell and RFI grounding fingers (Notes 5, 6)

Table 02-4-2

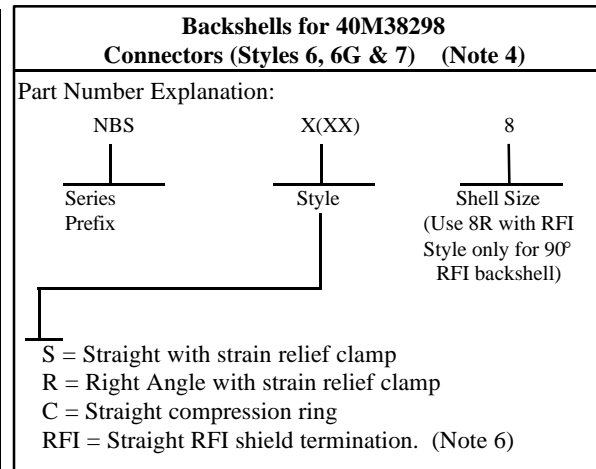

Table 02-4-3 (Note 7)

Insert Arrangement	No. of Contacts (All size 20)
8 - 2	2
8 - 3	3
8 - 4	4

Notes:

1. Connectors may be used in Grade 1 and Grade 2 applications. They are supplied with contacts.
2. Temperature range for hermetically sealed connectors is -100°C to +150°C.
3. When styles 6, 6G and 7, are used in space shuttle missions, only polarization N, A, B, C, D shall be used.
4. For style 6, 6G and 7, procure strain relief backshell separately. See Table 02-4-2.
5. When styles 9 and 9G, are used in space shuttle missions, insert arrangement 8-2 with socket contacts and E, F, G & H polarization shall be reserved for connection to NSI-1 (NASA standard initiator Type 1) pyrotechnic firing circuits.
6. Crimp type ferrule is required to terminate cable shield to the backshell, and must be provided separately. Order Thomas & Betts P/N GSC 17512NP or equivalent.
7. Insert arrangement designation consists of shell size and arrangement number. For 40M38298 connectors, only size 20 contacts are available.

MSFC 40M39569 Circular Connectors, (Notes 1 through 3) (Page 1 of 2)
Low Outgassing, Bayonet Coupled, -150°C to +200°C

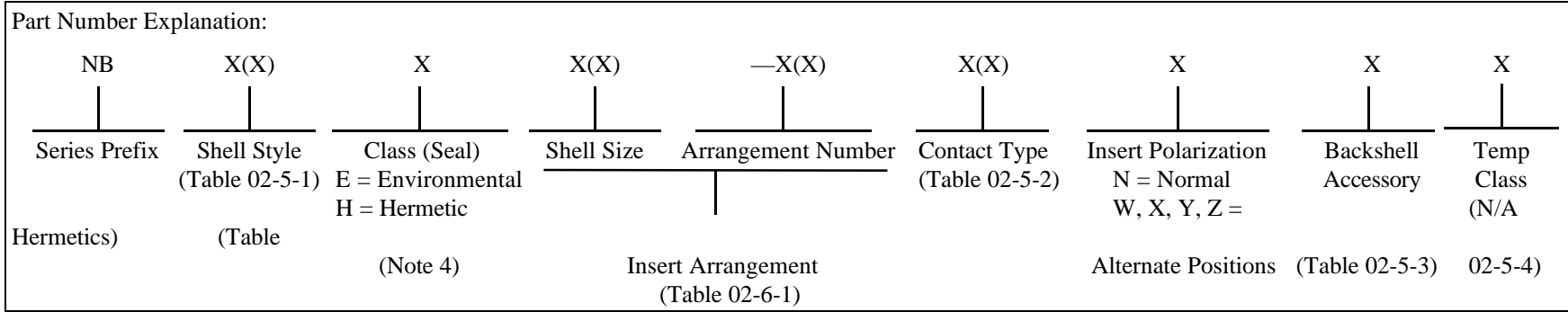

Table 02-5-1 Connector Styles

0 = Receptacle, flange mount Narrow	6 = Plug, cable mount
3 = Receptacle, Solder Mount, Hermetic	6G = Plug, cable mount, with RFI grounding fingers
4 = Receptacle Flange Mount, Wide flange	7 = Receptacle, jam nut mount
5 = Bulkhead feed thru, hermetic, jam nut mount	8 = Receptacle, jam nut mount, extended pin

Table 02-5-2 Contacts

P = Pins
S = Sockets
CP = Coaxial Pin
CS = Coaxial Socket
PS = Pin-Socket feedthrough (Style 5 only)

Table 02-5-3 Backshells

C = Straight, compression ring
S = Straight, with cable clamp
R = Right Angle, cable clamp
T = No backshell

Table 02-5-4 Temperature

Blank = Gen'l Purpose (-100°C to +200°C)
2 = Vacuum thermal cycled (-150°C to +200°C)
3 = Atmosphere Thermal cycled (-150°C to +200°C)

See notes on page 02-6.

MSFC 40M39569 Circular Connectors, (Notes 1 and 2) (Page 2 of 2)
Low Outgassing, Bayonet Coupled, -150°C to +200°C

Table 02-6-1 Insert Arrangements for 40M39569 Connectors (Note 3)

Insert Arrangement	No. of Contacts (By Contact Size)				Insert Arrangement	No. of Contacts (By Contact Size)			
	20	16	12	Coax		20	16	12	Coax
8-98	3				18-8			8	
10-6	6				18-11		11		
12-3		3			18-30	29	1		
12-8	8				18-32	32			
12-10	10				20-16		16		
14-4			4		20-39	37	2		
14-5		5			20-41	41			
14-12	8	4			22-12			12	
14-15	14	1			22-21		21		
14-18	18				22-41	27	14		
14-19	19				22-55	55			
16-8		8			24-19			19	
16-23	22	1			24-31		31		
16-26	26				24-61	61			
					24-100				8

Notes:

1. Connectors may be used in Grade 1 or 2 applications.
2. Connectors are supplied with contacts.
3. Insert arrangement designation consists of shell size and arrangement number. For 40M39569 connectors, insert arrangements with a variety of contact sizes are available.
4. Temperature range for hermetically sealed connectors is -100°C to +150°C.

MIL-C-38999 Series I & II, (Notes 1 through 4) (Page 1 of 2)
Circular Connectors, Bayonet Coupled, -65°C to +200°C

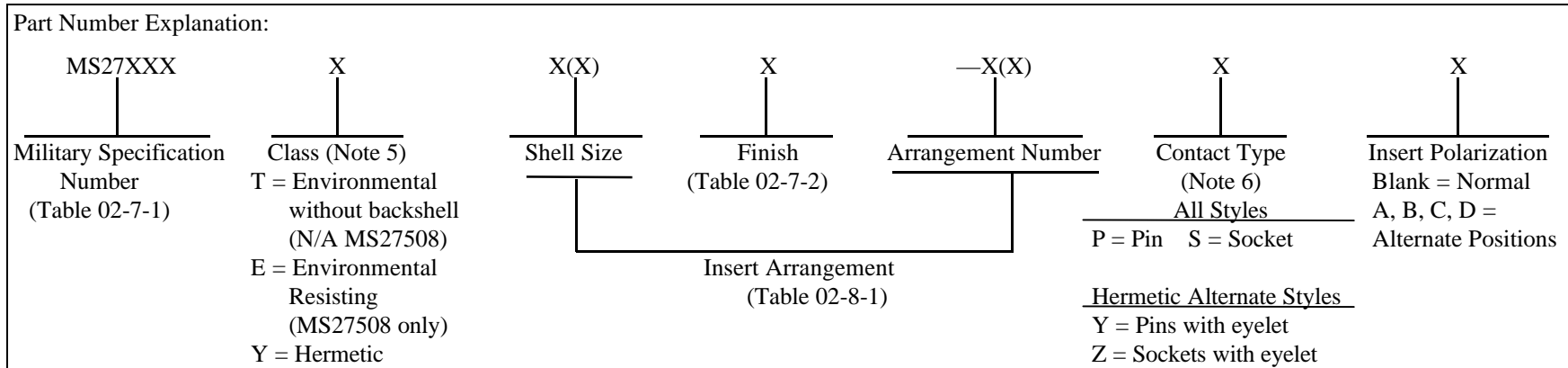

Table 02-7-1 Connector Styles

Series I Scoop-Proof	Series II Low Silhouette	Style Description
MS27466	MS27472	Receptacle, Wall Mount Flange
MS27468	MS27474	Receptacle, Jam Nut Mount
MS27656	MS27497	Receptacle, Wall Mount, Back Panel Mount
—	MS27508	Receptacle, Box Mount, Back Panel Mount
—	MS27473	Plug
MS27467	MS27484	Plug with RFI Grounding Fingers
MS27470	MS27477	Receptacle, Jam Nut Mount, Hermetic
MS27471	MS27478	Receptacle, Solder Mount, Hermetic

Table 02-7-2 GSFC Preferred Finish

<u>CLASS T, E</u> F = Electroless Nickel
<u>CLASS Y</u> D = Tin (150°C) E = Passivated Stainless Steel

Notes: (Continued on page 02-8)

1. Connectors require additional processing for contamination control due to outgassing. Special low outgassing Series I and II connectors may be procured to GSFC Specification S-311-P-768.
2. Connectors may be used in Grade 1 and 2 applications.
3. Accessories such as strain relief backshells must be provided separately. Refer to Page 02-40 for a selection list.
4. Series I and Series II connectors are not intermateable.
5. Specify Class T for all type except hermetic and MS27508 connectors. Specify Class E for MS27508 only. Class E is not preferred for all other specifications and is inactive for new design.
6. Connectors are supplied with contacts. Refer to Page 02-37 for a selection of replacement contact part numbers.

MIL-C-38999 Series I & II, (Page 2 of 2)
Circular Connectors, Bayonet Coupled, -65°C to +200°C

Table 02-8-1 Insert Arrangements for MIL-C-38999 Series I & II Connectors (Notes 7, 8)

Insert Arrangement		No. of Contacts (By Contact Size)			
Series I	Series II	22D	20	16	12
9-35	8-35	6			
9-98	8-98		3		
11-4	N/A	13	4		
11-5	10-5		5		
11-35	10-35				
11-98	10-98		6		
11-99	10-99		7		
N/A	12-3				3
13-4	12-4	22		4	
13-8	12-8		8		
13-35	12-35				
13-98	12-98		10		
15-5	14-5	37		5	
15-15	14-15		14	1	
15-18	14-18		18		
15-19	N/A		19		
15-35	14-35				
15-97	14-97		8	4	
17-6	16-6	55			6
17-8	16-8			8	
17-26	16-26			26	
17-35	16-35				
17-99	16-99			21	2

Insert Arrangement		No. of Contacts (By Contact Size)			
Series I	Series II	22D	20	16	12
9-11	18-11	66		11	
N/A	18-28		26	2	
N/A	18-30		29	1	
19-32	18-32			32	
19-35	18-35				
N/A	18-96				
21-11	N/A	79			11
21-16	20-16				16
21-35	20-35				
21-39	20-39			37	2
21-41	20-41			41	
23-21	22-21	100		21	
N/A	22-32			32	
23-35	22-35				
23-53	N/A			53	
23-55	22-55			55	
25-4	24-4	128		8	
25-19	24-19				
25-24	24-24				12
25-29	24-29				29
25-35	24-35				
25-43	N/A			23	20
25-61	24-61			61	

Notes:

7. Consult latest MIL-C-38999 Qualified Products List for availability. Other insert arrangements are available but are not preferred due to limited availability.
8. Insert arrangement designation consists of shell size and arrangement number. Inserts with a variety of contact sizes are available.

MIL-C-38999 Series III & IV, (Notes 1 through 5) (Page 1 of 2)
Circular Connectors, -65°C to +200°C

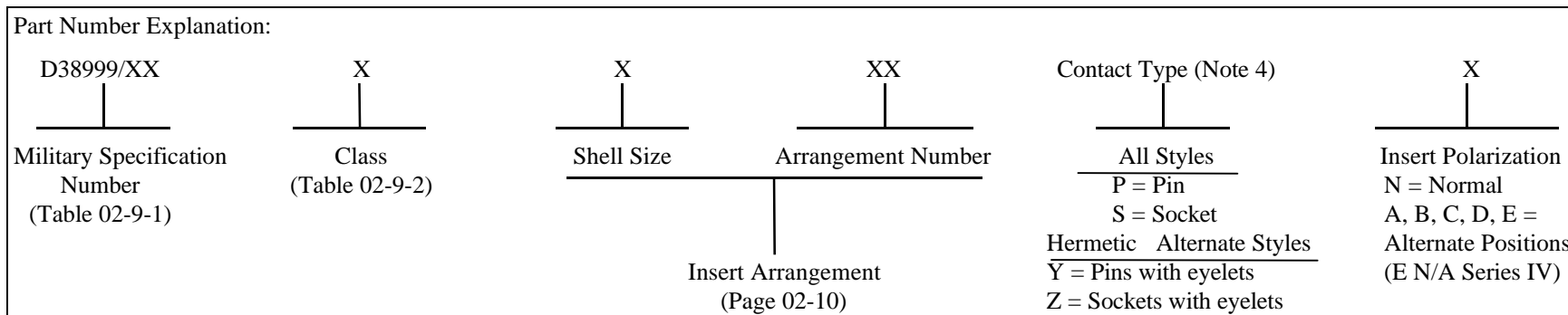

Table 02-9-1 Connector Detail Specifications

Series III Scoop-Proof 3 Way Self Locking Threaded Coupling	Series IV Scoop Proof Breech Coupling	Style Description
D38999/20	D38999/40	Receptacle, Wall Mount Flange
D38999/24	D38999/44	Receptacle, Jam Nut Mount
—	D38999/42	Receptacle, Box Mount
—	D38999/47	Plug
D38999/26	D38999/46	Plug, EMI Grounding Fingers
D38999/21	D38999/41	Receptacle, Box Mount, Hermetic
D38999/23	D38999/43	Receptacle, Jam Nut Mount, Hermetic
D38999/25	D38999/45	Receptacle, Solder Mount, Hermetic
D38999/27	D38999/48	Receptacle, Weld Mount, Hermetic

Table 02-9-2

<u>CLASS DESCRIPTION</u>
F = Environment Resisting, Conductive Electroless Nickel Coating
N = Hermetically Sealed, Corrosion Resistant Steel, Conductive Electro-Deposited Nickel Finish
Y = Hermetically Sealed, Corrosion Resistant Steel, Conductive Passivated Finish

Notes: (Continued on page 02-10)

1. Connectors require additional processing for contamination control due to outgassing. Special low outgassing Series III connectors may be procured to GSFC Specification S-311-P-768.
2. Connectors may be used in Grade 1 and 2 applications.
3. Accessories such as strain relief backshells must be provided separately. Refer to Page 02-40 for a selection list.
4. Connectors are supplied with contacts. Refer to Page 02-37 for a selection of replacement contact part numbers.
5. Series III and Series IV connectors are not intermateable, nor are they intermateable with Series I or II.

MIL-C-38999 Series III & IV, (Page 2 of 2)
Circular Connectors, -65°C to +200°C

Table 02-10-1 Insert Arrangements for MIL-C-38999 Series III & IV Connectors (Notes 6, 7)

Insert Arrangement			No. of Contacts (By Contact Size)			
Number	Series III	Series IV	22D	20	16	12
A35	X	N/A	6			
A98	X	N/A		3		
B4	X	N/A		4		
B5	X	X		5		
B35	X	X	13			
B98	X	N/A		6		
B99	X	X		7		
C4	X	X			4	
C8	X	N/A		8		
C35	X	X	22			
C98	X	X		10		
D5	X	X			5	
D15	X	N/A		14	1	
D18	X	X		18		
D19	X	X		19		
D35	X	X	37			
D97	X	X		8	4	
E6	X	X				6
E8	X	X			8	
E26	X	X		26		
E35	X	X	55			
E99	X	X		21	2	

Insert Arrangement			No. of Contacts (By Contact Size)			
Number	Series III	Series IV	22D	20	16	12
F11	X	X			11	
F32	X	X		32		
F35	X	X	66			
G11	X	X				11
G16	X	X			16	
G35	X	X	79			
G39	X	N/A		37	2	
G41	X	X		41		
H21	X	X			21	
H35	X	X	100			
H53	X	N/A		53		
H55	X	X		55		
J4	X	X		48	8	
J19	X	X				19
J24	X	X			12	12
J29	X	X			29	
J35	X	X	128			
J43	X	N/A		23	20	
J61	X	X		61		

Notes:

6. Insert arrangement designation consists of shell size designator and arrangement number. Insert arrangements with a variety of contact sizes are available. Insert arrangement shell size designations are as follows: A=Shell size 9, B=11, C=13, D=15, E=17, F=19, G=21, H=23, J=25
7. Consult latest MIL-C-38999 Qualified Products List for availability. Other insert arrangements are available but are not preferred due to limited QPL availability.

MIL-C-26482 Series 2, Circular Connectors, (Notes 1 through 4) (Page 1 of 2)
Bayonet Coupled, -55°C to +200°C

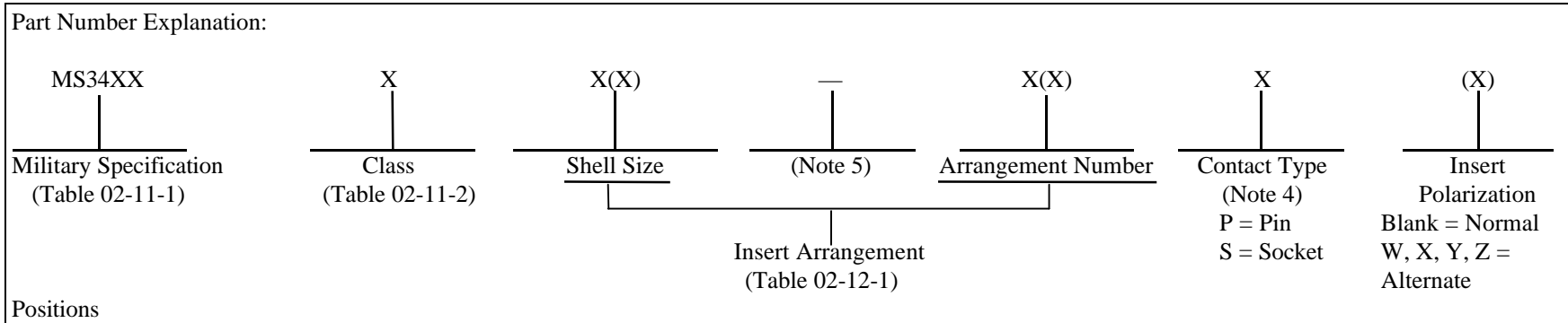

Table 02-11-1 Configuration Styles

MS3470 = Receptacle, Flange Mount, Narrow Flange
MS3472 = Receptacle, Flange Mount, Wide Flange
MS3474 = Receptacle, Jam Nut Mount
MS3475 = Plug, Cable Mount, RFI Shielded
MS3476 = Plug, Cable Mount
MS3449 = Receptacle, Hermetic

Table 02-11-2 Class

L = Fluid Resistant, Electroless Nickel Finish (Preferred)
A = Grommet Seal, Non-Conductive Anodic Coating (Not for use with MS3475 Plug)
H = Hermetic Seal, Steel Shell, Tin over Nickel Finish or stainless steel shell, passivated

Table 02-11-3 MS3449 Termination Type

Code	Description	Shell Mat'l
A	Solder cup	Stainless Steel
B	Eyelet	Stainless Steel
C	Soldercup	Cold Rolled Steel

Notes: (Continued on page 02-12)

1. Connectors require additional processing for contamination control due to outgassing. Special low outgassing connectors may be procured to GSFC Specification S-311-P-768.
2. Connectors are preferred for Grade 2 applications where outgassing is not a concern. Consult Appendix A for additional testing required in Grade 1.
3. Accessories such as strain relief backshells must be provided separately. Refer to Page 02-40 for a selection list.
4. Connectors are supplied with contacts. Refer to Page 02-37 for a selection of replacement contact part numbers.
5. For MS3449 Hermetic Connectors, replace the “—” with the code designation from Table 02-11-3 to specify solder contact terminations types. Only pin type contacts are available with hermetic connectors.

MIL-C-26482 Series 2, Circular Connectors, (Page 2 of 2)
Bayonet Coupled, -55°C to +200°C

Table 02-12-1 Insert Arrangements for MIL-C-26482 Connectors (Notes 6, 7)

Insert Arrangement	No. of Contacts (By Contact Size)			Insert Arrangement	No. of Contacts (By Contact Size)		
	20	16	12		20	16	12
8-33	3			18-8			8
8-98	3			18-11		11	
10-6	6			18-30	29	1	
12-3		3		18-32	32		
12-8	8			20-16		16	
12-10	10			20-24	24		
14-4			4	20-39	37	2	
14-5		5		20-41	41		
14-9	5		4	22-12			12
14-12	8	4		22-21		21	
14-15	14	1		22-32	32		
14-18	18			22-41	27	14	
14-19	19			22-55	55		
16-8		8		22-95	26		6
16-14	8		6	24-19			19
16-23	22	1		24-31		31	
				24-61	61		

Notes:

6. Insert arrangement designation consists of shell size designator and arrangement number. Insert arrangements with a variety of contact sizes are available.
7. Consult latest MIL-C-26482 qualified products list for availability. Other insert arrangements are available but are not preferred due to limited availability.

**MIL-C-5015, Circular Connectors, (Notes 1 through 4)
Threaded Coupling, Rear Release Contacts, -55°C to +200°C**

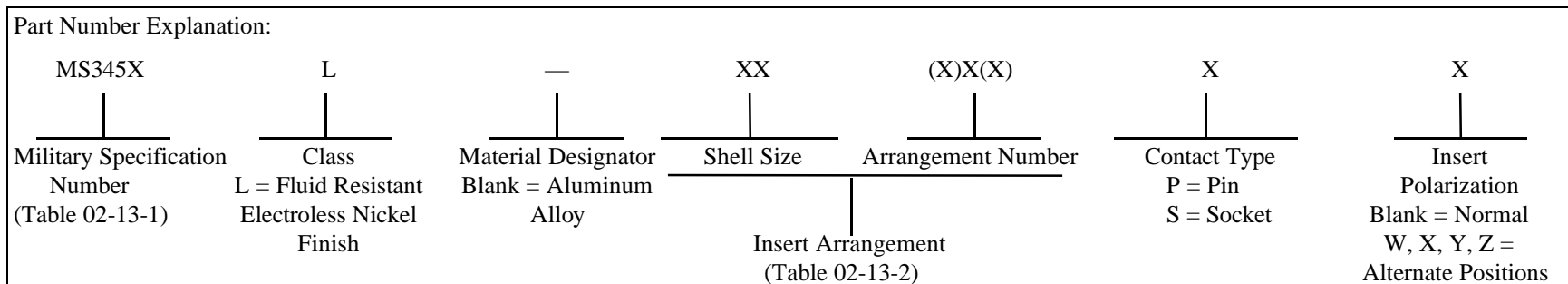

Table 02-13-1 Connector Styles (Note 5)

MS3450 = Receptacle, Wall Mount	MS3456 = Plug, Cable Mount
MS3452 = Receptacle, Box Mount (No Provision for backshell Attachment)	MS3459 = Plug, Cable Mount, Self Locking Coupling Ring
MS3454 = Receptacle, Jam Nut Mount	

**Table 02-13-2 Preferred
MIL-C-5015 Insert Arrangements (Note 6)**

Insert Arrangement	Number of Contacts (By Contact Size)				
	16	12	8	4	0
14S2 (Short Shell)	4				
14S5 (Short Shell)	5				
14S7 (Short Shell)	3				
16S1 (Short Shell)	7				
18-1	10				
20-4		4			
20-27	14				
22-2			3		
22-14	19				
22-22			4		
24-10			7		
24-28	24				
28-21	37				
32-17				4	
36-5					4
36-10	48				
36-52	52				

Notes:

1. Connectors require additional processing for contamination control due to outgassing.
2. Connectors are preferred for Grade 2. Consult Appendix A for additional testing required in Grade 1 applications.
3. Connectors are supplied with contacts. Refer to Page 02-37 for a selection of replacement contact part numbers.
4. Accessories such as strain relief backshells must be provided separately. Refer to Page 02-40 for a selection list.
5. These MIL-C-5015 connectors supersede MIL-C-83723 Series II connectors per MIL-C-83723/19 through MIL-C-83723/24. MS345X connectors are fully intermateable and intermountable with MIL-C-83723 Series II connectors.
6. Insert arrangement designation consists of shell size designator and arrangement number. Insert arrangements with a variety of contacts sizes are available. Only GSFC preferred insert arrangements are shown. Other insert arrangements are available. Consult latest MIL-C-5015 Qualified Products List for availability.

GSFC S-311-P-4 D-Subminiature Connectors, Crimp Removable Contacts, -55°C to +125°C (Notes 1 through 4)

Part Number Explanation:					
311P4	0X	-X	X	-X	-XX
GSFC Procurement Specification Prefix	Detail Specification 09 = Standard Density (Size 20 contacts, Page 02-17) 07 = High Density (Size 22D contacts) Page 02-18) 05 = Combination Inserts (Note 5)	Insert Arrangement	Contact Type S = Sockets P = Pins	Residual Magnetism Level B = 200 Gamma	Mounting Hole Size 12 = .120 in 15 = .150 in

Notes:

1. a. 311P409 connectors are described in detail on page 02-17 and are compared with MIL-C-24308 connectors with size 20 crimp contacts.
- b. 311P407 connectors are described in detail on page 02-18 and are compared with MIL-C-24308 connectors with size 22D crimp contacts.
- c. 311P405 connectors and insert arrangements are described in detail on page 02-20.
2. Connectors may be used in Grade 1 and Grade 2 applications.
3. Hardware such as screwlocks, jackscrews, and jackposts are required to properly secure mated connector pairs, and must be provided separately. Non-magnetic hardware is recommended to maintain controlled residual magnetism.
4. Connectors satisfy GSFC outgassing requirements of 1 percent Total Mass Loss (TML) and 0.1 percent Collected Volatile Condensable Material (CVCM).
5. Connectors are offered with combination type inserts which offer a variety of insert arrangements for use with coaxial and high voltage contacts with No. 20 power contacts. Insert arrangements and contact part numbers are given on page 02-20.

GSFC S-311-P-10 D-Subminiature Connectors, Solder Contacts, -55°C to +125°C (Notes 1 through 4)

Part Number Explanation:					
311P10	(B)	-X	X	-X	-XX
-----	-----	-----	-----	-----	-----
GSFC Procurement Specification Prefix	Socket Contact Designator (Not applicable to pin contacts) No digit = contact springs B = split finger sleeved (first choice)	Insert Arrangement Page 02-19 for Standard Density. Page 02-20 for combination insert arrangements.	Contact Type P = Pins S = Sockets	Residual Magnetism Level B = 200 Gamma C = 20 Gamma	Mounting Hole Size 12 = .120 inch 15 = .150 inch

Notes:

1. 311P10 connectors with insert arrangements 1 through 5 are described in detail on page 02-19, and are compared with equivalent MIL-C-24308 connectors with size 20 solder contacts. 311P10 connectors with insert arrangements 6 through 25 are shown in detail on page 02-20, and are compared to equivalent 311P405 combination insert connectors.
2. Connectors may be used in Grade 1 or Grade 2 applications.
3. Hardware such as screwlocks, jackscrews, and jackposts are required to properly secure mated connector pairs, and must be provided separately. Non-magnetic hardware is recommended to maintain controlled residual magnetism.
4. Connectors satisfy GSFC outgassing requirements of 1 percent Total Mass Loss (TML) and 0.1 percent Collected Volatile Condensable Material (CVCM).

MIL-C-24308 D-Subminiature Connectors, -55°C to +125°C (Notes 1 through 5)

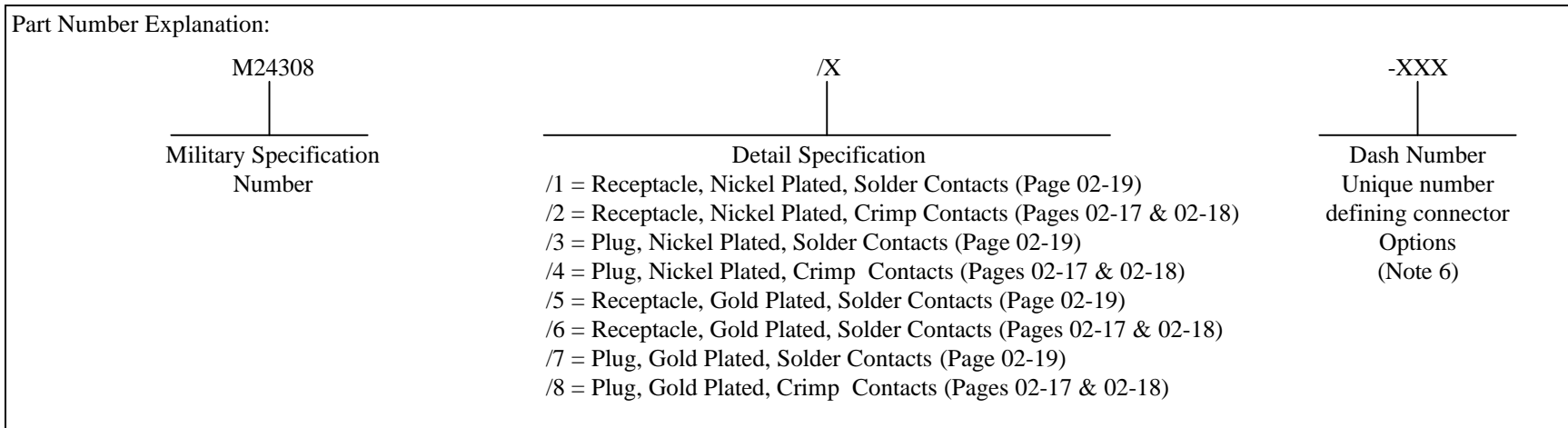

Notes:

1. Connectors are described in detail on page 02-17 (size 20 crimp contacts), 02-18 (size 22D crimp contacts), and 02-19 (size 20 solder contacts), and are referenced to corresponding GSFC S-311 specification.
2. Consult Appendix A for additional testing required for Grade 1 applications.
3. MIL-C-24308 connectors are supplied with 0.120 inch mounting holes or 0.086 float mount bushings.
4. Hardware such as screwlocks, jackscrews, and jackposts are required to properly secure mated connector pairs, and must be provided separately.
5. Connectors satisfy GSFC outgassing requirements of 1 percent Total Mass Loss (TML) and 0.1 percent Collected Condensable Volatile Material (CCVM).
6. MIL-C-24308 connectors are also available without contacts, with float mount bushings, or as kits. Many of these part numbers are not preferred because they are cadmium plated. The preferred part numbers for the various contacts are listed on page 02-17, 02-18 and 02-19.

**GSFC S-311-P-4/09 and MIL-C-24308 D-Subminiature Connectors
Standard Density Size 20 Crimp Contacts (Note 1)**

	Description	General Purpose	Non-Magnetic	Non-Magnetic Controlled Low Residual Magnetism
	Shell Finish	Nickel	Gold	Gold
	Grade	2	2	1 and 2
	Specification	MIL-C-24308/2	MIL-C-24308/6	GSFC S-311-P-4/09
Receptacle, Socket Contacts	Number of Contacts (All Size 20)	Part Number (Note 2)	Part Number (Note 2)	Part Number (Note 3)
	9	M24308/2-516	M24308/6-502	311P409-1S-B-12
	15	M24308/2-517	M24308/6-503	311P409-2S-B-12
	25	M24308/2-518	M24308/6-504	311P409-3S-B-12
	37	M24308/2-519	M24308/6-505	311P409-4S-B-12
	50	M24308/2-520	M24308/6-506	311P409-5S-B-12
	Specification	MIL-C-24308/4	MIL-C-24308/8	GSFC S-311-P-4/09
	Number of Contacts (All Size 20)	Part Number (Note 2)	Part Number (Note 2)	Part Number (Note 3)
	9	M24308/4-335	M24308/8-335	311P409-1P-B-12
	15	M24308/4-336	M24308/8-336	311P409-2P-B-12
Plug, Pin Contacts	25	M24308/4-337	M24308/8-337	311P409-3P-B-12
	37	M24308/4-338	M24308/8-338	311P409-4P-B-12
	50	M24308/4-339	M24308/8-339	311P409-5P-B-12

Notes:

- The following MIL-C-24308 numbers are also preferred parts for Grade 2 applications:
M24308/2 -521 to -525 (kit); -560 to -564 (less contacts); -585 to -589, -596 to -600, -607 to -611 (.086 DIA float mount bushings in lieu of .120 DIA mounting holes).
M24308/4 -340 to -344 (Kit), -357 to -361 (less contacts), -401 to -405, -412 to -416, -423 to -427 (float mount).
M24308/6 -507 to -511 (Kit), -540 to -544 (less contacts), -551 to -555, -562 to -566, -573 to -577 (float mount).
M24308/8 -340 to -344 (Kit), -357 to -361 (less contacts), -401 to -405, -412 to -416, -423 to -427 (float mount).
- MIL-C-24308 Connectors are supplied with contacts. Replacement contact part numbers are M39029/63-368 for sockets and M24308/64-367 for pins.
- GSFC connectors are supplied without contacts. Procure P/N G10S1 for socket contacts and G10SP1 for pin contacts per GSFC specification S-311-P-4/10.

**GSFC S-311-P-4/07 and MIL-C-24308 D-Subminiature Connectors
High Density Size 22D Crimp Contacts (Note 1)**

	Description	General Purpose	Non-Magnetic	Non-Magnetic Controlled Low Residual Magnetism
	Shell Finish	Nickel	Gold	Gold
	Grade	2	2	1 and 2
	Specification	MIL-C-24308/2	MIL-C-24308/6	GSFC S-311-P-4/07
Receptacle, Socket Contacts	Number of Contacts (All Size 22D)	Part Number (Note 2)	Part Number (Note 2)	Part Number (Note 3)
	15	M24308/2-526	M24308/6-512	311P407-1S-B-12
	26	M24308/2-527	M24308/6-513	311P407-2S-B-12
	44	M24308/2-528	M24308/6-514	311P407-3S-B-12
	62	M24308/2-529	M24308/6-515	311P407-4S-B-12
	78	M24308/2-530	M24308/6-516	311P407-5S-B-12
	104	M24308/2-531	M24308/6-517	311P407-6S-B-12
Plug, Pin Contacts	Specification	MIL-C-24308/4	MIL-C-24308/8	GSFC S-311-P-4/07
	Number of Contacts (All Size 22D)	Part Number (Note 2)	Part Number (Note 2)	Part Number (Note 3)
	15	M24308/4-345	M24308/8-345	311P407-1P-B-12
	26	M24308/4-346	M24308/8-346	311P407-2P-B-12
	44	M24308/4-347	M24308/8-347	311P407-3P-B-12
	62	M24308/4-348	M24308/8-348	311P407-4P-B-12
	78	M24308/4-349	M24308/8-349	311P407-5P-B-12
	104	M24308/4-350	M24308/8-350	311P407-6P-B-12

Notes:

- The following MIL-C-24308 numbers are also preferred parts for Grade 2 applications:
M24308/2 -532 to -537 (Kit); -565 to -570 (less contacts); -590 to -595, -601 to -606, -612 to -617 (.086 DIA float mount bushings in lieu of .120 DIA mounting holes).
M24308/4 -351 to -356 (Kit), -362 to -367 (less contacts), -406 to -411, -417 to -422, -428 to -433 (float mount).
M24308/6 -518 to -523 (Kit), -545 to -550 (less contacts), -556 to -561, -567 to -572, -578 to -583 (float mount).
M24308/8 -351 to -356 (Kit), -362 to -367 (less contacts), -406 to -411, 417 to -422, -428 to -433 (float mount).
- MIL-C-24308 Connectors are supplied with contacts. Replacement contact part numbers are M39029/57-354 for sockets and M24308/58-360 for pins.
- GSFC connectors are supplied without contacts. Procure P/N G08S1 for socket contacts and G08P1 for pin contacts per GSFC specification S-311-P-4/08.

GSFC S-311-P-10 and MIL-C-24308 D-Subminiature Connectors, Standard Density Size 20 Solder Contacts (Note 1)

	Description	General Purpose	Non-Magnetic	Non-Magnetic Controlled Low Residual Magnetism
	Shell Finish	Nickel	Gold	Gold
	Grade	2	2	1 and 2
	Specification	MIL-C-24308/1	MIL-C-24308/5	GSFC S-311-P-10
Receptacle, Socket Contacts	Number of Contacts (All Size 20)	Part Number	Part Number	Part Number
	9	M24308/1-34	M24308/5-34	311P10-1S-B-12
	15	M24308/1-35	M24308/5-35	311P10-2S-B-12
	25	M24308/1-36	M24308/5-36	311P10-3S-B-12
	37	M24308/1-37	M24308/5-37	311P10-4S-B-12
	50	M24308/1-38	M24308/5-38	311P10-5S-B-12
Plug, Pin Contacts	Specification	MIL-C-24308/3	MIL-C-24308/7	GSFC S-311-P-10
	Number of Contacts (All Size 20)	Part Number	Part Number	Part Number
	9	M24308/3-23	M24308/7-23	311P10-1P-B-12
	15	M24308/3-24	M24308/7-24	311P10-2P-B-12
	25	M24308/3-25	M24308/7-25	311P10-3P-B-12
	37	M24308/3-26	M24308/7-26	311P10-4P-B-12
50	M24308/3-27	M24308/7-27	311P10-5P-B-12	

Notes:

- The following part number which offer .086 diameter float mount bushings in lieu of .120 diameter mounting holes are also preferred connectors for Grade 2 applications: M24308/1 -56 through -60; M24308/3-39 through -43; M24308/5-56 through -60; M24308/7-34 through -38.

**GSFC S-311-P-4/05 and S-311-P-10 D-Subminiature Connectors, (Notes 1 and 2)
Combination Power, Coaxial and High Voltage Contacts**

Table 02-20-1 Insert Arrangements

Insert Arrangement		Number of Contacts (Note 4)	
GSFC Number (Note 3)	Generic	Size 20 Standard Power	Coaxial and/or High Voltage
-6	5W1	4	1
-7	3W3	0	3
-8	7W2	5	2
-9	11W1	10	1
-10	5W5	0	5
-11	9W4	5	4
-12	13W3	10	3
-13	17W2	15	2
-14	21W1	20	1
-15	8W8	0	8
-16	13W6	7	6
-17	17W5	12	5
-18	21WA4	17	4
-19 (Cancelled)	N/A	17	4
-20	25W3	22	3
-21	N/A	25	2
-22	24W7	17	7
-23	36W4	32	4
-24	43W2	41	2
-25	N/A	46	1

Table 02-20-2 Coaxial and High Voltage Contact Part Numbers

Part Number	Description	Standard Cable Part No.
GCP1 GCP2	Coaxial Plug	M17/93-RG-178 M17/94-RG-179, M17/113-RG-316
GCP3		M17/95-RG-180
GCRP1 GCRP2	Coaxial Right Angle Plug	M17/93-RG-178 M17/94-RG-179, M17/113-RG-316
GRRP3		M17/95-RG-180
GCS1 GCS2	Coaxial Receptacle	M17/93-RG-178 M17/94-RG-179, M17/113-RG-316
GCS3		M17/95-RG-180
GCRS1 GCRS2	Coaxial Right Angle Receptacle	M17/93-RG-178 M17/94-RG-179, M17/113-RG-316
GCRS3		M17/95-RG-180
GHP6 GHS6 GHRP6 GHRS6	High Voltage Plug High Voltage Receptacle High Voltage Right Angle Plug High Voltage Right Angle Receptacle	20 AWG through 26 AWG conductor

Notes:

1. Coaxial contacts should be used for signals of 1 Mhz frequency or less. Use MIL-C-39012 connectors for higher frequencies.
2. Some suppliers use a nylon insulator material in their high voltage contacts. The nylon insulator may not meet program outgassing limits.
3. Connectors utilizing GSFC insert arrangements 1 through 5 are for standard density inserts with size 20 solder contacts, and are listed on page 02-19.
4. Coaxial, high voltage and Crimp standard power contacts must be supplied separately. Refer to Table 02-20-02. Coaxial and high voltage contact part numbers referenced in Table 02-20-2 are procured per GSFC specification S-311-P-4/06. For Crimp type standard power contacts, procure P/N G10S1 for socket contacts and G10P1 for pin contacts per GSFC specification S-311-P-4/10.

MIL-C-55302 Printed Circuit Connectors, -65°C to +125°C (Notes 1 through 3) (Page 1 of 3)

Part Number Explanation:

M55302/ 	XX(X) 	— 	X 	XX(X) 	X 	[X(X)]
Military Specification Number	Detail Specification	Socket Contact Type (Omit for Pin Contacts) - = Normal insertion force (N/A/190/192) L = Low Insertion Force	Terminal Type	Number of Contacts	Type of Mounting Hardware	Optional Polarization Code for Hardware Style "Y" (Note 4)

Part Number	Type Description	Terminal Type	No. of Contacts	Mounting Hardware Options (Table 2-22-4)
.100 Inch Spacing Between Contacts				
M55302/55XXXXX	Plug, Socket Contacts, Straight	Table 2-22-2	10, 14, 20 34, 26, 30, 36, 40, 44 50, 54, 56 60, 66, 70 90, 100, 120 160	L, M, S, H
M55302/56-XXXX	Receptacle, Pin Contacts	Table 2-22-2		Jackset
M55302/57-XXXX	Plug, Pin Contacts, Right Angle	Table 2-22-1		X, Y, S, H
M55302/58XXXXX	Receptacle, Socket Contacts	Table 2-22-2		X, Y, F, S, H
M55302/61-XXXX	Plug, Pin contacts, Right Angle	Table 2-22-1		Jackset
M55302/62XXXXX	Receptacle, Socket Contacts	Table 2-22-2		L, M, S, H
M55302/63-XXXX	Plug, Pin Contacts, Straight	Table 2-22-2		L, M, S, F, H, X, Y
M55302/64XXXXX	Receptacle, Socket Contacts	Table 2-22-2		F, X, Y
M55302/65XXXXX	Receptacle, Socket Contacts	Crimp Removable (Note 5)		X, Y, F, S, H
M55302/66XXXXX	Receptacle, Socket Contacts	Crimp Removable (Note 5)		L, M, S, F, H
M55302/59-XXXX	Plug, Pin Contacts, Right Angle	Table 2-22-1		X, Y, F, S, H
M55302/60XXXXX	Receptacle, Socket Contacts	Table 2-22-2		
M55302/138XXXXX	Plug, Pin Contacts, Right Angle	Table 2-22-1		
M55302/139XXXXX	Receptacle, Socket Contacts	See Detail Spec.		
.075 Inch Spacing Between Contacts				
M55302/190LXXXX	Receptacle, Socket Contacts	Table 2-22-3	100	X, Y, F, S, N, L, M
M55302/191XXXXX	Plug, Pin Contacts, Right Angle	Table 2-22-1	122, 152	
M55302/192LXXXX	Receptacle, Socket Contacts	Table 2-22-3		
M55302/193XXXXX	Plug, Pin Contacts, Right Angle	Table 2-22-1		

See notes on page 02-23.

MIL-C-55302 Printed Circuit Connectors, -65°C to +125°C (Page 2 of 3)

Table 02-22-1 Contact Terminations Options for /57, /59, /61, /138, /191, /193

A = .109L Dip Terminal
 B = .140L Dip Terminal
 C = .172L Dip Terminal

Table 02-22-2 Contact Terminations Options for /55, /56, /58, /60, /62, /63, /64 (Note 6)

A = Solder Cup
 B = .140L Dip Terminal
 C = .172L Dip Terminal
 F = .100 Flex Circuit Terminal
 (Not applicable to /60, /63)

Table 02-22-3 Contact Terminations Options for /190 & /192 (Note 6)

A = Solder Cup
 B = .109L Dip Terminal
 C = .140L Dip Terminal
 D = .172L Dip Terminal
 E = .093 Flex Circuit Terminal

Table 02-22-4 Mounting Hardware Option

L = Long Slotted Turning Jackscrew (.700)
 M = Medium Slotted Turning Jackscrew (.500)
 S = Short Slotted Turning Jackscrew (.200) (Note 7)
 F = Fixed Jackscrew
 H = Short Hex Turning Jackscrew (.200) (Note 7)
 X = Full Round Guidepins
 Y = D Shaped Guidepins
 N = Turning Hex Jackset

Table 02-22-6 Connector Polarization with D Shaped Guide Pins and Sockets (Style

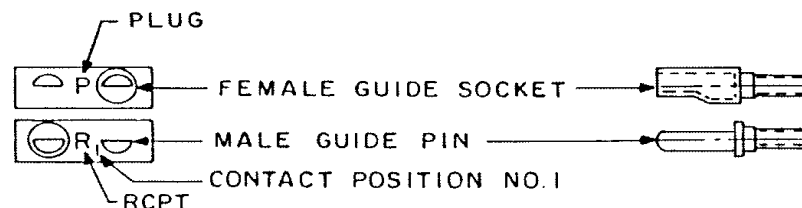
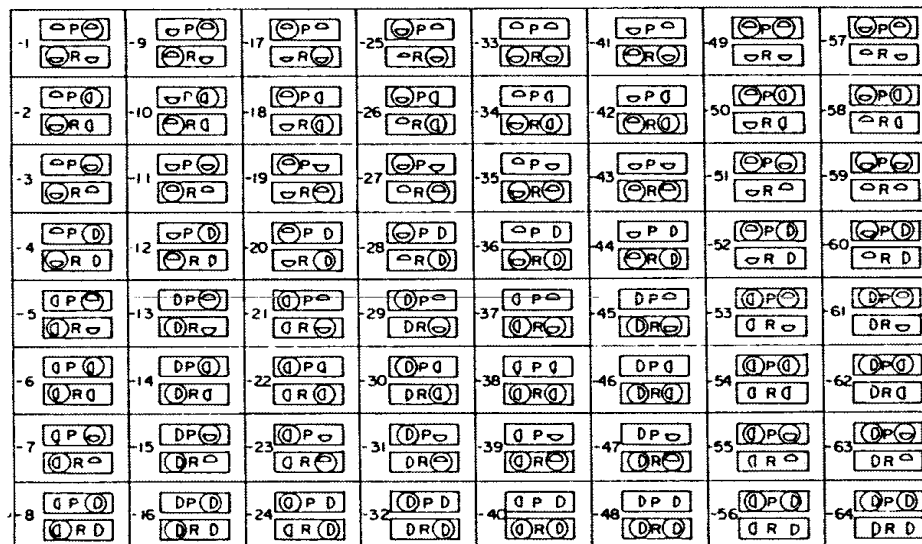

Table 02-22-5. Mating Information

Plug Detail Specification	Mating Receptacle Details Specification
/55	/56
/57, /61, /63	/58, /62, /64, /65, /66
/138	/139
/191	/190
/193	/192



See notes on page 02-23.

MIL-C-55302 Printed Circuit Connectors, -65°C to +125°C (Page 3 of 3)

Notes:

1. Connectors are preferred for use in Grade 2 applications. Consult Appendix A for additional testing required in Grade 1 applications.
2. Connectors are available with 0.075 and 0.100 inch spacing between contacts and satisfy GSFC outgassing requirements.
3. Hand soldering of these connectors is recommended. The use of wave soldering or infrared reflow equipment may overheat connectors, resulting in warpage or shifting of contact positions, and may cause high mating force or insufficient contact engagements.
4. For "D" shaped guidepin hardware only, style "Y", a polarization code may be added to the part number. This part number may appear on parts lists for assembly or other documents required for procurement, but is not marked on the part. Polarization code may be 1 through 64 in accordance with polarization Table 02-22-6 shown on page 02-22. Unless otherwise specified, all connectors are supplied in the -1 polarization position, and may be repolarized by using the M55302/57-01 spanner wrench procured separately per MIL-C-55302/57. Hardware shall be secured with low-outgassing adhesive.
5. MIL-C-55302/65 and /66 connectors contain crimp removable socket contacts which are supplied with the connectors. Replacement contact part numbers per MIL-C-55302/65 are M55302/65-01 for normal insertion force and M55302/65-02 for low insertion force.
6. Other contact termination styles are available. However, the letter designations for these options are not consistent between the detail specifications, and these termination styles are not offered in each detail specification. Consult detail specification and latest MIL-C-55302 QPL for availability.
7. For MIL-C-55302/57, /59 and /138 hardware options S and H, jackscrew length is .135 inches rather than .200 inches.

MIL-C-39012 Radio Frequency Connectors, (Notes 1 through 4) (Page 1 of 3)
SMA Series Coaxial, 50 Ohms

Part Number Explanation:

<p>M39012</p> <p>_____</p> <p>Military Specification Number</p>	<p>/XX</p> <p>_____</p> <p>Detail Specification</p>	<p>X</p> <p>_____</p> <p>- = Field Replaceable (Standard) B = Non-Field Replaceable Not Preferred (Note 5)</p>	<p>XXXX</p> <p>_____</p> <p>Dash Number -3XXX = Corrosion Resistant Steel Shell, Passivated Finish -4XXX = Beryllium Copper Shell, Gold Finish</p>
---	---	--	--

Part Numbers(s)		Configuration	Frequency, Max	Applicable Cable Type
Detail Specification	Dash Number			
M39012/55	-3006, -3025, -4006, -4025	Plug, Pin Contact, Cable Mount	12.4 GHz	M17/93-RG178
	-3007, -3026, -4007, -4026			M17/113-RG316
	-3009, -3028, -4009, -4028			M17/60-RG142
	-3010, -3029, -4010, -4029			M17/111-RG303
	-3030			M17/152-00001
	-3502, -4502			M17/128-RG400
M39012/56	-3006, -3025, -4006	Plug, Pin Contact, Right Angle, Cable Mount	12.4 GHz	M17/93-RG178
	-3007, -3026, -4007			M17/113-RG316
	-3009, -3028, -4009, -4028			M17/60-RG142
	-3010, -3029, -4010			M17/111-RG303
	-3030			M17/152-00001
	-3502, -4502			M17/128-RG400
M39012/57	-3006, -3025, -4006, -4025	Receptacle, Socket Contact, Cable Mount	12.4 GHz	M17/93-RG178
	-3007, -3026, -4007, -4026			M17/113-RG316
	-3009, -3028, -4009, -4028			M17/60-RG142
	-3010, -3029, -4010, -4029			M17/111-RG303
	-3030			M17/152-00001
	-3502, -4502			M17/128-RG400

See notes on page 02-26.

MIL-C-39012 Radio Frequency Connectors, (Notes 1 through 4) (Page 2 of 3)
SMA Series Coaxial, 50 Ohms

Part Numbers(s)		Configuration	Frequency, Max	Applicable Cable Type
Detail Specification	Dash Number			
M39012/58	-3006, -3025, -4006	Receptacle, Socket Contact, 4 Hole Flange Mount	12.4 GHz	M17/93-RG178
	-3007, -3026, -4007			M17/113-RG316
	-3009, -3028, -4009			M17/60-RG142
	-3010, -3029, -4010			M17/111-RG303
	-3030			M17/152-00001
	-3502, -4502			M17/128-RG400
M39012/59	-3006, -3025, -4006, -4025	Receptacle, Socket Contact, D-Hole Jam Nut Mount	12.4 GHz	M17/93-RG178
	-3007, -3026, -4007, -4026			M17/113-RG316
	-3009, -3028, -4009, -4028			M17/60-RG142
	-3010, -3029, -4010, -4029			M17/111-RG303
	-3030			M17/152-00001
	-3502, -4502			M17/128-RG400
M39012/60	-3001, -4001 (4 Hole) -3002 (2 Hole)	Receptacle, Socket Contact, Solder Cup, 4-Hole or 2- Hole Rear Flange Mount	Not Rated	All Flexible Cable Types
M39012/61	-3001, -4001 (Rear Mount) -3002, -4002 (Front Mount)	Receptacle, Socket Contact, Solder Cup, Rear or Front D-Hole Jam Nut Mount	Not Rated	All Flexible Cable Types
M39012/62	-3001, -4001 (Rear Mount) -3002, -4002 (Front Mount)	Receptacle, Socket Contact Hermetic Seal, Solder Lug Rear or Front D-Hole Jam Nut Mount	Not Rated	All Flexible Cable Types
M39012/79	-3009, -3007, -3207	Plug, Pin Contact, Cable Mount, Semirigid	18 GHz	M17/133-RG405
	-3010, -3008, -3208			M17/130-RG402
M39012/80	-3009, -3005, -3007, -3207	Plug, Pin Contact, Right Angle, Semirigid	18 GHz	M17/133-RG405
	-3010, -3006, -3008, -3208			M17/130-RG402
M39012/81	-3007, -3011, -3207	Receptacle, Socket Contact, Cable Mount, Semirigid	18 GHz	M17/133-RG405
	-3008, -3012, -3208			M17/130-RG402

See notes on page 02-26.

MIL-C-39012 Radio Frequency Connectors, (Notes 1 through 4) (Page 3 of 3)
SMA Series Coaxial, 50 Ohms

Part Numbers(s)		Configuration	Frequency, Max	Applicable Cable Type
Detail Specification	Dash Number			
M39012/82	-3007, -3011, -3207 (4 Hole) -3013 (2 Hole)	Receptacle, Socket Contact, 4 Hole or 2 Hole Flange Mount, Semirigid	18 GHz	M17/133-RG405
	-3008, -3012, -3028, (4 Hole) -3014 (2 Hole)			M17/130-RG402
M39012/83	-3009, -3007, -3011, -3207 -3010, -3008, -3012, -3208	Receptacle, Socket Contact, Rear D Hole Jam Nut Mount, Semirigid	18 GHz	M17/133-RG405 M17/130-RG402
M39012/93	-3001 (.155L Solder Terminal) -3002 (.125L Solder Terminal) -3003 (.093L Solder Terminal)	Receptacle, Socket Contact, PC Mount	500 MHz to 18 GHz	PC Board Mount
M39012/94	-3001 (.155L Solder Terminal) -3002 (.125L Solder Terminal) -3003 (.093L Solder Terminal)	Receptacle, Socket Contact, PC Mount, Right Angle	500 MHz to 18 GHz	PC Board Mount

Notes:

1. Connectors are preferred for use in Grade 2 applications. Consult Appendix A for additional testing required in Grade 1 applications.
2. Plug coupling nuts and cable nut mounted connectors may have silicone rubber O-Ring seals which are an outgassing concern. Connectors may require additional processing for outgassing control. This should include a bake of the connector or replacement of the silicone rubber O-Rings with fluorosilicone O-Rings which meet outgassing requirements.
3. Temperature range for flexible and semirigid connectors is -65°C to +165°C. Temperature range for PC mounted connectors is -65°C to +105°C.
4. The use of safety wire is recommended to secure mated connectors together.
5. B designated non-field replaceable connectors are not preferred. Most are inactive for new design.

MIL-C-83517 Radio Frequency Connectors (Notes 1 and 2) (Page 1 of 2)
Series SMA Transmission Line, 50 Ohms

Part Number Explanation:

<p>M83517</p> <p>_____</p> <p>Military Specification Number</p>	<p>/X</p> <p>_____</p> <p>Detail Specification</p>	<p>XXXXXX</p> <p>_____</p> <p>Dash Number</p> <p>-31XXX = Corrosion Resistant Steel Shell, Passivated Finish -32XXX = Corrosion Resistant Steel Shell, Gold Plated -33XXX = Corrosion Resistant Steel Shell, Gold Plated Body and Passivated Coupling Nut</p>
---	--	--

Part Number		Flange Mount Configuration		Solder Tab Configuration	
Detail Specification	Dash Number	Body Style	No. of Mounting Holes	Dimensions	Insulator Protrusion From Flange
M83517/1	-31001, 32001	Receptacle, Socket Contact	2	.005 x .020	Flush
	-31002, -32002			.005 x .050	
	31003, -32003		4	.005 x .020	
	31004, 32004			.005 x .050	
M83517/2	-31001, 32001	Plug, Pin Contact	2	.005 x .020	
	-31002, -32002			.005 x .050	
	31003, -32003		4	.005 x .020	
	31004, 32004			.005 x .050	
M83517/3	-31001, 32001	Receptacle, Socket Contact	2	.050 dia x .012 slot	
	-31002, -32002			.050 dia x .018 slot	
	-31003, -32003			.050 dia x .028 slot	
	-31007, -32007, -33007			.050 dia x .025 slot	.035 inches
	-31004, -32004		4	.050 dia x .012 slot	
	-31005, -32005, -33005			.050 dia x .018 slot	
	-31006, -32006, -33006			.050 dia x .025 slot	
				.050 dia x .025 slot	Flush

See notes on page 02-28.

MIL-C-83517 Radio Frequency Connectors (Notes 1 and 2) (Page 2 of 2)
Series SMA Transmission Line, 50 Ohms

Part Number		Flange Mount Configuration		Solder Tab Configuration	
Detail Specification	Dash Number	Body Style	No. of Mounting Holes	Dimensions	Insulator Protrusion From Flange (inches)
M83517/4	-31001, 32001	Receptacle, Socket Contact	2	.010 dia	.057
	-31002, -32002				.125
	-31003, -32003		4		.057
	-31004, -32004				.125
	-31005, -32005				.590
M83517/5	-31001, -32001, -33001	Plug, Pin Contact	4	.050	.330

Notes:

1. Connectors are preferred for use in Grade 2 applications. Consult Appendix A for additional testing required in Grade 1 applications.
2. Temperature range is -65°C to +105°C. Frequency range is 0 to 18GHz.

**MIL-C-83513 Microminiature Connectors, Pre-Terminated (Notes 1 through 5)
Crimp Contacts or Solder Contacts, -55°C to +125°C**

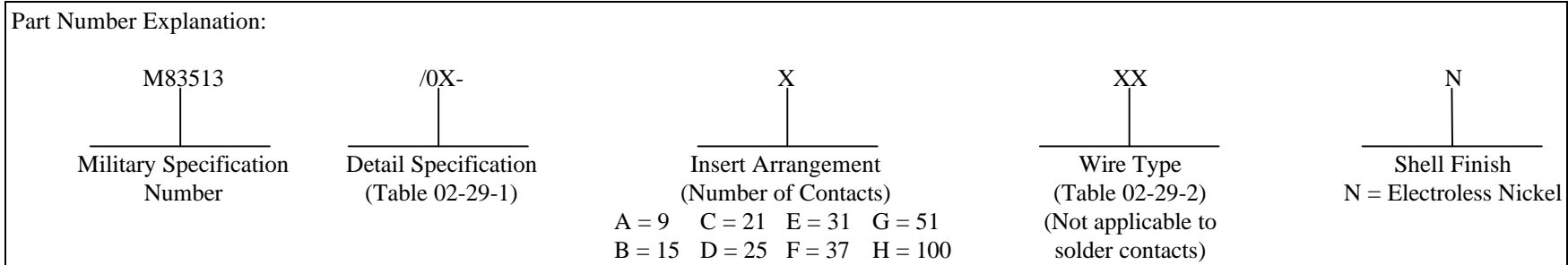

Table 02-29-1 Connector Styles

Part Number	Type	Termination	Shell
M83513/1-XN	Plug, Pin Contacts	Soldercup	Aluminum, Electroless
M83513/2-XN	Receptacle, Socket Contacts		
M83513/3-XXXN	Plug, Pin Contacts	Wire Pigtails	Nickel Plated
M83513/4-XXXN	Receptacle, Socket Contacts		
M83513/6-X	Plug, Pin Contacts	Soldercup	All Plastic
M83513/7-X	Receptacle, Socket Contacts		
M83513/8-XX	Plug, Pin Contacts	Wire Pigtails	
M83513/9-XXX	Receptacle, Socket Contacts		

Table 02-29-2 Wire Pigtail Termination Types

Code	Wire	Length
01	M22759/33-26-9 (Note 6)	18"L
02		36"L
03	M22759/33-26-X (Notes 6, 7)	18"L
04		36"L
05	QQ-W-343, Solid 25 AWG, Gold Plated	.5"L
06		1.0"L
07	QQ-W-343, Solid 25 AWG, Tin Plated	.5"L
08		1.0"L
09	M22759/33-26-9	18"L
10		36"L
11	M22759/33-26-X	18"L
12		36"L
13	M22759/11-26-9	72"L
14	M22759/11-26-X (Note 7)	
15	M22759/33-26-9	
16	M22759/33-26-X (Note 7)	

Notes:

1. Connectors are preferred for Grade 2 applications. Consult Appendix A for additional testing required in Grade 1 applications.
2. MIL-C-83513 metal shell receptacle connectors contain a thin silicone rubber interface seal which may represent an outgassing concern. The seal is pressed in place and may be carefully removed to avoid outgassing. Otherwise, additional processing such as a bake may be required to control outgassing. All other materials have good outgassing characteristics.
3. All contacts are on .050 inch centers between contacts and are size 24.
4. Metal shell connectors are not intermateable with plastic shell connectors.
5. Mounting hardware must be supplied separately. For insert arrangements A through G, use MIL-C-83513/5 configurations A or B. For insert arrangement H, use MIL-C-83513/5 configuration C.
6. Detail specification sheets require M22759/33-26 wire to be substituted for M22759/11-22 wire when connectors with finish "N" are used.
7. Optional color coding in accordance with MIL-STD-681, as modified by detail specification, may be used.

**MIL-C-83513 Microminiature (Notes 1 through 3)
Printed Circuit Connectors, -55°C to +125°C**

Part Number Explanation:					
M83513	/XX-	X	OX	N	X
Military Specification Number	Detail Specification (Table 02-30-1)	Insert Arrangement A = 9 D = 25 G = 51 B = 15 E = 31 H = 100 C = 21 F = 37	PC Termination Length (inches) 01 = .109L 02 = .140L 03 = 172L	Shell Finish N = Electroless Nickel	Hardware N = No Jackpost P = Jackpost (Attached)

Table 02-30-1 Connector Styles

Part Number	Mounting	Type	Applicable Insert Arrangement			
M83513/10-XOXNX	Right Angle	Plug, with Pin Contacts, Narrow Profile (Note 4)	A, B, C, D, E, F			
M83513/11-GOXNX			G			
M83513/12-HOXNX			H			
M83513/13-XOXNX		Right Angle	Receptacle, Socket Contacts, Narrow Profile (Note 4)	A, B, C, D, E, F		
M83513/14-GOXNX				G		
M83513/15-HOXNX				H		
M83513/16-XOXNX			Right Angle	Plug, Pin Contacts, Standard Profile	A, B, C, D, E, F	
M83513/17-GOXNX					G	
M83513/18-HOXNX					H	
M83513/19-XOXNX				Right Angle	Receptacle, Socket Contacts, Standard Profile	A, B, C, D, E, F
M83513/20-GOXNX						G
M83513/21-HOXNX						H
M83513/22-XOXNX	Straight				Plug, Pin Contacts, Standard Profile	A, B, C, D, E, F
M83513/23-GOXNX						G
M83513/24-HOXNX						H
M83513/25-XOXNX		Receptacle, Socket Contacts, Standard Profile			A, B, C, D, E, F	
M83513/26-GOXNX					G	
M83513/27-HOXNX					H	

Notes:

- Connectors are preferred for Grade 2 applications. Consult Appendix A for additional testing required in Grade 1 applications.
- MIL-C-83513 metal shell receptacle connectors contain a thin silicone rubber interface seal which may represent an outgassing concern. The seal is pressed in place and may be carefully removed to avoid outgassing. Otherwise, additional processing such as a bake is recommended to control outgassing. All other materials have good outgassing characteristics.
- All contacts are on .050 inch centers between contacts and are size 24. PC terminations are solid No. 24 AWG copper wire.
- Narrow profile connectors have contact terminations arranged so that additional rows are used in order to reduce overall connector length.

GSFC S-311-P-718 Satellite Interface Connectors (Notes 1 and 2) (Page 1 of 5)
Receptacle, Rectangular, Polarized Shell, EMI Shielded, Crimp Removable Pin Contacts

Part Number Explanation:			
700-42/ GSFC Prefix	X Detail Specification No.	-X Insert Arrangement	-X Contact Type P = Pin S = Socket

GSFC Part Number	GSFC Specification	Shell Size	Pin Contacts, Crimp (Note 3)		GSFC Contact Part Number	For Use With Wire Size (AWG)	
			Qty.	Size			
700-42/3-1-P	S-311-P-718/3	1	8	8	GPP17	8	
					GPP18	12	
					GPP19	10	
			58	16	GPP20	16, 18, 20	
					GPP21	22, 24, 26	
					GCP14	M17/127-RG393	
700-42/3-2-P		1	26	8	GCP15	M17/60-RG142	
					GPP17	8	
					GPP18	12	
			86	16	GPP19	10	
					GPP20	16, 18, 20	
					GPP21	22, 24, 26	
700-42/3-3-P	1	2	RG142 (Note 4)	GCP15	M17/60-RG142		
				244	16	GPP20	16, 18, 20
						GPP21	22, 24, 26
		700-42/3-4-P	1			20	8
				GPP18	12		
				GPP19	10		
144	16			GPP20	16, 18, 20		
				GPP21	22, 24, 26		

See notes on page 02-35.

GSFC S-311-P-718 Satellite Interface Connectors (Notes 1 and 2) (Page 2 of 5)
Receptacle, Rectangular, Polarized Shell, EMI Shielded, Crimp Removable Pin Contacts

GSFC Part Number	GSFC Specification	Shell Size	Pin Contacts, Crimp (Note 3)		GSFC Contact Part Number	For Use With Wire Size (AWG)
			Qty.	Size		
700-42/5-1-P		2	10	16	GPP22	16, 18, 20
					GPP23	22, 24, 26
			4	20	GPP24	20, 22, 24
			88	22	GPP25	22, 24, 26
				RG122 (Notes 4, 5)	GCP29	M17/54-RG122 (Note 5)
700-42/5-2-P	S-311-P-718/5	2	16	16	GCP22	16, 18, 20
					GCP23	22, 24, 26
			52	20	GPP24	20, 22, 24
			2 (Note 6)	RG142 (Note 4)	GCP28	M17/60-RG142
				Triaxial	GTP26	Raychem 9530D5117
	Databus	GDP27	Champion 51-05091			
700-42/6-1-P	S-311-P-718/6	3	8	16	GPP22	16, 18, 20
				GCP23	22, 24, 26	
12			20	GPP24	20, 22, 24	
		20	GPP25	22, 24, 26		
700-42/6-2-P		3	28	20	GPP24	20, 22, 24
		1	RG393 (Note 4)	GCP14	M17/127-RG393	

See notes on page 02-35.

GSFC S-311-P-718 Satellite Interface Connectors (Notes 1 and 2) (Page 3 of 5)
Plug, Rectangular, Polarized Shell, EMI Shielded, Crimp Removable Socket Contacts

GSFC Part Number	GSFC Specification	Shell Size	Pin Contacts, Crimp (Note 3)		GSFC Contact Part Number	For Use With Wire Size (AWG)
			Qty.	Size		
700-42/3-1-S	S-311-P-718/3	1	8	8	GPS10	8
					GPS11	12
					GPS16	10
			58	16	GPS20	16, 18, 20
					GPS21	22, 24, 26
					GCC14	M17/127-RG393
700-42/3-2-S		1	26	8	GCS15	M17/60-RG142
					GPS10	8
					GPS11	12
			86	16	GPS16	10
					GPS20	16, 18, 20
					GPS21	22, 24, 26
700-42/3-5-S	1	2	RG142 (Note 4)	GCS15	M17/60-RG142	
				244	16	GPS20
700-42/3-4-S	1	20	8	GPS21	22, 24, 26	
				GPS10	8	
				GPS11	12	
		144	16	GPS16	10	
				GPS20	16, 18, 20	
				GPS21	22, 24, 26	

See notes on page 02-35.

GSFC S-311-P-718 Satellite Interface Connectors (Notes 1 and 2) (Page 4 of 5)
Plug, Rectangular, Polarized Shell, EMI Shielded, Crimp Removable Socket Contacts

GSFC Part Number	GSFC Specification	Shell Size	Pin Contacts, Crimp (Note 3)		GSFC Contact Part Number	For Use With Wire Size (AWG)
			Qty.	Size		
700-42/5-1-S	S-311-P-718/5	2	10	16	GPS22	16, 18, 20
					GPS23	22, 24, 26
			4	20	GPS24	20, 22, 24
			88	22	GPS25	22, 24, 26
			1	RG122 (Notes 4, 5)	GCS29	M17/54-RG122 (Note 5)
700-42/5-2-S		2	16	16	GPS22	16, 18, 20
					GPS23	22, 24, 26
			52	20	GPS24	20, 22, 24
			2 (Note 6)	RG142 (Note 4)	GCS28	M17/60-RG142
				Triaxial	GTS26	Raychem 9530D5117
	Databus	GDS27	Champlain 51-05091			
700-42/6-1-S	S-311-P-718/6	3	8	16	GPS22	16, 18, 20
				GPS23	22, 24, 26	
12			20	GPS24	20, 22, 24	
20		22	GPS25	22, 24, 26		
700-42/6-2-S		3	28	20	GPS24	20, 22, 24
		1	RG393 (Note 4)	GCS14	M17/127-RG393	

See notes on page 02-35.

GSFC S-311-P-718 Satellite Interface Connectors (Page 5 of 5)

Notes:

1. Connectors are for Grade 1 and Grade 2 applications. Connectors are intended to be used for power and signal interfaces between satellite main structure and subsystem modules. Temperature range for these connectors is -65°C to +125°C.
2. Strain relief backshell kits shall be procured to GSFC Specification S-311-P-718/4. Part numbers are as follows:

Part Number	Accommodating GSFC Connector P/N	Shell Size	Description
G1R	700-42/3-X-X	1	Kit, EMI Backshell with Clamp, Round Entry Hole
G1S	700-42/3-X-X	1	Kit, EMI Backshell with Clamp, Square Entry Hole
G2R	700-42/5-X-X	2	Kit, EMI Backshell with Clamp, Round Entry Hole
G3R	700-42/6-X-X	3	Kit, EMI Backshell with Clamp, Round Entry Hole

3. Connectors are supplied without contacts. Contacts shall be procured to GSFC Specification S-311-P-718/2.

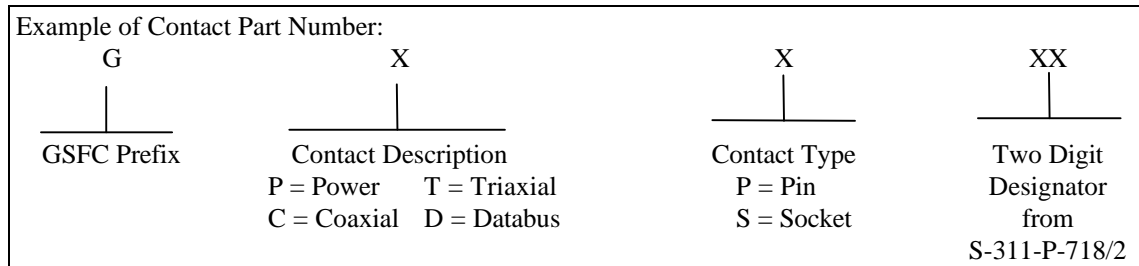

4. Designates coaxial contact for use with coaxial cable from MIL-C-17. Refer to S-311-P-718/2 for coaxial contact installation details.
5. RG122 is for reference only and is not space compatible.
6. Coaxial, triaxial or databus contacts may be used with this connector.

THIS PAGE INTENTIONALLY LEFT BLANK

MIL-C-39029 Contacts, Electrical Connector (Notes 1 through 3) (Page 1 of 2)
Crimp Removable

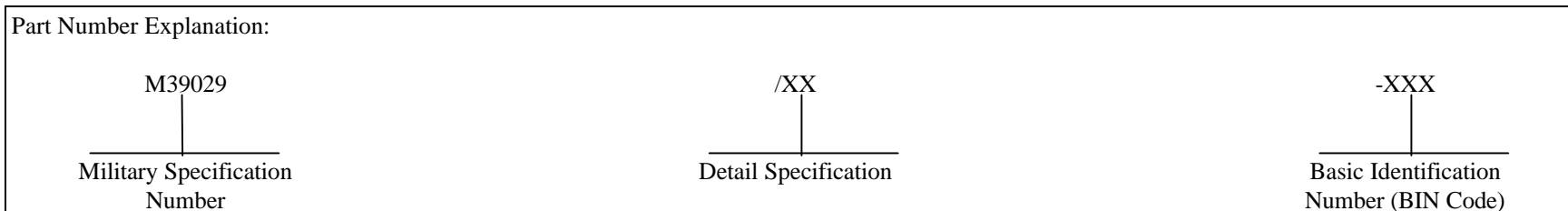

Part Number	Control Specification	Connector Accommodation Specification	Contact Size		Wire Sizes
			Pins	Sockets	
M39029/4-110	MIL-C-39029/4	MIL-C-26482 Series 2	20	X	20, 22, 24
M39029/4-111			16		16, 18, 20
M39029/4-113			12		12, 14
M39029/5-115	MIL-C-39029/5		X	20	20, 22, 24
M39029/5-116				16	16, 18, 20
M39029/5-118				12	12, 14
M39029/29-212	MIL-C-39029/29	MIL-C-5015	16	X	16, 18, 20
M39029/29-213			12		12, 14
M39029/29-214			8		8, 10 (Note 4)
M39029/29-215			4		4, 6 (Note 4)
M39029/29-216			0		0, 1, 2 (Note 4)
M39029/30-218	MIL-C-39029/30		X	16	16, 18, 20
M39029/30-219				12	12, 14
M39029/30-220				8	8, 10 (Note 4)
M39029/30-221				4	4, 6 (Note 4)
M39029/30-222				0	0, 1, 2 (Note 4)
M39029/56-348	MIL-C-39029/56	MIL-C-38999 Series I, III, & IV	X	22D	22, 24, 26
M39029/56-351				20	20, 22, 24
M39029/56-352				16	16, 18, 20
M39029/56-353				12	12, 14

See notes on page 02-38.

MIL-C-39029 Contacts, Electrical Connector (Notes 1 through 3) (Page 2 of 2)
Crimp Removable

Part Number	Control Specification	Connector Accommodation Specification	Contact Size		Wire Sizes
			Pins	Sockets	
M39029/57-354	MIL-C-39029/57	MIL-C-38999 Series II	X	22D	22, 24, 26
M39029/57-357				20	20, 22, 24
M39029/57-358				16	16, 18, 20
M39029/57-359				12	12, 14
M39029/58-360	MIL-C-39029/58	MIL-C-38999 Series I, II, III, & IV	22D	X	22, 24, 26
M39029/58-363			20		20, 22, 24
M39029/58-364			16		16, 18, 20
M39029/58-365			12		12, 14
M39029/63-368	MIL-C-39029/63	MIL-C-24308	—	20	20, 22, 24
M39029/64-369	MIL-C-39029/64		20	—	20, 22, 24
M39029/57-354	MIL-C-39029/57		—	22D	22, 24, 26
M39029/58-360	MIL-C-39029/58		22D	—	22, 24, 26

Notes:

1. Contacts are preferred for Grade 2 applications. Consult Appendix A for additional screening required in Grade 1 applications.
2. Identification color bands on these contacts may be an outgassing concern. Additional processing may be required for outgassing control.
3. Contacts have gold finish per MIL-C-45204, Type II, Grade C, Class 1 (50 microinches, minimum) applied to the contact engagement area. The entire contact is finished in Gold.
4. Electrically conductive bushings as provided in MS3348 should be used when crimping wire sizes 10, 6, and 2 in contact sizes 8, 4, and 0 respectively. Example of P/N: MS3348-8-10 where 8 is contact wire barrel size and 10 is wire size.

MIL-C-85049 Connector Accessories, Electrical (Notes 1 through 3) (Page 1 of 2)

Part Number Explanation: (Refer to detail specification for shell sizes):

M85049	/10 /15 /36 /76	- S - -	XX XX XX XX	N N N N	XX XX	X
Military Specification Number	Detail Specification	S = Self Locking Type Only (Not Available for all Types)	Connector Shell Size	Nickel Finish	Clamp Size	Backshell Length

Notes:

1. Refer to page 02-40 for a table of preferred backshell connector accessories.
2. Preferred for Grades 1 and 2. All backshells in this section are nickel plated and are rated -65°C to +200°C. Consult latest Qualified Products List (QPL) for availability.
3. The use of safety wire is recommended to secure backshells which are not self-locking.
4. When procuring backshell accessories for use with MIL-C-38999 Series I connectors, complete the part number by specifying the equivalent Series II shell size. For example, when ordering Series I shell size 9, specify Series II shell size 8. For shell size 11, specify shell size 10, etc.
5. Environmentally sealed backshells contain a silicone rubber grommet and O ring which represents an outgassing concern. Additional processing for outgassing control, such as a bake, is recommended.
6. Backshell is equipped with an arm which extends from the rear of the backshell body. Strain relief is accomplished through the use of Tefzel tie wraps, lacing twine, or lacing tape, which is tied to the arm, and must be provided separately.
7. Backshell requires M85049/26-2-XX crimp ferrule ring to terminate shield to backshell. Ring is supplied with M85049/26-3, but must be provided separately for M85049/20 and M85049/33-2 backshells. Backshell M85049/26-1 may be used in lieu of M85049/26-3, but crimp ferrule ring M85049/26-2 must be provided separately. Ferrule requires Thomas & Betts Crimp Tool No. 13640 or equivalent and appropriate size die.
8. Ring type backshells have a chamfered edge which, when installed to the rear of the connector, compresses the connector's silicone rubber grommet seal around the exiting wires to provide limited seal and strain relief. Intended for unit mounted connector receptacles only.
9. Backshell is used to terminate the shields of individually shielded wires, or to terminate the shields of several MIL-C-27500 type shielded cables.

MIL-C-85049 Connector Accessories, Electrical (Notes 1 through 3) (Page 2 of 2)

Part Number	Notes	Applicable Connector Procurement Specification				Backshell Description			Strain Relief Type			Configuration		
		5015 Crimp	26482 Series 2	38999 Series		Sealed	Self Locking	Shield Termination	Clamp	Tie Wrap	Ring	Straight	45°	90°
				I & II (Note 4)	III & IV									
M85049/6-XXN	(Note 5)	X	X			X		X	X				X	
M85049/7-XXN	(Note 5)	X	X			X		X	X				X	
M85049/8-XXN	(Note 5)	X	X			X		X	X					X
M85049/9-XXN	(Note 5)	X	X			X		X	X					X
M85049/10-XXN	(Note 5)	X	X			X		X	X		X			
M85049/11-XXN	(Note 5)	X	X			X		X	X		X			
M85049/15SXXN	(Note 6)				X		X			X		X		
M85049/16SXXN	(Note 6)				X		X			X				X
M85049/17XXNXXX	(Note 5)			X		X		X	X		X			
M85049/18XXNXXX	(Note 5)				X	X		X	X		X			
M85049/19XXNXXX					X			X			X			
M85049/20-XXN	(Note 7)				X			X (Crimp Ring)			X			
M85049/23-XXN		X	X					X	X			X		
M85049/24-XXN		X	X					X	X					X
M85049/25-XXN		X	X					X	X		X			
M85049/26-3-XXN	(Note 7)	X	X					X (Crimp Ring)			X			
M85049/27SXXN	(Note 8)			X (Series II Only)			X			X	X			
M85049/30-XXN	(Note 9)			X				X (Daisy Chain)			X			
M85049/31SXXN	(Note 8)	X	X				X			X	X			
M85049/33-2-XXN	(Note 7)			X				X (Crimp Ring)			X			
M85049/36XXNXXX				X				X	X		X			
M85049/38SXXN					X		X		X		X			
M85049/39SXXN					X		X		X		X			X
M85049/43-XXN		X	X						X			X		
M85049/47SNXX				X			X		X					X
M85049/49-2SXXN				X			X		X		X			
M85049/51SXXN		X	X				X		X					X
M85049/52SXXN		X	X				X		X		X			
M85049/56-XXN	(Note 6)			X						X	X			
M85049/57SXXN	(Note 6)			X			X			X		X		
M85049/63SXXN	(Note 6)			X			X			X				X
M85049/76-XXNXX	(Note 5)			X		X		X	X					X
M85049/77-XXNXX	(Note 5)			X		X		X	X			X		
M85049/78-XXNXX	(Note 5)				X	X		X	X			X		
M85049/79-XXNXX	(Note 5)				X	X		X	X					X

See notes on page 02-39.

Summary of Preferred Filters

Control Specification	Description	Minimum Insertion Loss Range -55°C to +125°C (dB)	Frequency Range -55°C to +125°C (Hz)	Grade 1	Grade 2	Refer to Page No.
MIL-F-28861 (Note 1)	RF & EMI suppression	3 - 80	15K - 1.0G	Class S (Note 2)	Class B	03-2

Notes:

1. For stud-mounted filters, do not exceed the rated torque specification.
2. There are currently no Class S filters available.

MIL-F-28861 Filters, Radio Frequency/Electromagnetic Interference Suppression

Part Number Explanation: M28861	/X	-XXX	X	X
Military Specification Number	Detail Specification Number	Dash Number uniquely defines the circuits, rated voltage and current, capacitance, and insertion loss.	Case Finish T = Tin-plated/tin-lead plated S = Silver-plated G = Gold plated (Class S)	Product Assurance Level B = Class B S = Class S

Part Number (Note 1)	Style (Note 2)	Rated Voltage		Rated Current (Amperes)	Operating Temperature Range	Minimum Capacitance Range (µF)	Circuit Type	Frequency Range (Hz)	Minimum Insertion Loss (dB) (Note 3)	Grade	
		(Vdc)	(Vac)							1	2
M28861/1-XXXXX	FS10, 11	50-200	125 (0 to 400 Hz) (Note 4)	15	-55°C to +125°	0.15 - 0.7	C or L ₂	30K - 1.0G	7-40	Class S (Note 5)	Class B
M28861/2-XXXXX	FS20	100	-	0.25 - 5.0		0.45 - 0.9	L ₁ L ₂ or P ₁	100K - 1.0G	12-80		
M28861/4-XXXXX	FS40	70	-	0.1 - 5.0		0.70 - 1.4	L ₁ L ₂ or P ₁	15K - 1.0G	3-80		
M28861/5-XXXXX	FS50	200	125 (0 to 400 Hz)	0.25 - 5.0		0.15 - 0.3	L ₁ L ₂ or P ₁	100K - 1.0G	3-80		

Notes:

1. Parts covered by these specifications contain internal solder connections that may reflow during installation. Special care must be exercised when soldering to prevent internal solder reflow.
2. Style is denoted by FS followed by a two digit number, which indicates the voltage rating, envelope size and configuration.
3. Minimum insertion loss values are given in Table 1 of each detail specification (slash sheet) for frequency increments within the specified range over the temperature range of -55°C to +125°C.
4. Only dash numbers 009, 010, 019, and 020 have AC voltage ratings.
5. There are currently no Class S filters available.

Summary of Preferred Fuses (Note 1)

Style and Characteristic (Note 2)	Description	Specification	Current Range (Note 3) (Amperes)	Voltage Rating (Note 4) (Volts)	Grades	Refer To Page No.
FM08A	Subminiature, High Performance, Cartridge, Instrument Type	MIL-F-23419/8	1/8 - 10 15	125 32	1	Page 04-2
FM04A	Subminiature, Nonindicating, Cartridge, Instrument Type	MIL-F-23419/4	1/8 - 15	125	2	Page 04-2

Notes:

1. All electrical ratings are both direct current (dc) and alternating current (ac) up to 400 hertz.
2. Characteristic "A" denotes the fuse has a normal relative overload interrupt time, commonly referred to as a "normal blow" fuse. This fuse contains a single element with no intentional time delay designed into the element.
3. Current rating is defined in MIL-F-23419 as the amount of current a fuse will carry indefinitely without interruption. This should not be construed to mean that these fuses will operate for an infinite time at rated load current. For all amperages, continuous operation at 100% of load will degrade the fuse and cause it to open after a finite period of time. For example, one of the FM08 manufacturers advertises that these fuses, when operated at 100% of load, have a 4 hours (minimum) opening time.
4. The voltage rating is the maximum direct current (dc) or alternating current (ac) voltage for which a fuse is designed.

MIL-F-23419 Fuses, Subminiature (Axial Leads) (Notes 1, 2)

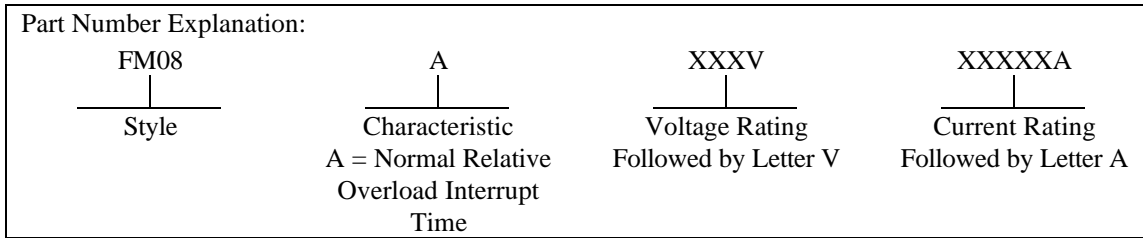

(Note 3) Current Rating (Amperes)	Maximum Rated Voltage (Volts)	Grade 1			Grade 2	
		Part Number (Note 4)	Voltage Drop @ Rated Current (Volts)	Cold Resistance Limits (Ohms)	Part Number (Note 5)	Maximum Cold Resistance (Ohms)
1/8	125	FM08A125V1/8A	.85 - 1.15	1.89 - 2.31	FM04A125V1/8A	2.70
1/4		FM08A125V1/4A	.590 - .800	.639 - .781	FM04A125V1/4A	.960
3/8		FM08A125V3/8A	.527 - .713	.378 - .462	FM04A125V3/8A	.560
1/2		FM08A125V1/2A	.488 - .660	.252 - .308	FM04A125V1/2A	.365
3/4		FM08A125V3/4A	.145 - .197	.153 - .187	FM04A125V3/4A	.215
1		FM08A125V1A	.157 - .213	.112 - .138	FM04A125V1A	.165
1 1/2		FM08A125V1.5A	.153 - .207	.072 - .088	FM04A125V1-1/2A	.105
2		FM08A125V2A	.144 - .196	.0495 - .0605	FM04A125V2A	.072
2 1/2		FM08A125V2.5A	.125 - .169	.0378 - .0462	-----	----
3		FM08A125V3A	.139 - .187	.0315 - .0388	FM04A125V3A	.047
4		FM08A125V4A	.110 - .150	.0207 - .0253	FM04A125V4A	.029
5		FM08A125V5A	.087 - .118	.0126 - .0154	FM04A125V5A	.019
7		FM08A125V7A	.087 - .118	.0090 - .0110	FM04A125V7A	.013
10		FM08A125V10A	.085 - .110	.0059 - .0070	FM04A125V10A	.008
15		32	FM08A32V15A	.065 - .087	.0036 - .0044	FM04A32V15A

Notes:

1. All preferred subminiature fuses shall be subjected to additional testing in accordance with Table 04 of Appendix A.
2. Subminiature fuses are not mechanically rugged and are heat sensitive. Use special handling and soldering for these parts. These fuses are particularly susceptible to lead bending. If lead forming is required, always support the lead between the endcap and desired bend area prior to bending. *Never bend the lead while grasping the fuse body.*
3. THE FLIGHT USE OF FUSES RATED 1/2 AMPERE AND LESS REQUIRES APPLICATION APPROVAL BY THE APPLICABLE GSFC PROJECT OFFICE. EVIDENCE OF APPLICATION CURRENT LEVELS (INCLUDING STEADY-STATE, REPETITIVE PULSES AND TRANSIENTS) MUST BE SUBMITTED WITH THE REQUEST FOR APPROVAL.
4. The applicable military specification is MIL-F-23419/8.
5. The applicable military specification is MIL-F-23419/4.

Summary of Preferred Coils/Inductors

Specification	Description	Inductance Range		Q (min) Range	FRL		Refer to Page No.
		Min	Max		Grade 1	Grade 2	
MIL-C-39010	Fixed, molded, radio frequency	0.1 μ H	100.0 mH	75 - 18	S (Note 1)	R, P	05-2
MIL-C-83446	Chip, radio frequency, fixed or variable	0.01 μ H	1,000 μ H	75 - 19	Note 2		05-3

Notes:

1. There are currently no failure rate level S parts available. Failure rate level R or P parts may be used in Grade 1 applications if they meet the Class S requirements of MIL-STD-981.
2. Failure rate level is not applicable. These inductors may be used in Grade 2 applications. They may be used in Grade 1 applications if they meet the Class S requirements of MIL-STD-981 (Groups A and B testing).

MIL-C-39010 Coils

Fixed, Radio Frequency, Molded, Established Reliability

Part Number Explanation:					
M39010 Military Specification Number	/XX Slash Sheet Number Specifies the inductor family	-X Class Maximum Operating Temperature A = +105°C B = +125°C F = +150°C	XXX Inductance in microhenries (μH) The first two digits indicate significant figures, and the third digit indicates the number of zeros. For less than 10μH, two digits represent significant figures and the letter (R) represents the decimal point location.	X Tolerance J = ±5% K = ±10% L = ±20%	X Failure Rate Level % per 1000 hrs S = .001 R = .01 P = .1

Part Number (Note 1)	Inductance Range (μH)	Inductance Tolerance (±%)	Q Min Range	Self Resonant Frequency (MHz) Min	Rated dc Current (mA)	Core Type	Construction	Operating Temperature (°C)		FRL	
								Min	Max	Grade 1	Grade 2
M39010/01-AXXXXX	0.10 - 0.82	5, 10	40 - 50	180 - 250	370 - 1790	Phenolic core & iron sleeve	Shielded	-55	+105	S	P
M39010/02-AXXXXX	1.00 - 12.0		44 - 55	44 - 140	200 - 1070	Iron					
M39010/03-AXXXXX	15 - 100,000		18 - 60	0.11 - 49	11 - 315	Ferrite					
M39010/06-BXXXXX	0.15 - 4.7	5, 10, 20	33 - 50	90 - 525	260 - 2450	Phenolic	Unshielded	-55	+125		
M39010/07-AXXXXX	5.6 - 33	5, 10	45 - 75	19 - 60	165 - 495	Iron	Unshielded	-55	+105		

Notes:

1. Parts covered by this specification may contain internal soldered connections that may reflow during installation. Special care must be exercised when soldering to prevent internal solder reflow.
2. There are currently no failure rate level S parts available. Level P parts may be used in Grade 1 applications if they meet the Class S requirements (Groups A and B) of MIL-STD-981, for radio frequency fixed coils (Family 13).

MIL-C-83446, Coils
Chip, Fixed or Variable, Radio Frequency

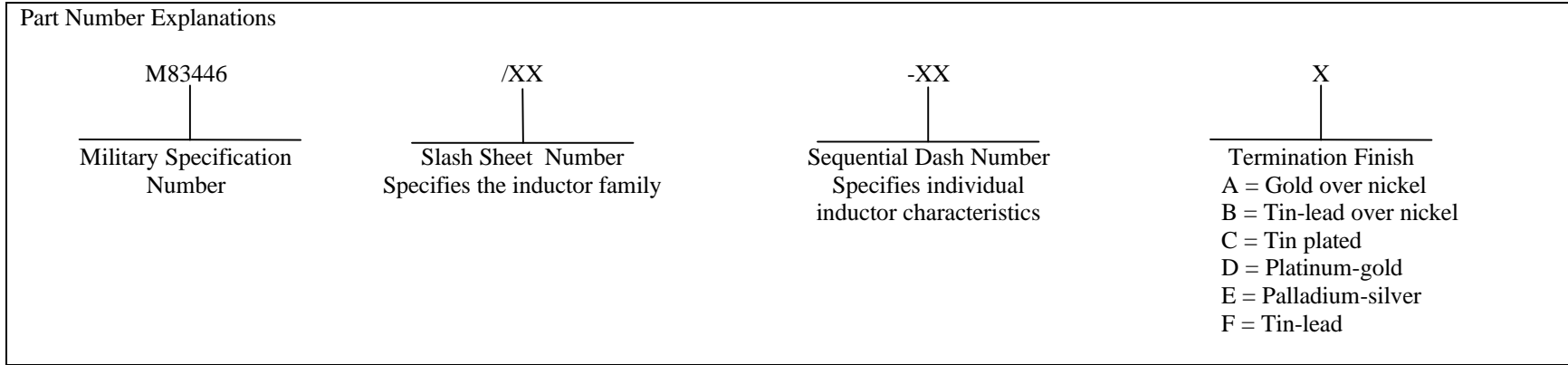

Part Number	Inductance Range (μH)	Inductance Tolerance (±%)	Q Min Range	Self Resonant Frequency (MHz) Min	Rated dc Current (mA)	Configuration	Construction	Operating Temperature (°C)		Grade	
								Min	Max	1	2
M83446/04-XXX	0.010 - 27.0	10, 20	22 - 60	22.0 - 2700	120 - 1270	Fixed	Unshielded	-55	+125		(Note 1)
M83446/05-XXX	0.01 - 10.0	10	42 - 60	33.0 - 2000	87 - 750	Fixed					
M83446/07-XXX	0.016 - 76.1	—	19 - 55	5.0 - 1200	22 - 750	Variable					
M83446/09-XXX	0.015 - 150	—	22 - 55	3.0 - 1200	22 - 750	Variable					
M83446/10-XXX	0.01 - 1000.0	10	30 - 75	1.7 - 2000	25 - 1000	Fixed					

Notes:

- These inductors may be used in Grade 1 applications only if they meet the Class S requirements of MIL-STD-981. They may be used “as is” for Grade 2 applications.

THIS PAGE INTENTIONALLY LEFT BLANK

Summary of Preferred Relays

Grade 1		Grade 2 (Note 1)	Description	Contact Rating @ 28Vdc (A)	Nominal Coil Voltage Range (Vdc)	Coil Resistance Range (Ohms)	Refer to Page No.
GSFC Detail Specification No.	REPLACES (Note 2)	Military Detail Specification No.					
S-311-P-754/01	S-311-P-2(06)/33	MIL-R-39016/12	Latching, 2PDT	1	6.0 - 26.5	120 - 2000	06-2
S-311-P-754/02	S-311-P-2(06)/37	MIL-R-39016/29	Latching, 2PDT	1	6.0 - 26.5	120 - 2000	06-2
S-311-P-754/03	S-311-P-2(06)/39	MIL-R-39016/9	Nonlatching, 2PDT	1	6.0 - 26.5	98 - 1560	06-3
S-311-P-754/04	S-311-P-2(06)/48	MIL-R-39016/15	Nonlatching, 2PDT	1	6.0 - 26.5	98 - 1560	06-3
S-311-P-754/05	S-311-P-2(06)/64	(Note 3)	Nonlatching, 2PDT	1	6.0 - 26.5	70 - 1130	06-3
S-311-P-754/06	S-311-P-2(06)/23	MIL-R-6106 (MS27401)	Nonlatching, 2PDT	10	28.0	320	06-3
S-311-P-754/07	S-311-P-2(06)/47	MIL-R-39016/13	Nonlatching, 2PDT	2	6.0 - 26.5	56 - 1350	06-3
S-311-P-754/08	S-311-P-2(06)/27	MIL-R-39016/31	Latching, 4PDT	2	26.5	975	06-2
S-311-P-754/09	S-311-P-2(06)/42	MIL-R-39016/14	Nonlatching, 4PDT	1	6.0 - 26.5	28 - 720	06-3
S-311-P-754/10	S-311-P-2(06)/19	MIL-R-6106 (MS27400)	Nonlatching, 4PDT	10	28.0	290	06-3
S-311-P-754/11	S-311-P-2(06)/35	MIL-R-6106 (MS27742)	Latching, 3PDT	25	28.0	450	06-2
		MIL-R-39016/6	Nonlatching, 2PDT	2	5.0 - 26.5	27 - 700	06-3
		MIL-R-39016/11	Nonlatching, 2PDT	1	5.0 - 48.0	100 - 11000	06-3
		MIL-R-39016/20	Nonlatching, 2PDT	1	5.0 - 26.5	39 - 1560	06-3
		MIL-R-39016-21	Nonlatching, 2PDT	1	5.0 - 48.0	64 - 11000	06-3
		MIL-R-39016/38	Nonlatching, 2PDT	2	5.0 - 26.5	44 - 1350	06-3

Notes:

1. A DPA is required per GSFC specification S-311-M-70 if cleaning and small particle inspection are not performed. The purchase order must specify that relays shall be supplied with unpainted enclosures, and no cadmium or zinc (internal or external) shall be used.
2. GSFC S-311-P2(06) and the detail specification sheets listed below were "Canceled with replacement. See S-311-P-754." on 12/23/92. The remaining GSFC S-311-P2(06) detail specification sheets were "Canceled without replacement."
3. An equivalent military specified relay is not available.

Relays, Latching

Grade 1		Grade 2	Electrical Data (Note 3)				Mechanical Data		
GSFC Specification S-311-P-754	REPLACES GSFC Specification S-311-P2(06)	Military Part Number	Contact Rating at 28 Vdc (Note 2) (Amps)	Coil Voltage		Nominal Coil Resistance (Ohms)	Contact Form (Note 4)	Package Type	Terminal Type
				Nominal (Vdc)	Pick-up (Max Vdc)				
G311P754/01-001	P2/33-05	M39016/12-056M	1	6.0	4.5	120	2 Form C (2PDT)	TO-5 Can	Wire Leads
G311P754/01-002	P2/33-04	M39016/12-057M		9.0	6.8	280			
G311P754/01-003	P2/33-03	M39016/12-058M		12.0	9.0	500			
G311P754/01-004	P2/33-02	M39016/12-059M		18.0	13.5	1130			
G311P754/01-005 (Note 1)	P2/33-01	M39016/12-060M		26.5	18.0	2000			
G311P754/02-001	P2/37-05	M39016/29-056M	1	6.0	4.5	120	2 Form C (2PDT)	TO-5 Can	Wire Leads
G311P754/02-002	P2/37-04	M39016/29-057M		9.0	6.8	280			
G311P754/02-003	P2/37-03	M39016/29-058M		12.0	9.0	500			
G311P754/02-004	P2/37-02	M39016/29-059M		18.0	13.5	1130			
G311P754/02-005 (Note 1)	P2/37-01	M39016/29-060M		26.5	18.0	2000			
G311P754/08-003	P-2(06)/27-01	M39016/31-003M	2.0 (Note 5)	26.5	13.5	975	4 Form C (4PDT)	Low Profile	Pins
G311P754/11-001	P-2(06)/35-01	MS27742-1	25.0	28.0	18.0	---	3 Form C (3PDT)	One Inch Cube	Solder Hook
G311P754/11-002	P-2(06)/35-02	MS27742-2							Plug-in

Notes:

1. The GSFC relay part numbers specify a 1.500 inch minimum lead length, whereas the corresponding MIL relay part numbers specify a 0.500 inch minimum lead length.
2. Contact ratings for other types of loads (inductive, capacitive, lamp, motor, etc.) can be obtained from the detail specifications.
3. Electrical data are for +25°C except for MS relay pickup voltages (latch and reset) which are specified over the rated temperature range.
4. Refer to the NARM Engineers' Relay Handbook for definition of forms (example: form C = single pole, double throw, break before make).
5. The contacts are also suitable for low level applications.

Relays, Nonlatching (Page 1 of 2)

Grade 1		Grade 2	Electrical Data (Note 3)				Mechanical Data		
GSFC Specification S-311-P-754	REPLACES GSFC Specification S-311-P2(06)	Military Part Number	Contact Rating at 28 Vdc (Note 2) (Amps)	Coil Voltage		Nominal Coil Resistance (Ohms)	Contact Form (Note 4)	Package Type	Terminal Type
				Nominal (Vdc)	Pick-up (Max Vdc)				
G311P754/03-001	P2/39-05	M39016/9-058M	1.0 (Note 5)	6.0	3.5	98	2 Form C (2PDT)	TO-5 Can	Wire Leads
G311P754/03-002	P2/39-04	M39016/9-059M		9.0	5.3	220			
G311P754/03-003	P2/39-03	M39016/9-060M		12.0	7.0	390			
G311P754/03-004	P2/39-02	M39016/9-061M		18.0	10.5	880			
G311P754/03-005 (Note 1)	P2/39-01	M39016/9-062M		26.5	14.2	1560			
G311P754/04-001	P-2/48-05	M39016/15-077M	1.0 (Note 5)	6.0	3.5	98	2 Form C (2PDT)	TO-5 Can	Wire Leads
G311P754/04-002	P-2/48-04	M39016/15-078M		9.0	5.3	220			
G311P754/04-003	P-2/48-03	M39016/15-079M		12.0	7.0	390			
G311P754/04-004	P-2/48-02	M39016/15-080M		18.0	10.5	880			
G311P754/04-005 (Note 1)	P-2/48-01	M39016/15-081M		26.5	14.2	1560			
G311P754/05-001	P-2/64-05	N/A	1.0 (Note 5)	6.0	5.5	70	2 Form C (2PDT)	TO-5 Can	Wire Leads
G311P754/05-002	P-2/64-04	N/A		9.0	8.2	155			
G311P754/05-003	P-2/64-03	N/A		12.0	11.0	235			
G311P754/05-004	P-2/64-02	N/A		18.0	16.5	610			
G311P754/05-005	P-2/64-01	N/A		26.5	22.0	1130			
G311P754/06-001	P-2(06)/23-01	MS27401-5M	10.0	28.0	18.0	320	2 Form C (2PDT)	1/2 Crystal Can	Solder Hook
G311P754/06-002	P-2(06)/23-02	MS27401-6M							Socket Pin
G311P754/07-001	P-2/47-03	M39016/13-064M	2.0 (Note 5)	6.0	2.7	56	2 Form C (2PDT)	1/2 Crystal Can	Solder Lugs
G311P754/07-002	P-2/47-02	M39016/13-065M		12.0	5.4	210			
G311P754/07-003	P-2/47-01	M39016/13-066M		26.5	13.5	1350			
G311P754/09-001	P-2/42-03	M39016/14-002M	1.0 (Note 5)	6.0	2.7	28	4 Form C (4PDT)	Low Profile	Pins
G311P754/09-002	P-2/42-02	M39016/14-007M		12.0	5.4	115			
G311P754/09-003	P-2/42-01	M39016/14-005M		26.5	13.5	720			
G311P754/10-001	P-2(06)/19-01	MS27400-5M	10.0	28.0	18.0	290	4 Form C (4PDT)	One Inch Cube	Solder Hook
G311P754/10-002	P-2(06)/19-02	MS27400-6M							Socket Pin

Relays, Nonlatching (Page 2 of 2)

Grade 1		Grade 2	Electrical Data (Note 3)				Mechanical Data		
GSFC Specification S-311-P-754	REPLACES GSFC Specification S-311-P2(06)	Military Part Number	Contact Rating at 28 Vdc (Note 2) (Amps)	Coil Voltage		Nominal Coil Resistance (Ohms)	Contact Form (Note 4)	Package Type	Terminal Type
				Nominal (Vdc)	Pick-up (Max Vdc)				
N/A	N/A	M39016/6-XXXXP	2	(Note 6)	(Note 6)	(Note 6)	(Note 6)	(Note 6)	(Note 6)
N/A	N/A	M39016/11-XXXXP	1	(Note 6)	(Note 6)	(Note 6)	(Note 6)	(Note 6)	(Note 6)
N/A	N/A	M39016/20-XXXXP	1	(Note 6)	(Note 6)	(Note 6)	(Note 6)	(Note 6)	(Note 6)
N/A	N/A	M39016/21-XXXXP	1	(Note 6)	(Note 6)	(Note 6)	(Note 6)	(Note 6)	(Note 6)
N/A	N/A	M39016/38-XXXXP	2	(Note 6)	(Note 6)	(Note 6)	(Note 6)	(Note 6)	(Note 6)

Notes:

1. The GSFC relay part numbers specify a 1.500 inch minimum lead length, whereas the corresponding MIL relay part numbers specify a 0.500 inch minimum lead length.
2. Contact ratings for other types of loads (inductive, capacitive, lamp, motor, etc.) can be obtained from the Parts Branch specialist.
3. Electrical data are for +25°C except for MS relay pickup voltages (latch and reset) which are specified over the rated temperature range.
4. Refer to the NARM Engineers' Relay Handbook for definition of forms (example: form C = single pole, double throw, break before make).
5. The contacts are also suitable for low level applications.
6. Refer to the applicable detail specification for electrical and mechanical information regarding the part selected.

Summary of Preferred Resistors

Control Specification	Style	Description	Resistance Range (Notes 1, 2) (Ohms)		Power Range (Watts)		FRL		Refer to Page No.
			Min	Max	Min	Max	Grade 1	Grade 2	
S-311-P-672	G311P672	Fixed, High Voltage	1K	100,000M	0.25	1.0	(Note 3)	(Note 3)	07-2
S-311-P-683	G311P683	Fixed, Precision, High Voltage	200	750M	0.5	7.5	(Note 3)	(Note 3)	07-3
S-311-P-742	G311P742	Fixed, Low TC, Precision	1K	1.5M	0.2	0.3	(Note 3)	(Note 3)	07-4
MIL-R-39005 (Note 4)	RBR	Fixed, Wirewound (Accurate), ER	4.99	1.37M	0.125	0.75	R	P or R	07-5
MIL-R-39007 (Note 4)	RWR	Fixed, Wirewound (Power Type), ER	0.1	39.2K	1.0	10.0	S	P or R	07-6
MIL-R-39008	RCR	Fixed, Composition (Insulated), ER	1.0	22M	0.125	2.0	S	P or R	07-8
MIL-R-39009 (Note 4)	RER	Fixed, Wirewound (Power Type), Chassis Mounted, ER	0.1	39.2K	5.0	30.0	R	P or R	07-10
MIL-R-39015 (Notes 4, 5)	RTR	Variable, Wirewound (Lead Screw Actuated), ER	10.0	10K	0.75	0.75	R	P or R	07-12
MIL-R-39017	RLR	Fixed, Film (Insulated), ER	4.3	10M	0.125	1.0	S	P or R	07-13
MIL-R-55182	RNX	Fixed, Film, ER	4.99	3.01M	0.05	0.5	S	P or R	07-14
MIL-R-55342	RM	Fixed, Film, Chip, ER	5.6	15M	0.05	1.0	S	P or R	07-17
MIL-R-83401 (Note 5)	RZ	Networks, Fixed, Film	27.4	1M	0.025	1.6	(Note 6)	(Note 6, 7)	07-19

Notes:

1. The resistance range reflects values listed in the QPL at the time of issue. With the exception of wirewound resistors (see Note 4), all new resistance values, characteristics, and tighter tolerances are considered preferred when listed in the QPL at the failure rate level (FRL) specified above.
2. The resistance may be any value within the limits listed in the military specification QPL. However, it is preferred that resistance values be chosen from the decade table contained in the applicable military specification. Part numbers containing nonstandard combinations of resistance values and tolerances may be considered nonconforming to the specification and not carry the JAN certification mark.
3. Parts are acceptable for Grade 1 and Grade 2 applications.
4. The maximum resistance value of preferred wirewound resistors is constrained by the size of the wire used in their construction. GSFC prohibits the use of wire smaller than 0.001 inch (0.03 mm) in nominal diameter. Consult the applicable detail specification for wire size information.
5. Parts covered by this specification may contain internal soldered connections that may reflow during installation. Special care must be exercised during soldering to prevent internal solder reflow. Parts manufactured without solder terminations are recommended for space flight use. Consult manufacturers for construction details.
6. Parts are acceptable for Grade 2 application only.
7. Parts manufactured with internal solder terminations shall be subjected to additional testing in accordance with Table 07 of Appendix A.

S-311-P-672 Resistors (Note 1)
Fixed, Film, High Voltage

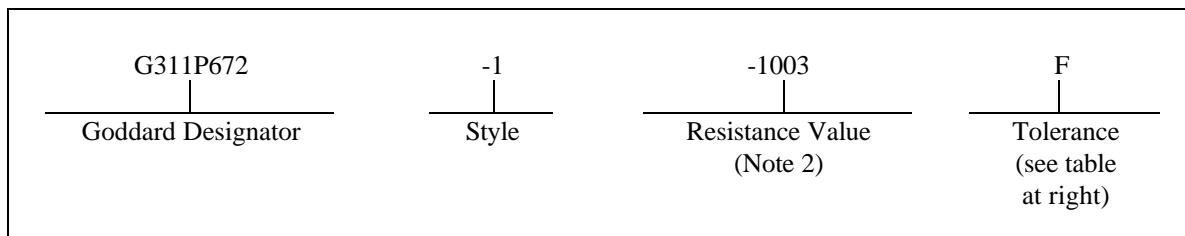

Tolerance	
D	± .5%
F	± 1%
G	± 2%
J	± 5%
K	± 10%

Style	Resistance Range (Ohms)	Power Rating @ 70°C (Watts)	Maximum Voltage Rating (Volts)	Available Tolerances (±%)	Standard Resistance Values	Resistance Temperature Characteristic (Referenced to +25°C)			Resistor Type (Note 4)
						100 ppm/°C	250 ppm/°C	500 ppm/°C	
1	1 KΩ to 10,000 MΩ	0.25	1000	0.5, 1, 2	(Note 3)	10 KΩ - 500 MΩ	501 - 1,000 MΩ	1,001 - 30,000 MΩ	MOX-400-23
	1 KΩ to 30,000 MΩ			5, 10		20 KΩ - 1,000 MΩ	1,001 - 2,000 MΩ	2,001 - 70,000 MΩ	
2	1 KΩ to 10,000 MΩ	0.50	2000	0.5, 1, 2					50 KΩ - 1,500 MΩ
	1 KΩ to 70,000 MΩ			5, 10					
3	1 KΩ to 10,000 MΩ	1.0	5000	0.5, 1, 2		1,500 MΩ	3,000 MΩ	100,000 MΩ	MOX-1125-23
	1 KΩ to 100,000 MΩ			5, 10					

Notes:

1. These resistors are acceptable for Grade 1 and Grade 2 applications.
2. Nominal resistance in ohms is identified by four digits. The first three are significant figures; the last digit is the number of following zeros. (example: 1003 = 100,000 Ω or 100kΩ).
3. There are no standard resistance values. Parts can be manufactured to any resistance value, as specified in Note 2, within the allowable resistance range.
4. The manufacturer's designation.

S-311-P-683 Resistors (Note 1)
Fixed, Film, High Voltage, Precision

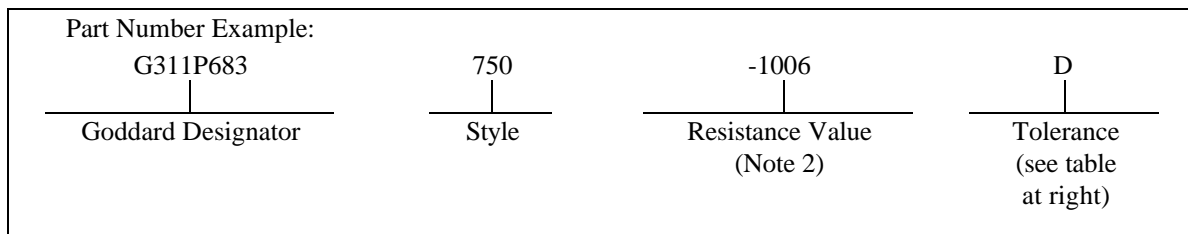

Tolerance	
B	± 0.10%
C	± 0.25%
D	± 0.50%
E	± 1%

Style	Resistance Range (Ohms)		Power Rating @ 70°C (Watts)	Maximum Voltage Rating (Volts)	Available Tolerances (%)	Standard Resistance Values	Resistance Temperature Characteristic (Referenced to +25°C)		Resistor Type (Note 3)
	Minimum	Maximum					-15°C to +105°C	-55°C to +125°C	
650	200 Ω	5 MΩ	0.5	600	(Note 4) ± .10 ± .25 ± .50 ± 1	(Note 5)	± 80 ppm/°C	± 140 ppm/°C	HG, MG650
660	400 Ω	10 MΩ	0.6	1,000					HG, MG660
680	600 Ω	20 MΩ	0.8	2,000					HG, MG680
710	800 Ω	50 MΩ	1.0	4,000					HG, MG710
714	200 Ω	20 MΩ	1.0	1,000					HG, MG714
715	400 Ω	50 MΩ	1.0	2,000					HG, MG715
716	600 Ω	75 MΩ	1.5	4,000					HG, MG716
720	1 KΩ	150 MΩ	2.0	6,000					HG, MG720
721	200 Ω	100 MΩ	2.0	4,000					HG, MG721
725	1.5 KΩ	200 MΩ	2.5	10,000					HG, MG725
730	500 Ω	250 MΩ	3.0	6,000					HG, MG730
750	400 Ω	500 MΩ	5.0	10,000					HG, MG750
780	600 Ω	750 MΩ	7.5	15,000					HG, MG780

Notes:

1. Resistors are acceptable for Grade 1 and Grade 2 applications.
2. Nominal resistance in ohms is identified by four digits. The first three are significant figures; the last digit is the number of following zeros. (example: 1006 = 100,000,000 Ω or 100 MΩ).
3. The manufacturer's designation.
4. Resistors to tolerance B or C are derated to 50% of rated power with applied voltage not to exceed 50% of rated voltage.
4. All values of nominal resistance from the minimum to the maximum listed above are considered to be standard values due to the manufacturer's complex metal oxide technology.

S-311-P-742 Resistors (Note 1)
Fixed, Low TC, Precision, Radial-Lead

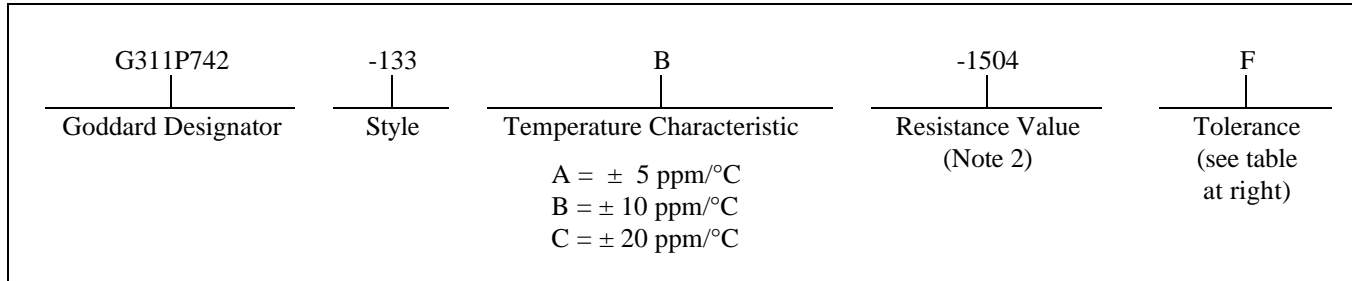

Tolerance	
A	± .05%
B	± .1%
C	± .25%
D	± .5%
F	± 1%
G	± 2%

Style	Temperature Characteristic (-55 to +125°C) (ppm/°C)	Resistance Range (Ohms)		Power Rating @ 125°C (Watts)	Maximum Voltage Rating (Volts)	Available Tolerances (±%)	Standard Resistance Values	Resistor Type (Note 4)
		Minimum	Maximum					
121	A, B, C	1KΩ	500KΩ	0.2	200	A, B, C, D, F, G	(Note 3)	TK121
133	A, B, C	1KΩ	1.5MΩ	0.3	300	A, B, C, D, F, G		TK133
139	A, B, C	1KΩ	1.5MΩ	0.3	300	A, B, C, D, F, G		TK139

Notes:

1. These resistors are acceptable for Grade 1 and Grade 2 applications.
2. Nominal resistance in ohms is identified by four digits. The first three are significant figures; the last digit is the number of following zeros. (example: 1504 = 1,500,000 Ω or 1.5MΩ).
3. All values of nominal resistance from the minimum to the maximum listed above are considered to be standard values due to the manufacturer's complex metal oxide technology.
4. The manufacturer's designation.

MIL-R-39005 Resistors Fixed, Wirewound (Accurate), Established Reliability

Part Number Explanation:

RBR	XX	X	XXXX	X	X	X
MIL-R-39005	Size	Terminal Characteristics	Significant Figures	Number of Zeros	Resistance Tolerance (±%)	Failure Rate (% per 1000 hrs.)
Style		L = Solderable U = Weldable	Resistance (Notes 1, 2)		T = 0.01 Q = 0.02 A = 0.05 B = 0.10	P = 0.1 R = 0.01

RBR identifies established reliability, accurate, wirewound, fixed resistors. "XX" represents a number which identifies the size and power rating of the resistors.

Part Number	Control Specification	Style Size	Characteristics				Maximum Voltage (Vdc)	FRL	
			Rated Power at +125°C (Watts)	Resistance (Ohms)		Tolerance (±%)		Grade 1	Grade 2
				Range (Note 3)					
				Min	Max				
RBR52XXXXXXXXXX	MIL-R-39005/1	RBR52	1/2	10	806K	Q, A, B, T	600	R	P
RBR54XXXXXXXXXX	MIL-R-39005/3	RBR54	1/4	4.99	255K				
RBR56XXXXXXXXXX	MIL-R-39005/5	RBR56	1/8	10	100K				
RBR57XXXXXXXXXX	MIL-R-39005/7	RBR57	3/4	10	1.37M				
RBR71XXXXXXXXXX	MIL-R-39005/6	RBR71	1/8	10	100K				
RBR75XXXXXXXXXX	MIL-R-39005/9	RBR75	1/8	10	71.5K				

Notes:

- For $R \geq 1000\Omega$, the first four digits are significant figures, the fifth is the number of following zeros. For $R < 1000\Omega$, the letter R replaces one of the digits and is used as a decimal point; the remaining digits are significant figures.
- Select a standard resistance value for the 10 to 100 decade from Table III in MIL-R-39005 (see Note 2 on page 07-1).
- The maximum resistance value of preferred wirewound resistors is constrained by the size of the wire used in their construction. GSFC prohibits the use of wire smaller than 0.001 inch (0.03 mm) in nominal diameter. Consult the applicable detail specification for wire size information.

MIL-R-39007 Resistors (Page 1 of 2)
Fixed, Wirewound (Power Type), Established Reliability

Part Number Explanation:

RWR	XX	X	XXX	X	X	X
MIL-R-39007	Size	Terminal Characteristics	Significant Figures	Number of Zeros	Resistance Tolerance (±)	Failure Rate (% per 1000 hrs.)
<p>Style</p> <p>RWR identifies established reliability, axial lead, power type, wirewound, fixed resistors. "XX" represents a number which identifies the size wattage rating and construction of the resistors.</p>	<p>W = Weldable, inductively wound</p> <p>S = Solderable, inductively wound</p> <p>N = Solderable, noninductively wound</p> <p>Z = Weldable, noninductively wound</p>	<p>Resistance (Notes 1, 2)</p>	<p>B = 0.1%</p> <p>D = 0.5%</p> <p>F = 1.0%</p>	<p>P = 0.1</p> <p>R = 0.01</p> <p>S = 0.001</p>		

Part Number	Control Specification	Style Size	Characteristics							
			Rated Power at +25°C (Watts)	Terminal Characteristics	Resistance Range (Notes 3, 4) (Ohms)		Tolerance (±%)	Maximum Voltage Rating	FRL	
					Min	Max			Grade 1	Grade 2
RWR78XXXXXXXX	MIL-R-39007/7	RWR78	10	S,W N,Z	0.1 0.1	39,200 19,600	0.1, 0.5, 1.0	E = √PR	S	P or R
RWR80XXXXXXXX	MIL-R-39007/8	RWR80	2	S,W N,Z	0.1 0.1	1,210 640				
RWR81XXXXXXXX	MIL-R-39007/9	RWR81	1	S,W N,Z	0.1 0.1	492 234				
RWR84XXXXXXXX	MIL-R-39007/10	RWR84	7	S,W N,Z	0.1 0.1	12,400 6,190				
RWR89XXXXXXXX	MIL-R-39007/11	RWR89	3	S,W N,Z	0.1 0.1	3,570 1,780				

See notes on page 07-7.

MIL-R-39007 Resistors (Page 2 of 2)
Fixed, Wirewound (Power Type), Established Reliability

Notes:

1. For $R \geq 100 \Omega$, the first three digits are significant figures, the fourth is the number of following zeros. For $R < 100 \Omega$, the letter R replaces one of the digits and is used as a decimal point; the remaining digits are significant figures.
2. Select a standard resistance value for the 10 to 100 decade from Table III in MIL-R-39007 (see Note 2 on page 07-1).
3. For tolerance "B" ($\pm 0.1\%$), terminal characteristics S, W, N and Z, the minimum resistance value is 0.499 ohms.
4. The maximum resistance value of preferred wirewound resistors is constrained by the size of the wire used in their construction. GSFC prohibits the use of wire smaller than 0.001 inch (0.03 mm) in nominal diameter. Consult the applicable detail specification for wire size information.

MIL-R-39008 Resistors (Page 1 of 2)
Fixed, Composition (Insulated), Established Reliability

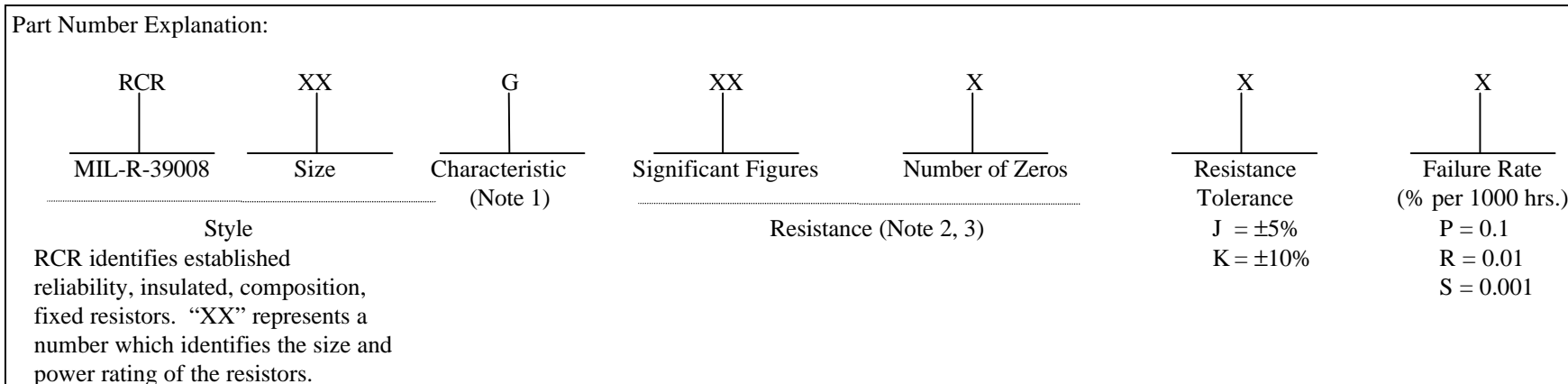

Part Number	Control Specification	Style Size (Note 4)	Characteristics				Maximum Voltage (Vdc)	FRL	
			Rated Power at +70°C (Watts)	Resistance (Ohms)		Tolerance (±%)		Grade 1	Grade 2
				Range					
				Min	Max				
RCR05GXXXXXX	MIL-R-39008/4	RCR05	1/8	2.7			150		
RCR07GXXXXXX	MIL-R-39008/1	RCR07	1/4	2.7			250		
RCR20GXXXXXX	MIL-R-39008/2	RCR20	1/2	1.0	22.0M	5, 10	350	S	P or R
RCR32GXXXXXX	MIL-R-39008/3	RCR32	1.0	1.0			500		
RCR42GXXXXXX	MIL-R-39008/5	RCR42	2.0	10.0			500		

See notes on page 07-9.

MIL-R-39008 Resistors (Page 2 of 2)
Fixed, Composition (Insulated), Established Reliability

Notes:

1. Only characteristic G is available.
2. The nominal resistance value expressed in ohms is identified by a 3 digit number. The first two digits represent significant figures, the last digit specifies the number of following zeros. For resistance values less than 10Ω , substitute the letter "R" for one of the significant digits to represent the decimal point.
CAUTION: Resistance values can change up to 15 percent because of moisture absorption. See (Note 4).
- 3.. Select a standard resistance value for the 10 to 100 decade from the sequence demonstrated in accordance with MS9017 (see Note 2 on page 07-1).
4. Carbon composition resistors are inherently susceptible to moisture absorption. If resistance measurements indicate they are not within tolerance, bake at $+100^{\circ}\text{C}$ (with no power applied) according to the following schedule: style RCR05, 25 ± 4 hours; style RCR42, 130 ± 4 hours; all other styles, 96 ± 4 hours.

MIL-R-39009 Resistors (Page 1 of 2)
Fixed, Wirewound (Power Type, Chassis Mounted), Established Reliability

Part Number Explanation:

RER	XX	X	XXX	X	X
MIL-R-39009	Size	Resistance Tolerance	Significant Figures	Number of Zeros	Failure Rate (% per 1000 hrs.)
Style		F = ±1.0%	Resistance (Notes 1, 2)		P = 0.1 R = 0.01

RER identifies established reliability, chassis mounted, power-type, wirewound, fixed resistors.
 "XX" represents a number which identifies the size and power rating of the resistors.

Part Number	Control Specification	Style Size	Characteristics				FRL	
			(Note 3) Rated Power at +25°C (Watts)	Resistance (Ohms)		Tolerance (±%)		
				Range (Note 4)				
				Minimum	Maximum			
RER60FXXXXX RER65FXXXXX RER70FXXXXX RER75FXXXXX	MIL-R-39009/1 (inductive)	RER60 RER65 RER70 RER75	5.0 10.0 20.0 30.0	0.10	3.32K 5.62K 12.1K 39.2K	1.0	R	P
RER40FXXXXX RER45FXXXXX RER50FXXXXX RER55FXXXXX	MIL-R-39009/2 (noninductive)	RER40 RER45 RER50 RER55	5.0 10.0 20.0 30.0	1.0	1.65K 2.80K 6.04K 4.99K			

See notes on page 07-11.

MIL-R-39009 Resistors (Page 2 of 2)

Fixed, Wirewound (Power Type, Chassis Mounted), Established Reliability

Notes:

1. For $R \geq 100\Omega$, the first three digits are significant figures, the fourth is the number of following zeros. For $R < 100\Omega$, the letter R replaces one of the digits and is used as a decimal point; the remaining digits are significant figures.
2. Select a standard resistance value for the 10 to 100 decade from Table II in MIL-R-39009 (see Note 2 on page 07-1).
3. These aluminum-housed, chassis-mounted styles are assigned power ratings when mounted on test chassis areas of a specific size at an ambient temperature of 25°C. Reference MIL-HDBK-978, Vol. 1, 3. 7.
4. The maximum resistance value of preferred wirewound resistors is constrained by the size of the wire used in their construction. GSFC prohibits the use of wire smaller than 0.001 inch (0.03 mm) in nominal diameter. Consult the applicable detail specification for wire size information.

MIL-R-39015 Resistors (Note 1)
Variable, Wirewound (Lead Screw Actuated), Established Reliability

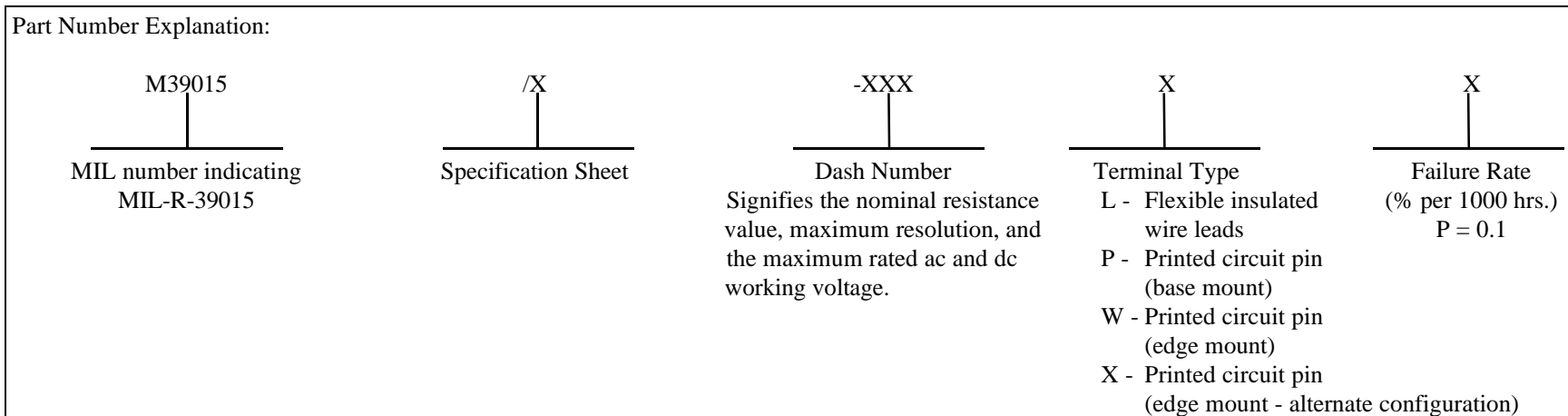

Part Number	Control Specification	Style Size	Characteristics								
			Rated Power at +85°C (Watts)	Resistance (Ohms)		Maximum Resolution Range (%)		Maximum Rated Voltage Range (Volts)		FRL (Note 3)	
				Tolerance (±%)	Range (Note 2)		Min	Max	Min	Max	Grade 2
					Min	Max					
M39015/2-XXXXX	MIL-R-39015/2	RTR22	0.75	5.0	100	10K	0.14	0.51	8.7	86.7	P
M39015/3-XXXXX	MIL-R-39015/3	RTR24	0.75	5.0	10	5K	0.25	1.3	2.7	61.3	P

Notes:

1. Parts covered by this specification may contain internal soldered connections that may reflow during installation. Special care must be exercised when soldering to prevent internal solder reflow. Welded connections are recommended for space flight use. Consult the manufacturer for construction details.
2. The maximum resistance value of preferred wirewound resistors is constrained by the size of the wire used in their construction. GSFC prohibits the use of wire smaller than 0.001 inch (0.03 mm) in nominal diameter. Consult the applicable detail specification for wire size information.
3. Variable resistors shall not be used for Grade 1 applications.

MIL-R-39017 Resistors
Fixed, Film (Insulated), Established Reliability

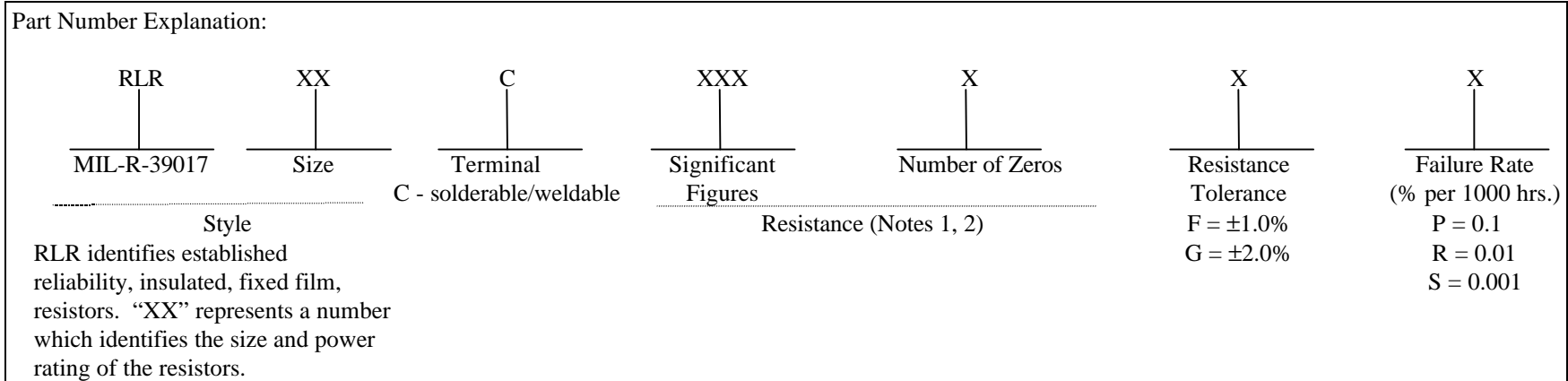

Part Number	Control Specification	Style Size (Note 4)	Characteristics				Maximum Voltage (Vdc)	FRL	
			Rated Power at +70°C (Watts)	Resistance (Ohms)		Tolerance (±%)		Grade 1	Grade 2
				Range (Note 3)					
				Min	Max				
RLR05CXXXXXX	MIL-R-39017/5	RLR05	1/8	4.7	1.0M	1.0, 2.0	200	S	P or R
RLR07CXXXXXX	MIL-R-39017/1	RLR07	1/4	10.0	10.0M				
RLR20CXXXXXX	MIL-R-39017/2	RLR20	1/2	4.3	3.01M				
RLR32CXXXXXX	MIL-R-39017/3	RLR32	1	10.0	1.0M				

Notes:

1. For $R \geq 100\Omega$, the first three digits are significant figures, the fourth is the number of following zeros. For $R < 100\Omega$, the letter R replaces one of the digits and is used as a decimal point; the remaining digits are significant figures.
2. Select a standard resistance value for the 10 to 100 decade from Table V in MIL-R-39017 (see Note 2 on page 07-1).
3. The maximum resistance value presently available for resistors procured to FRL "S" is currently limited as follows:
 RLR05 = .301M maximum; RLR 07 = 3.01M maximum.

MIL-R-55182 Resistors (Page 1 of 3)
Fixed, Film, Established Reliability

Part Number Explanation:

RNX	XX	X	XXX(XX)	X	X	X
MIL-R-55182	Size	Characteristic	Significant Figures	Number of Zeros	Resistance Tolerance	Failure Rate (% per 1000 hrs.)
Style			Resistance (Notes 1, 2)			
RNX identifies established reliability, film, fixed resistors where:		C = Hermetic (± 50 ppm/ $^{\circ}$ C) E = Hermetic (± 25 ppm/ $^{\circ}$ C) H = Nonhermetic (± 50 ppm/ $^{\circ}$ C) J = Nonhermetic (± 25 ppm/ $^{\circ}$ C) K = Nonhermetic (± 100 ppm/ $^{\circ}$ C) Y = Nonhermetic (Note 3) (± 5 ppm/ $^{\circ}$ C, up to $+125^{\circ}$ C) (± 10 ppm/ $^{\circ}$ C, $+125^{\circ}$ C to $+175^{\circ}$ C)			V = $\pm 0.005\%$ T = $\pm 0.01\%$ A = $\pm 0.05\%$ B = $\pm 0.1\%$ D = $\pm 0.5\%$ F = $\pm 1.0\%$	P = 0.1 R = 0.01 S = 0.001

Part Number	Control Specification	Style Size (Note 4)	Rated Power at $+125^{\circ}$ C (Watts)	Characteristics	Resistance (Ohms)			Max. Volts (Vdc)	FRL	
					Range		Tolerance (Note 4)		Grade 1	Grade 2
					Min	Max				
RNC50XXXXXXXX (Note 5)	MIL-R-55182/7	RNC50	0.05	H, J	10	796K	B, D, F	200	S	P or R
				K	10	796K	D, F			
RNN50XXXXXXXX	MIL-R-55182/7	RNN50	0.05	H, J, K	10	301K	F			
RNR50XXXXXXXX	MIL-R-55182/7	RNR50	0.05	H, J	10	796K	B, D, F			
				K	10	796K	D, F			
RNC55XXXXXXXX (Note 5)	MIL-R-55182/1	RNC55	0.1	C, E	200	100K	B, D, F			
				H, J	10	2M	B, D, F			
				K	10	2M	D, F			
RNN55XXXXXXXX	MIL-R-55182/1	RNN55	0.1	C, E	10	301K	B, D, F			
				H, J	10	1M	B, D, F			
				K	10	1M	D, F			
				H, J, K	1M	2M	F			

See notes on page 07-16.

MIL-R-55182 Resistors (Page 2 of 3)
Fixed, Film, Established Reliability

Part Number	Control Specification	Style Size (Note 4)	Rated Power at +125°C (Watts)	Characteristics	Resistance (Ohms)			Max. Volts (Vdc)	FRL	
					Range		Tolerance (Note 4)		Grade 1	Grade 2
					Min	Max				
RNR55XXXXXXXX	MIL-R-55182/1	RNR55	0.1	C, E	10	301K	B, D, F	200	S	P or R
				H, J	10	2M	B, D, F			
				K	10	2M	D, F			
RNC60XXXXXXXX (Note 5)	MIL-R-55182/3	RNC60	0.125	C, E	200	200K	B, D, F	250	S	P or R
				H, J	10	2M	B, D, F			
				K	10	2M	D, F			
				H, J, K	2M	3.01M	F			
RNN60XXXXXXXX	MIL-R-55182/3	RNN60	0.125	C, E	10	301K	B, D, F	250	S	P or R
				H, J	10	2M	B, D, F			
				K	10	2M	D, F			
				H, J, K	2M	3.01M	F			
RNR60XXXXXXXX	MIL-R-55182/3	RNR60	0.125	C, E	10	301K	B, D, F	250	S	P or R
				H, J	10	2M	B, D, F			
				K	10	2M	D, F			
				H, J, K	2M	3.01M	F			
RNC65XXXXXXXX (Note 5)	MIL-R-55182/5	RNC65	0.25	C, E, H, J, K	200	499K	B, D, F	300	S	Note 6
				H, J	10	200	B, D, F			
				H, J	499K	3.01M	B, D, F			
RNN65XXXXXXXX	MIL-R-55182/5	RNN65	0.25	C, E, H, J, K	200	499K	B, D, F	300	S	

See notes on page 07-16.

MIL-R-55182 Resistors (Page 3 of 3)
Fixed, Film, Established Reliability

Part Number	Control Specification	Style Size (Note 4)	Rated Power at +125°C (Watts)	Characteristics	Resistance (Ohms)			Max. Volts (Vdc)	FRL	
					Range		Tolerance (Note 4)		Grade 1	Grade 2
					Min	Max				
RNR65XXXXXXXX	MIL-R-55182/5	RNR65	0.25	C, E, H, J, K	200	499K	B, D, F	300	S	P or R
				H, J	10	200	B, D, F		(Note 6)	
				H, J	499K	3.01M	B, D, F			
RNC70XXXXXXXX (Note 5)	MIL-R-55182/6	RNC70	0.5	C, E	200	250K	B, D, F	350	S	
				H, J, K	200	250K	B, D, F			
RNN70XXXXXXXX	MIL-R-55182/6	RNN70	0.5	C, E	200	250K	B, D, F	350	S	
				H, J, K	200	250K	B, D, F			
RNR70XXXXXXXX	MIL-R-55182/6	RNR70	0.5	C, E	200	250K	B, D, F	350	S	
				H, J, K	200	250K	B, D, F			
RNC90XXXXXXXX	MIL-R-55182/9	RNC90	0.3	Y	4.99	16.0	B, D, F	300	(Note 6)	
					16.2	30.0	A, B, D, F			
					30.1	49.9K	V, T, A, B, D, F			

Notes:

1. All styles except RNC90 are expressed by four digits; for $R \geq 100\Omega$, the first three digits are significant figures, the fourth is the number of following zeros. For $R < 100\Omega$, the letter R replaces one of the digits and represents a decimal point. Style RNC90 is expressed as five significant digits and a letter. For $R < 1000\Omega$, the letter R is used as a decimal point. For values $> 1000\Omega$ but $< 1.0\text{ M}\Omega$, the letter K is used to represent a decimal point and multiplier. All digits preceding and following the letter (R or K) of the group represent significant figures.
2. Select a standard resistance value for the 10 to 100 decade from Table IV in MIL-R-55182 (see Note 2 on page 07-1).
3. Characteristic "Y" is only available in RNC90 style.
4. All styles except RNC90 are electrostatic sensitive. For tolerance B ($\pm 0.1\%$), package in accordance with MIL-R-39032 as specified for field protection.
5. GSFC does not consider type "C" terminal material to be readily weldable and recommends using type "N" material for welding. Types "C" and "R" may be used for soldering. Style RNC90 is not available with "N" terminal material.
6. Grade 1 parts currently are not available (see Note 1 on page 07-1).

MIL-R-55342 RESISTORS (Page 1 of 2)
Fixed, Film, Chip, Established Reliability

Part Number Explanation:

<p>M55342</p> <hr style="width: 80%; margin: 0 auto;"/> <p>MIL number indicating MIL-R-55342 (Note 1)</p>	<p>X</p> <hr style="width: 80%; margin: 0 auto;"/> <p>Characteristic E = ±25ppm/°C H = ±50ppm/°C K = ±100 ppm/°C M = ±300 ppm/°C</p>	<p>XX</p> <hr style="width: 80%; margin: 0 auto;"/> <p>Specification Sheet Number</p>	<p>X</p> <hr style="width: 80%; margin: 0 auto;"/> <p>Termination Material B - Solderable, base metalization barrier metal, solder coated C - Bondable, palladium silver R - Solderable, pretinned W - Bondable, gold</p>	<p>XXXX</p> <hr style="width: 80%; margin: 0 auto;"/> <p>Resistance Value and Tolerance (Notes 2, 3)</p> <table border="1" style="font-size: small; border-collapse: collapse; width: 100%;"> <thead> <tr> <th>Tol.</th> <th>Multiplier</th> <th>Symbol</th> </tr> </thead> <tbody> <tr><td>0.1</td><td>X 1</td><td>A</td></tr> <tr><td>0.1</td><td>X 1,000</td><td>B</td></tr> <tr><td>0.1</td><td>X1,000,000</td><td>C</td></tr> <tr><td>1.0</td><td>X 1</td><td>D</td></tr> <tr><td>1.0</td><td>X 1,000</td><td>E</td></tr> <tr><td>1.0</td><td>X 1,000,000</td><td>F</td></tr> <tr><td>2.0</td><td>X 1</td><td>G</td></tr> <tr><td>2.0</td><td>X 1,000</td><td>H</td></tr> <tr><td>2.0</td><td>X 1,000,000</td><td>T</td></tr> <tr><td>5.0</td><td>X 1</td><td>J</td></tr> <tr><td>5.0</td><td>X 1,000</td><td>K</td></tr> <tr><td>5.0</td><td>X 1,000,000</td><td>L</td></tr> <tr><td>10.0</td><td>X 1</td><td>M</td></tr> <tr><td>10.0</td><td>X 1,000</td><td>N</td></tr> <tr><td>10.0</td><td>X 1,000,000</td><td>P</td></tr> </tbody> </table>	Tol.	Multiplier	Symbol	0.1	X 1	A	0.1	X 1,000	B	0.1	X1,000,000	C	1.0	X 1	D	1.0	X 1,000	E	1.0	X 1,000,000	F	2.0	X 1	G	2.0	X 1,000	H	2.0	X 1,000,000	T	5.0	X 1	J	5.0	X 1,000	K	5.0	X 1,000,000	L	10.0	X 1	M	10.0	X 1,000	N	10.0	X 1,000,000	P	<p>X</p> <hr style="width: 80%; margin: 0 auto;"/> <p>Failure Rate (% per 1000 hrs.) P = 0.1 R = 0.01 S = 0.001</p>
Tol.	Multiplier	Symbol																																																			
0.1	X 1	A																																																			
0.1	X 1,000	B																																																			
0.1	X1,000,000	C																																																			
1.0	X 1	D																																																			
1.0	X 1,000	E																																																			
1.0	X 1,000,000	F																																																			
2.0	X 1	G																																																			
2.0	X 1,000	H																																																			
2.0	X 1,000,000	T																																																			
5.0	X 1	J																																																			
5.0	X 1,000	K																																																			
5.0	X 1,000,000	L																																																			
10.0	X 1	M																																																			
10.0	X 1,000	N																																																			
10.0	X 1,000,000	P																																																			

MIL Sheet	Style	Characteristics	Resistance Range (Ohms)	Tolerance (±%)	Terminations		Volt. Rating (V)	Power Rating (mW)	FRL	
					One Surface	Wrap-around			Grade 1	Grade 2
55342/2	RM0505	E, H	100.0 - 0.200M	0.1	S, W	B, R	40	25	(Note 4)	P
		K, M	5.6 - 0.470M	1.0, 2.0, 5.0, 10.0	W	B, C, R, U	40	50	S	P
M55342/3	RM1005	E, H	100.0 - 0.298M	0.1	S, W	B, R	40	50	(Note 4)	P
		K, M	5.6 - 1.000M	1.0, 2.0, 5.0, 10.0	W	B, C, R, U	40	100	S	P
55342/4	RM1505	E, H	100.0 - 0.499M	0.1	S, W	B, R	40	150	(Note 4)	P
		K	5.6 - 2.000M	1.0, 2.0, 5.0, 10.0	W	B, C, R, U				
		M	5.6 - 4.700M	1.0, 2.0, 5.0, 10.0	W	B, C, R, U				

See notes on page 07-18.

MIL-R-55342 RESISTORS (Page 2 of 2)
Fixed, Film, Chip, Established Reliability

MIL Sheet	Style	Characteristics	Resistance Range (Ohms)	Tolerance ($\pm\%$)	Terminations		Volt. Rating (V)	Power Rating (mW)	FRL	
					One Surface	Wrap-around			Grade 1	Grade 2
55342/5	RM2208	E, H	100.0 - 1.000M	0.1	(Note 4)	B, R	40	200	(Note 4)	P
		K	5.6 - 2.000M	1.0, 2.0, 5.0, 10.0	W	B, C, R	40	225	S	P
		M	5.6 - 15.000M	1.0, 2.0, 5.0, 10.0	W	B, C, R				
55342/6	RM0705	E, H	100.0 - 0.298M	0.1	S, W	B, R	40	50	(Note 4)	P
		K, M	5.6 - 1.000M	1.0, 2.0, 5.0, 10.0	W	B, C, R, U	40	100	S	P
55342/7	RM1206	E, H	100.0 - 0.499M	0.1	S	B, R	100	125	(Note 4)	P
		K, M	5.6 - 1.000M	1.0, 2.0, 5.0, 10.0	(Note 4)	B, C, R, U	100	250	S	P
55342/8	RM2010	E, H	100.0 - 1.000M	0.1	(Note 4)	B, R	150	500	(Note 4)	P
		K	5.6 - 2.000M	1.0, 2.0, 5.0, 10.0	(Note 4)	B, C, R	150	800	(Note 4)	P
		M	5.6 - 15.000M	1.0, 2.0, 5.0, 10.0	(Note 4)	B, C, R				
55342/9	RM2512	E, H	100.0 - 1.000M	0.1	(Note 4)	B, R	200	500	(Note 4)	P
		K	5.6 - 2.000M	1.0, 2.0, 5.0, 10.0	(Note 4)	B, C, R	200	1000	S	P
		M	5.6 - 15.000 M	1.0, 2.0, 5.0, 10.0	(Note 4)	B, C, R				
55342/10	RM1010	K	5.6 - 5.600M	1.0, 2.0, 5.0, 10.0	(Note 4)	B, R	40	500	S	P

Notes:

1. MIL-R-55342/7 resistor part numbers begin D55342; all others begin M55342.
2. Nominal Resistance in ohms is identified by four characters consisting of three digits and a letter. All digits, whether preceding or following the letter, are significant. The letter, inserted in a standard resistance value, is used simultaneously as a decimal point, multiplier, and resistance tolerance indicator as shown in the subtable.
3. Select a standard resistance value for the 10 to 100 decade from Table V in MIL-R-55342 (see Note 2 on page 07-1).
4. Grade 1 part is not available.

MIL-R-83401 Resistors (Notes 1, 2) (Page 1 of 2)
Networks, Fixed, Film

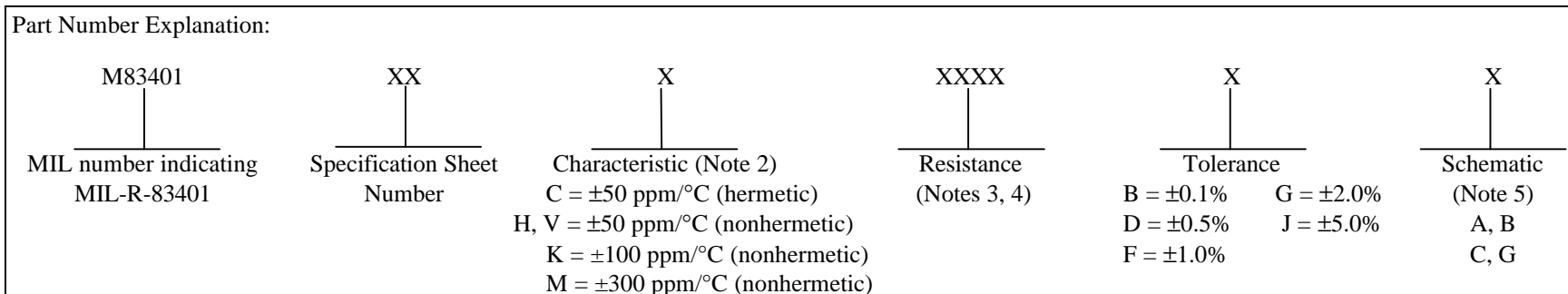

Part Number (Note 6)	Control Specification	Style	Pins/ Package	Charac- teristic	Schematic	Resistance (Ohms)		Tolerance	Max. Voltage/ Element (Vdc)	Rated Power Range at +25°C (Watts) (Note 7)	
						Range				Element	Network
						Min	Max				
M8340101XXXXXXXX	MIL-R-83401/1	RZ010	14/DIP	C, V	A	100	10K	B, D, F, G, J	100	0.05-0.2	0.65-1.4
				H	A	50	100K	B, D, F, G, J			
				H	B	50	70K	B, D, F, G, J			
				K	A, B	27.4	50	F, G, J			
				M	A, B	10	50	F, G, J			
				K,	A, B	50	100K	B, D, F, G, J			
				M	A, B	50	70K	B, D, F, G, J			
				K	A, B	100K	1M	F, G, J			
M	A, B	70K	1M	F, G, J							
M8340102XXXXXXXX	MIL-R-83401/2	RZ020	16/DIP	C, V	A	100	10K	B, D, F, G, J	100	0.05-0.2	0.75-1.6
				H	A	50	100K	B, D, F, G, J			
				H	B	50	70K	B, D, F, G, J			
				K	A, B	27.4	50	F, G, J			
				M	A, B	10	50	F, G, J			
				K,	A, B	50	100K	B, D, F, G, J			
				M	A, B	50	70K	B, D, F, G, J			
				K	A, B	100K	1M	F, G, J			
M	A, B	70K	1M	F, G, J							

See notes on page 07-20.

MIL-R-83401 Resistors (Notes 1, 2) (Page 2 of 2)
Networks, Fixed, Film

Part Number (Note 6)	Control Specification	Style	Pins/ Package	Charac- teristic	Schematic	Resistance (Ohms)		Max. Voltage/ Element (Vdc)	Rated Power Range at +25°C (Watts) (Note 7)		
						Range			Tolerance	Element	Network
						Min	Max				
M8340103XXXXXXXX	MIL-R-83401/3	RZ030	14/ FLAT	H	A, B	150	51.1K	D	50	0.025- 0.05	0.325- 0.35
				H	A, B	150	121K	F, G, J			
				K	A, B	150	51.1K	D			
				K	A, B	150	121K	F, G, J			
				M	A,B	100	51.1K	D			
				K, M	A, B	10	1M	F, G, J			
M8340107XXXXXX	MIL-R-83401/7	RZ070	6/SIP	H	C, G	100	100K	B, D, F, G, J	50	0.12	0.36-0.6
				K, M	C, G	100	100K	B, D			
				K, M	C, G	10	1M	F, G, J			
M8340108XXXXXX	MIL-R-83401/8	RZ080	8/SIP	H	C, G	100	100K	B, D, F, G, J	50	0.12	0.48-0.84
				K, M	C, G	100	100K	B, D			
				K, M	C, G	10	1M	F, G, J			
M8340109XXXXXX	MIL-R-83401/9	RZ090	10/SIP	H	C, G	100	100K	B, D, F, G, J	50	0.12	0.60-1.08
				K, M	C, G	100	100K	B, D			
				K, M	C, G	10	1M	F, G, J			

Notes:

1. Parts covered by this specification may contain internal soldered connections that may reflow during installation. Special care must be exercised when soldering to prevent internal solder reflow. Welded connections are recommended for space flight use. Consult the manufacturer for construction details.
2. Parts manufactured with internal solder terminations shall be subjected to additional testing in accordance with Table 07 of Appendix A.
3. For $R \geq 100 \Omega$, the first three digits are significant figures, the fourth is the number of following zeros. For $R < 100 \Omega$, the letter R replaces one of the digits and is used as a decimal point; the remaining digits are significant figures.
4. Select a standard resistance value for the 10 to 100 decade from Table IV in MIL-R-83401 (see Note 2 on page 07-1).
5. See MIL-R-83401 for schematic details.
6. Parts are acceptable for Grade 2 applications.
7. See the applicable detail specification to determine power ratings for characteristic/schematic combinations.

Summary of Preferred Diodes

Description	Refer to Page No.
Power Rectifier	08-2
Shottky Barrier	08-3
Fast Recovery Rectifier	08-3
Switching	08-5
Zener	08-6
Voltage Reference	08-9
High Voltage	08-10
Bi-Directional Transient Suppressor	08-11
Unidirectional Transient Suppressor	08-13
Thyristor (SCRs)	08-17
Current Regulator	08-18
Varactor	08-19
Full Wave Bridge Rectifiers	08-20
Multiple Diode Array	08-21
Light Emitting	08-21
Small Signal	08-22

Diodes

MIL-S-19500 Part Number Explanation:

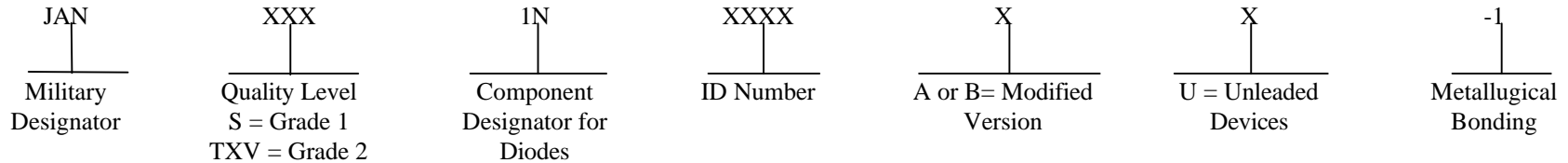

Power Rectifiers (Notes 1, 2)

JAN Part No.	MIL-S-19500	V_{RWM}	I_o	V_{FM} at I_F		I_R at V_{RWM}		t_{rr}	Case
		(Vpk)	(A)	(Vpk)	(A)	25°C	150°C		
1N1202A	/260	200	12	1.35	38	50	1000	—	DO4
1N1186	/297	200	35	1.4	110	—	3000	—	DO5
1N5550*	/420	200	3	1.6	9	1.0	75	2000	DO14
1N1204A	/260	400	12	1.35	38	50	1000	—	DO4
1N1188	/297	400	35	1.4	110	—	3000	—	DO5
1N5551 U *	/420	400	3	1.6	9	1	75	2000	DO14
1N5616 U *	/427	400	1	1.3	3	0.5	25	2000	DO35
1N1206A	/260	600	12	1.35	38	50	1000	—	DO4
1N1190	/297	600	35	1.4	110	—	3000	—	DO5
1N5552 U *	/420	600	3	1.6	9	1	75	2000	DO14
1N5618 U *	/427	600	1	1.3	3	0.5	25	2000	DO35
1N3671A	/260	800	12	1.35	38	50	1000	—	DO4
1N3766	/297	800	35	1.4	110	—	3000	—	DO5
1N5553 U *	/420	800	3	1.6	9	1	75	2000	DO14
1N5620 U	/427	800	1	1.3	3	.5	25	2000	DO35
1N3673A	/260	1000	12	1.35	38	50	1000	—	DO4
1N3768	/297	1000	35	1.4	110	—	3000	—	DO5
1N5554 U *	/420	1000	3	1.6	9	1	75	2000	DO4
1N5622 U	/427	1000	1	1.3	3	0.5	25	2000	DO35
1N4245 thru 1N4249	/286	200 to 1000	1	—	—	—	—	5000	(Note 4)
1N6073 thru 1N6081	/503	50 to 150	3.0 to 12	—	—	—	—	30	

See notes on page 08-22.

Schottky Barrier Rectifiers (Notes 1, 2)

JAN Part No.	MIL-S-19500	I _O (Note 3)	V _R	V _{FM1} at I _{FM}		V _{FM2} at I _{FM}		Case
		(A)	(Vdc)	(Vpk)	(Apk)	(Vpk)	(Apk)	
1N6391	/553	22.5	45	0.68	50	0.48	5	DO-4
1N6392	/554	54	45	0.82	120	0.68	60	DO-5
1N6492	/567	4.5	45	0.68	4	0.56	2	TO39

Fast Recovery Rectifiers (Notes 1, 2) (Page 1 of 2)

JAN Part No.	MIL-S-19500	t _{rr}	V _{RWM}	I _O at 75°C (Note 3)	V _{FM} at I _F		I _R at V _{RWM} (μA dc)		Case
		(ns)	(Vpk)	(A)	(Vpk)	(Apk)	25°C	150°C	
1N3911	/308	15	200	30	1.4	50	15	6000	(Note 4)
1N5804U*	/477	25	100	2.5	0.975	2.5	1	50	
1N5806U*	/477	25	150	2.5	0.975	2.5	1	50	
1N5802*	/479	25	50	2.5	0.975	2.5	1	50	
1N5807*	/477	30	50	6	0.925	6.0	5.0	150	
1N5809*	/477	30	100	6	0.925	6	5	150	
1N5811*	/477	30	150	6	0.925	6	5	150	
1N6620U	/585	30	200	2.0	1.6	2	0.5	150	
1N6621U	/585	30	400	2.0	1.6	2	0.5	150	
1N6622U	/585	30	600	2.0	1.6	2	0.5	150	
1N6626U	/590	30	200	4	1.5	2.5	2	500	
1N6627U	/590	30	400	4	1.5	4	2	500	
1N6628U	/590	30	600	4	1.5	4	2	500	
1N5812	/478	35	50	20	0.86	10	10	75	
1N5814	/478	35	100	20	0.86	10	10	75	
1N5816	/478	35	150	20	0.86	10	10	75	
1N6305	/550	50	100	70	0.975	70	25	3000	
1N6306	/550	50	150	70	0.975	70	25	3000	
1N6623U	/585	50	800	1.5	1.8	2	0.5	150	
1N6629U	/590	50	800	3	1.7	4	2	500	

See notes on page 08-22.

Fast Recovery Rectifiers (Notes 1, 2) (Page 2 of 2)

JAN Part No.	MIL-S-19500	t_{rr}	V_{RWM}	I_O at 75°C (Note 3)	V_{FM} at I_F		I_R at V_{RWM} (μA dc)		Case
		(ns)	(Vpk)	(A)	(Vpk)	(Apk)	25°C	150°C	
1N6625U	/585	60	1000	1.5	1.95	2	1	200	(Note 4)
1N6631U	/590	60	1000	2.5	1.95	3	4	600	
1N4942	/359	150	200	1	—	—	—	—	
1N4944	/359	150	400	1	—	—	—	—	
1N5416*	/411	150	100	3	1.2	9	1	20	
1N5417U*	/411	150	200	3	1.2	9	1	20	
1N5415*	/411	150	200	3	1.2	9	1	20	
1N5418U*	/411	150	400	3	1.2	9	1	20	
1N5615U*	/429	150	200	1	1.6	3	0.5	25	
1N5617U*	/429	150	400	1	1.6	3	0.5	25	
1N3891	/304	200	200	12	1.5	38	15	2000	
1N3893	/304	200	400	12	1.5	38	15	2000	
1N3913	/308	200	400	30	1.4	50	15	6000	
1N4946	/359	250	600	1	—	—	—	—	
1N4947	/359	250	800	1	—	—	—	—	
1N5419U*	/411	250	500	3	1.2	9	1	20	
1N5619U*	/429	250	600	1	1.6	3	0.5	25	
1N5621U*	/429	300	800	1	1.6	3	0.5	25	
1N5623U*	/429	300	1000	1	1.6	3	0.5	25	
1N5420U*	/411	400	600	3	1.2	9	1	20	
1N4948	/359	500	1000	1	—	—	—	—	

See notes on page 08-22.

Switching Diodes (Notes 1, 2)

JAN Part No.	MIL-S-19500	t_{rr}	V_{RWM} (Vpk)	I_R at V_{RWM} (μA)		V_F at I_F		C (pF)	Case
		(ns)		25°C	150°C	(Vdc)	(mA)		
1N5719	/443	—	100	0.25	15	1	100	0.3	(Note 4)
1N5711U	/444	—	50	0.2	200	1	15	2	
1N5712-1	/445	—	16	0.15	100	1	35	2	
1N3595	/241	0.03	125	0.01	3	1	100	8.0	
1N4454-1	/144	4	50	0.1	100	1	10	2	
1N3600	/231	4	50	0.1	100	0.75	10	2.5	
1N4153-1	/337	4	50	0.05	50	0.75	10	2	
1N4153	/337	4	50	0.05	50	0.81	10	2	
1N6638U	/578	4.5	125	0.5	100	1.1	200	2	
1N4148-1	/116	5	75	0.5	100	5	50	4	
1N4531	/116	5	75	0.5	50	1.2	100	4	
1N6642U*	/578	5	75	0.5	100	1.2	100	5	
1N4150-1	/231	6	50	0.1	100	0.74	10	2.5	
1N6643U*	/578	6	50	0.5	160	1.2	100	5	
1N4938-1	/169	50	175	0.1	100	1	100	5	

See notes on page 08-22.

Zener Diodes (Notes 1, 2) (Page 1 of 3)

	JAN Part No. (Listed by Detail Specification and P _T)								
MIL-S-19500	/127	/117	/435	/533	/406	/356	/272	/124	/114
Power (Note 3)	400 mW	400 mW	400 mW	500 mW	1.5 W	5 W	10 W	10 W	50 W
Case	Axial	Axial	Axial	Axial	Axial	Axial	DO4	DO4	TO3
V _Z Nominal (Vdc)									
1.8			1N4614-1						
2.0			1N4615-1						
2.2			1N4616-1						
2.4	1N4370A-1		1N4617-1	1N6309					
2.7	1N4371A-1		1N4618-1	1N6310					
3.0	1N4372A-1		1N4619-1	1N6311					
3.3	1N746A-1		1N4620-1	1N6312	1N6485				
3.6	1N747A-1		1N4621-1	1N6313	1N6486				
3.9	1N748A-1		1N4622-1	1N6314	1N6487		1N3993A		1N4557B
4.3	1N749A-1		1N4623-1	1N6315	1N6488		1N3994A		1N4558B
4.7	1N750A-1		1N4624-1	1N6316	1N6489		1N3995A		1N4559B
5.1	1N751A-1		1N4625-1	1N6317	1N6490		1N3996A		1N4560B
5.6	1N752A-1		1N4626-1	1N6318	1N6491	1N5968	1N3997A		1N4561B
6.2	1N753A-1		1N4627-1	1N6319	1N4460	1N5969	1N3998A		1N4562B
6.8	1N754A-1*		1N4099-1	1N6320*	1N4461	1N4954*	1N3999A	1N2970B	1N2804B
7.5	1N755A-1*		1N4100-1	1N6321*	1N4462	1N4955*	1N4000A	1N2971B	1N2805B
8.2	1N756A-1*		1N4101-1	1N6322*	1N4463	1N4956*		1N2972B	1N2806B
8.7			1N4102-1						
9.1	1N757A-1*		1N4103-1	1N6323*	1N4464	1N4957*		1N2973B	1N2807B
10.0	1N758A-1*		1N4104-1	1N6324*	1N4465	1N4958*		1N2974B	1N2808B
11.0		1N962B-1	1N4105-1	1N6325*	1N4466	1N4959*		1N2975B	1N2809B
12.0	1N759A-1*	1N963B-1	1N4106-1	1N6326*	1N4467	1N4960*		1N2976B	1N2810B
13.0		1N964B-1	1N4107-1	1N6327*	1N4468	1N4961*		1N2977B	1N2811B
14.0			1N4108-1						

See notes on page 08-22.

Zener Diodes (Notes 1, 2) (Page 2 of 3)

	JAN Part No. (Listed by Detail Specification and P _T)								
MIL-S-19500	/127	/117	/435	/533	/406	/356	/272	/124	/114
Power (Note 3)	400 mW	400 mW	400 mW	500 mW	1.5 W	5 W	10 W	10 W	50 W
Case	Axial	Axial	Axial	Axial	Axial	Axial	DO4	DO4	TO3
V _Z Nominal (Vdc)									
15.0		1N965B-1	1N4109-1	1N6328*	1N4469	1N4962*		1N2979B	1N2813B
16.0		1N966B-1	1N4110-1	1N6329*	1N4470	1N4963*		1N2980B	1N2814B
17.0			1N4111-1						
18.0		1N967B-1	1N4112-1	1N6330*	1N4471	1N4964*		1N2982B	1N2816B
19.0			1N4113-1						
20.0		1N968B-1	1N4114-1	1N6331*	1N4472	1N4965*		1N2984B	1N2818B
22.0		1N969B-1	1N4115-1	1N6332*	1N4473	1N4966*		1N2985B	1N2819B
24.0		1N970B-1	1N4116-1	1N6333*	1N4474	1N4967*		1N2986B	1N2820B
25.0			1N4117-1						
27.0		1N971B-1	1N4118-1	1N6334*	1N4475*	1N4968*		1N2988B	1N2822B
28.0			1N4119-1						
30.0		1N972B-1	1N4120-1	1N6335*	1N4476*	1N4969*		1N2989B	1N2823B
33.0		1N973B-1	1N4121-1	1N6336*	1N4477*	1N4970*		1N2990B	1N2824B
36.0		1N974B-1	1N4122-1	1N6337	1N4478*	1N4971*		1N2991B	1N2825B
39.0		1N975B-1	1N4123-1	1N6338	1N4479*	1N4972*		1N2992B	1N2826B
43.0		1N976B-1	1N4124-1	1N6339	1N4480*	1N4973*		1N2993B	1N2827B
47.0		1N977B-1	1N4125-1	1N6340	1N4481*	1N4974*		1N2995B	1N2829B
51.0		1N978B-1	1N4126-1	1N6341	1N4482*	1N4975*		1N2997B	1N2831B
56.0		1N979B-1	1N4127-1	1N6342	1N4483*	1N4976*		1N2999B	1N2832B
60.0			1N4128-1						
62.0		1N980N-1	1N4129-1	1N6343	1N4484*	1N4977*		1N3000B	1N2833B
68.0		1N981B-1	1N4130-1	1N6344	1N4485*	1N4978*		1N3001B	1N2834B
75.0		1N982B-1	1N4131-1	1N6345	1N4486*	1N4979*		1N3002B	1N2835B
82.0		1N983B-1	1N4132-1	1N6346	1N4487*	1N4980*		1N3003B	1N2836B
87.0			1N4133-1						
91.0		1N984B-1	1N4134-1	1N6347	1N4488*	1N4981*		1N3004B	1N2837B
100.0		1N985B-1	1N4135-1	1N6348	1N4489*	1N4982*		1N3005B	1N2838B

See notes on page 08-22.

Zener Diodes (Notes 1, 2) (Page 3 of 3)

	JAN Part No. (Listed by Detail Specification and P_T)								
MIL-S-19500	/127	/117	/435	/533	/406	/356	/272	/124	/114
Power (Note 3)	400 mW	400 mW	400 mW	500 mW	1.5 W	5 W	10 W	10 W	50 W
Case	Axial	Axial	Axial	Axial	Axial	Axial	DO4	DO4	TO3
V_Z Nominal (Vdc)									
110.0		1N986B-1		1N6349	1N4490*	1N4983*		1N3007B	1N2840B
120.0		1N987B-1		1N6350	1N4491*	1N4984*		1N3008B	1N2841B
130.0		1N988B-1		1N6351	1N4492*	1N4985*		1N3009B	1N2842B
150.0		1N989B-1		1N6352	1N4493*	1N4986*		1N3011B	1N2843B
160.0		1N990B-1		1N6353	1N4494*	1N4987*		1N3012B	1N2844B
180.0		1N991B-1		1N6354	1N4495*	1N4988*		1N3014B	1N2845B
200.0		1N992B-1		1N6355	1N4496*	1N4989*		1N3015B	1N2846B
220.0						1N4990*			
240.0						1N4991*			
270.0						1N4992*			
300.0						1N4993*			
330.0						1N4994*			
360.0						1N4995*			
390.0						1N4996*			

See notes on page 08-22.

Voltage Reference Diodes (Notes 1, 2)

JANS Part No.	MIL-S-19500	Reference Voltage V_R		Dynamic Impedance Z at I_Z		Case
		Min	Max	(Ohms)	(mA)	
		(Vdc)	(Vdc)			
1N821-1*	/159	5.89	6.51	15	7.5	DO-7
1N823-1*	/159	5.89	6.51	15	7.5	DO-7
1N825-1*	/159	5.89	6.51	15	7.5	DO-7
1N827-1*	/159	5.89	6.51	15	7.5	DO-7
1N829-1*	/159	5.89	6.51	15	7.5	DO-7
1N4565A-1*	/452	6.08	6.72	200	0.5	DO-7
1N4566A-1*	/452	6.08	6.72	200	0.5	DO-7
1N4567A-1*	/452	6.08	6.72	200	0.5	DO-7
1N4568A-1*	/452	6.08	6.72	200	0.5	DO-7
1N4569A-1*	/452	6.08	6.72	200	0.5	DO-7
1N4570A-1*	/452	6.08	6.72	100	1	DO-7
1N4571A-1*	/452	6.08	6.72	100	1	DO-7
1N4572A-1*	/452	6.08	6.72	100	1	DO-7
1N4573A-1*	/452	6.08	6.72	100	1	DO-7
1N4574A-1*	/452	6.08	6.72	100	1	DO-7
1N3154-1	/158	7.98	8.82	15	10	DO-7
1N3155-1	/158	7.98	8.82	15	10	DO-7
1N3156-1	/158	7.98	8.82	15	10	DO-7
1N3157-1	/158	7.98	8.82	15	10	DO-7
1N935B-1	/156	8.55	9.45	20	7.5	DO-7
1N937B-1	/156	8.55	9.45	20	7.5	DO-7
1N938B-1	/156	8.55	9.45	20	7.5	DO-7
1N939B-1	/156	8.55	9.45	20	7.5	DO-7
1N940B-1	/156	8.55	9.45	20	7.5	DO-7
1N941B-1	/157	11.12	12.28	30	7.5	DO-7
1N943B-1	/157	11.12	12.28	30	7.5	DO-7
1N944B-1	/157	11.12	12.28	30	7.5	DO-7
1N945B-1	/157	11.12	12.28	30	7.5	DO-7

See notes on page 08-22.

High Voltage Diodes (Notes 1, 2)

JAN Part No.	MIL-S-19500	V_{RWM}	I_O	t_{rr}	V_F At I_O	I_R at V_{RWM}		Case
		(Vdc)	(A)			(ns)	(Vdc)	
1N6520	/576	1,500	0.5	70	3	0.5	150	(Note 4)
1N6528	/577	1,500	0.25	70	3	0.1	50	
1N6521	/576	2,000	0.5	70	3	0.5	150	
1N6529	/577	2,000	0.25	70	3	0.1	50	
1N6522	/576	2,500	0.25	70	5	0.5	150	
1N6530	/577	2,500	0.1	70	7	0.1	50	
1N6523	/576	3,000	0.25	70	5	0.5	150	
1N6531	/577	3,000	0.1	70	7	0.1	50	
1N6524	/576	4,000	0.15	70	7	0.5	150	
1N6532	/577	4,000	0.05	70	9	0.1	50	
1N6525	/576	5,000	0.15	70	7	0.5	150	
1N6533	/577	5,000	0.05	70	9	0.1	50	
1N6526	/576	7,500	0.1	70	12	0.5	150	
1N6534	/577	7,500	0.025	70	14	0.1	50	
1N6527	/576	10,000	0.1	70	12	0.5	150	
1N6535	/577	10,000	0.025	70	14	0.1	50	

See notes on page 08-22.

Bi-Directional Transient Suppressor Diodes (Notes 1, 2) (Page 1 of 2)

JAN Part No.		Breakdown Voltage V_{BR} (Vdc)		Working Peak Voltage $V_{M wkg}$	Maximum Peak Surge Voltage V_{SM}	Maximum Peak Surge Current I_{SM} (A _{pk})		Case
500 W	1500 W	Min	Max	(Vdc)	(Vpk)	500W	1500W	
1N6130A*	1N6139A	7.13	7.87	5.7	11.2	44.6	133.9	(Note 4)
1N6104A*	1N6140A	7.79	8.61	6.2	12.1	41.3	124.0	
1N6105A*	1N6141A	8.65	9.55	6.9	13.4	37.3	111.9	
1N6106A*	1N6142A	9.50	10.50	7.6	14.5	34.5	103.4	
1N6107A*	1N6143A	10.45	11.55	8.4	15.6	32.0	96.2	
1N6108A*	1N6144A	11.40	12.60	9.1	16.9	29.6	88.8	
1N6109A*	1N6145A	12.35	13.65	9.9	18.2	27.5	82.4	
1N6110A*	1N6146A	14.25	15.75	11.4	21.0	23.8	71.4	
1N6111A*	1N6147A	15.20	16.80	12.2	22.3	22.4	67.3	
1N6112A*	1N6148A	17.10	18.90	13.7	25.1	19.9	59.8	
1N6113A*	1N6149A	19.0	21.0	15.2	27.7	18.0	54.2	
1N6114A*	1N6150A	20.9	23.1	16.7	30.5	16.4	49.2	
1N6115A*	1N6151A	22.8	25.2	18.2	33.3	15.0	45.0	
1N6116A*	1N6152A	25.7	28.3	20.6	37.4	13.4	40.1	
1N6117A*	1N6153A	28.5	31.5	22.8	41.6	12.0	36.0	
1N6118A*	1N6154A	31.4	34.6	25.1	45.7	10.9	32.8	
1N6119A	1N6155A	34.2	37.8	27.4	49.9	10.0	30.1	
1N6120A	1N6156A	37.1	40.9	29.7	53.6	9.3	28.0	
1N6121A	1N6157A	40.9	45.1	32.7	59.1	8.5	25.4	
1N6122A	1N6158A	44.7	49.3	35.8	64.6	7.7	23.2	
1N6123A	1N6159A	48.5	53.5	38.8	70.1	7.1	21.4	

See notes on page 08-22.

Bi-Directional Transient Suppressor Diodes (Notes 1, 2) (Page 2 of 2)

JAN Part No.		Breakdown Voltage V_{BR} (Vdc)		Working Peak Voltage VM wkg (Vdc)	Maximum Peak Surge Voltage V_{SM} (Vpk)	Maximum Peak Surge Current I_{SM} (Apk)		Case
500 W	1500 W	Min	Max			500W	1500W	
1N6124A	1N6160A	53.2	58.8	42.6	77.0	6.5	19.5	(Note 4)
1N6125A	1N6161A	58.9	65.1	47.1	85.3	5.9	17.6	
1N6126A	1N6162A	64.6	71.4	51.7	97.1	5.1	15.4	
1N6127A	1N6163A	71.3	78.7	56.0	103.1	4.8	14.5	
1N6128A	1N6164A	77.9	86.1	62.2	112.8	4.4	13.3	
1N6129A	1N6165A	86.5	95.5	69.2	125.1	4.0	12.0	
1N6130A	1N6166A	95.0	105.0	76.0	137.6	3.6	10.9	
1N6131A	1N6167A	104.5	115.5	86.6	151.3	3.3	9.9	
1N6132A	1N6168A	114.0	126.0	91.2	165.1	3.0	9.1	
1N6133A	1N6169A	123.5	136.5	98.8	178.8	2.8	8.4	
1N6134A	1N6170A	142.5	137.5	114.0	206.3	2.4	7.3	
1N6135A	1N6171A	152	168	121.6	218.4	2.3	6.9	
1N6136A	1N6172A	171	189	136.8	245.7	2.0	6.1	
1N6137A	1N6173A	190	210	152.0	273.0	1.8	5.5	

See notes on page 08-22.

Unidirectional Transient Suppressor Diodes (Notes 1, 2) (Page 1 of 4)

JAN Part No. MIL-S-19500/434 1500 Watts	Breakdown Voltage $V_{(BR)}$ at $I_{BR(min)}$	Working Peak Reverse Voltage V_{RWM}	Test Current $t_p=300ms$ Duty Cycle ≤ 2 I_{BR}	Maximum Clamping Voltage at I_P for $t_p = 1 ms$ $V_C(max)$	Maximum Peak Pulse Current I_P		Case
					$t_p = 20 \mu s$ $tr = 8 \mu s$	$t_p = 1ms$ $tr = 10 \mu s$	
	(Vdc)	(Vpk)	(mA)	(Vpk)	(Apk)	(Apk)	
1N5610	33.0	30.5	1	47.6	193	32.0	(Note 4)
1N5611	43.7	40.3	1	63.5	136	24.0	
1N5612	54.0	49.0	1	78.5	116	19.0	
1N5613	191.0	175.0	1	265.0	33	5.7	
MIL-S-19500/500 1500 Watts							
1N5555	33.0	30.5	1	47.5	193	32.0	(Note 4)
1N5556	43.7	40.3	1	63.5	136	24.0	
1N5557	54.0	49.0	1	78.5	116	19.0	
1N5558	191.0	175.0	1	265.0	33	5.7	
1N5907	6.0	5.0	1	8.5	1000	150.0	
1N5629A	6.45	5.8	10	10.5	810	143.0	
1N5630A	7.13	6.4	10	11.3	750	132.0	
1N5631A	7.79	7.02	10	12.1	700	124.0	
1N5632A	8.65	7.78	1	13.4	630	112.0	
1N5633A	9.5	8.55	1	14.5	585	103.5	
1N5634A	10.5	9.4	1	15.6	545	96.0	
1N5635A	11.4	10.2	1	16.7	510	90.0	
1N5636A	12.4	11.1	1	18.2	465	82.0	
1N5637A	14.3	12.8	1	21.2	400	71.0	

See notes on page 08-22.

Unidirectional Transient Suppressor Diodes (Notes 1, 2) (Page 2 of 4)

JAN Part No. MIL-S-19500/500 1500 Watts	Breakdown Voltage $V_{(BR)}$ at $I_{BR(min)}$ (Vdc)	Working Peak Reverse Voltage V_{RWM} (Vpk)	Test Current $t_p=300ms$ Duty Cycle ≤ 2 I_{BR} (mA)	Maximum Clamping Voltage at I_P for $t_p = 1 ms$ $V_C(max)$ (Vpk)	Maximum Peak Pulse Current I_P		Case
					$t_p = 20 \mu s$ $t_r = 8 \mu s$ (Apk)	$t_p = 1ms$ $t_r = 10 \mu s$ (Apk)	
1N5638A	15.2	13.6	1	22.5	375	67.0	(Note 4)
1N5639A	17.1	15.3	1	25.2	335	59.5	
1N5640A	19.0	17.1	1	27.7	305	54.0	
1N5641A	20.9	18.8	1	30.6	275	49.0	
1N5642A	22.8	20.5	1	33.2	255	45.0	
1N5643A	25.7	23.1	1	37.5	225	40.0	
1N5644A	28.5	25.6	1	41.4	205	36.0	
1N5645A	31.4	28.2	1	45.7	185	33.0	
1N5646A	34.2	30.8	1	49.9	170	30.0	
1N5647A	37.1	33.3	1	53.9	155	28.0	
1N5648A	40.9	36.8	1	59.3	145	25.3	
1N5649A	44.7	40.2	1	64.8	130	23.2	
1N5650A	48.5	43.6	1	70.1	120	21.4	
1N5651A	53.2	47.8	1	77.0	110	19.5	
1N5652A	58.9	53.0	1	85.0	100	17.7	
1N5653A	64.6	58.1	1	92.0	90	16.3	
1N5654A	71.3	64.1	1	103.0	82	14.6	
1N5655A	77.9	70.1	1	113.0	75	13.3	
1N5656A	86.5	77.8	1	125.0	68	12.0	
1N5657A	95.0	85.5	1	137.0	62	11.0	

See notes on page 08-22.

Unidirectional Transient Suppressor Diodes (Notes 1, 2) (Page 3 of 4)

JAN Part No. MIL-S-19500/500 1500 Watts	Breakdown Voltage $V_{(BR)}$ at $I_{BR}(min)$	Working Peak Reverse Voltage V_{RWM}	Test Current $t_p=300ms$ Duty Cycle ≤ 2 I_{BR}	Maximum Clamping Voltage at I_P for $t_p = 1 ms$ $V_C(max)$	Maximum Peak Pulse Current I_P		Case
					$t_p = 20 \mu s$ $tr = 8 \mu s$	$t_p = 1ms$ $tr = 10 \mu s$	
	(Vdc)	(Vpk)	(mA)	(Vpk)	(Apk)	(Apk)	
1N5658A	105.0	94.0	1	152.0	55	9.9	(Note 4)
1N5659	114.0	102.0	1	165.0	50	9.1	
1N5660	124.0	111.0	1	179.0	47	8.4	
1N5661	143.00	123.0	1	207.0	40	7.2	
1N5662	152.0	136.0	1	219.0	38	6.8	
1N5663	162.0	145.0	1	234.0	36	6.4	
1N5664	171.0	154.0	1	246.0	34	6.1	
1N5665	190.0	171.0	1	274.0	30	5.5	
MIL-S-19500/551 500 Watts							
1N6461	5.6	5	25	9.0	315	56	(Note 4)
1N6462	6.5	6	20	11.0	258	46	
1N6463	13.6	12	5	22.6	125	22	
1N6464	16.4	15	5	26.5	107	19	
1N6465	27	24	2	41.4	69	12	
1N6466	33	30.5	1	47.5	63	11	
1N6467	43.7	40.3	1	63.5	45	8	
1N6468	54	51.6	1	78.5	35	6	

See notes on page 08-22.

Unidirectional Transient Suppressor Diodes (Notes 1, 2) (Page 4 of 4)

JAN Part No. MIL-S-19500/552 1500 Watts	Breakdown Voltage $V_{(BR)}$ at $I_{BR}(\min)$	Working Peak Reverse Voltage V_{RWM}	Test Current $t_p=300ms$ Duty Cycle ≤ 2 I_{BR}	Maximum Clamping Voltage at I_P for $t_p = 1 ms$ $V_C(\max)$	Maximum Peak Pulse Current I_P		Case
					$t_p = 20 \mu s$ $t_r = 8 \mu s$	$t_p = 1ms$ $t_r = 10 \mu s$	
	(Vdc)	(Vpk)	(mA)	(Vpk)	(Apk)	(Apk)	
1N6469	5.6	5	50	9.0	945	167	(Note 4)
1N6470	6.5	6	50	11.0	775	137	
1N6471	13.6	12	10	22.6	374	66	
1N6472	16.4	15	10	26.5	322	57	
1N6473	27	24	50	41.4	206	36.5	
1N6474	33	30.5	1	47.5	190	32	
1N6475	43.7	40.3	1	63.5	136	24	
1N6476	54	51.6	1	78.5	106	19	

See notes on page 08-22.

Thyristors (SCRs) (Notes 1, 2)

JANS Part No.	MIL-S-19500	I _O at T _C		V _{RSM} (Vpk)	I _{FSM} surge (A)	t _{on} (μs)	T _{off} (μs)	V _{GTM} (Vdc)	I _M (mA)	Case
		(A)	°C							
2N3027	/419	0.175	100	30	—	0.2	2	0.6	0.2	TO-18
2N3028	/419	0.175	100	60	—	0.2	2	0.6	0.2	TO-18
2N3029	/419	0.175	100	100	—	0.2	2	0.6	0.2	TO-18
2N2323A	/276	0.22	80	75	15	—	—	1	0.35	TO-5
2N2324A	/276	0.22	80	150	15	—	—	1	0.35	TO-5
2N2326A	/276	0.22	80	300	15	—	—	1	0.35	TO-5
2N2328A	/276	0.22	80	400	15	—	—	1	0.35	TO-5
2N2329	/276	0.22	80	500	15	—	—	1	0.35	TO-5
2N1774A	/168	4.7	105	200	60	5	30	2	30	TO-64
2N1777A	/168	4.7	105	400	60	5	30	2	30	TO-64
2N685	/108	16	65	200	150	5	30	3	80	TO-208MA
2N688	/108	16	65	400	150	5	30	3	80	TO-208MA
2N690	/108	16	65	600	150	5	40	3	80	TO-208MA

See notes on page 08-22.

Current Regulator Diodes (Notes 1, 2)

JAN Part No.	MIL-S-19500	I _P (mA)	Z _S (MΩ)	Z _K (kΩ)	V _L (Vdc)	Temperature Coefficient of I _S T _{CIP} (%/°C)				Case
						at -55°C		at -25°C		
						Min	Max	Min	Max	
1N5283	/463	0.22	25	2750	1	0.20	+1.35	-0.16	+0.70	DO-7
1N5284	/463	0.24	19	2350	1	—	+1.25	-0.11	+0.66	DO-7
1N5285	/463	0.27	14	1950	1	-0.10	+1.15	-0.12	+0.58	DO-7
1N5286	/463	0.30	9	1600	1	-0.15	+1.05	-0.15	+0.52	DO-7
1N5287	/463	0.33	6.6	1350	1	-0.20	+0.95	-0.16	+0.47	DO-7
1N5288	/463	0.39	4.1	1000	1.05	-0.30	+0.82	-0.20	+0.38	DO-7
1N5289	/463	0.43	3.3	870	1.05	-0.32	+0.75	-0.22	+0.33	DO-7
1N5290	/463	0.47	2.7	750	1.05	-0.35	+0.70	-0.23	+0.28	DO-7
1N5291	/463	0.56	1.9	560	1.10	-0.40	+0.55	-0.26	+0.20	DO-7
1N5292	/463	0.62	1.55	470	1.13	-0.42	+0.45	-0.27	+0.15	DO-7
1N5293	/463	0.68	1.35	400	1.15	-0.45	+0.40	-0.28	+0.12	DO-7
1N5294	/463	0.75	1.15	335	1.20	-0.50	+0.35	-0.30	+0.07	DO-7
1N5295	/463	0.82	1.00	290	1.25	-0.52	+0.27	-0.31	+0.03	DO-7
1N5296	/463	0.91	0.88	240	1.29	-0.56	+0.20	-0.32	—	DO-7
1N5297	/463	1.00	0.80	205	1.35	-0.58	+0.15	-0.34	—	DO-7
1N5298	/463	1.10	0.70	180	1.40	-0.60	+0.10	-0.36	—	DO-7
1N5299	/463	1.20	0.64	155	1.45	-0.63	+0.05	-0.37	—	DO-7
1N5300	/463	1.30	0.58	135	1.50	-0.65	—	-0.38	—	DO-7
1N5301	/463	1.40	0.54	115	1.55	-0.68	—	-0.39	—	DO-7
1N5302	/463	1.50	0.51	105	1.60	-0.70	—	-0.40	—	DO-7
1N5303	/463	1.60	0.475	92	1.65	-0.70	—	-0.40	—	DO-7
1N5304	/463	1.80	0.42	74	1.75	-0.72	—	-0.41	—	DO-7
1N5305	/463	2.00	0.395	61	1.85	-0.75	—	-0.42	—	DO-7
1N5306	/463	2.20	0.37	52	1.95	-0.76	—	-0.42	—	DO-7
1N5307	/463	2.40	0.345	44	2.00	-0.78	—	-0.43	—	DO-7
1N5308	/463	2.7	0.32	35	2.15	-0.80	—	-0.43	—	DO-7
1N5309	/463	3.0	0.30	29	2.25	-0.81	—	-0.43	—	DO-7
1N5310	/463	3.3	0.28	24	2.35	-0.82	—	-0.44	—	DO-7
1N5311	/463	3.6	0.265	20	2.5	-0.83	—	-0.44	—	DO-7
1N5312	/463	3.9	0.255	17	2.6	-0.84	—	-0.45	—	DO-7
1N5313	/463	4.3	0.245	14	2.75	-0.85	—	-0.45	—	DO-7
1N5314	/463	4.7	0.236	12	2.9	-0.86	—	-0.45	—	DO-7

See notes on page 08-22.

Varactor Diodes (Notes 1, 2)

JAN Part No.	MIL-S-19500	Ct at 4 Vdc (pF)	Capacitance Ratio (min.) Ct ₁ @V _{R1} , Ct ₂ @ V _{R2}			Voltage V _{RWM} (Vdc)	Figure of Merit (Q) at V _R = 4 Vdc		Case
			$\left(\frac{ct_1}{ct_2}\right)$	V _{R1} (Vdc)	V _{R2} (Vdc)		Q	Freq (MHz)	
1N5139A	/383	6.8	2.7	4	60	60	350	1	DO-7
1N5461C	/436	6.8	2.9	2	30	—	600	50	DO-7
1N5462C	/436	8.2	2.95	2	30	—	600	50	DO-7
1N5140A	/383	10	2.8	4	60	60	300	1	DO-7
1N5463C	/436	10	2.95	2	30	—	550	50	DO-7
1N5141A	/383	12	2.8	4	60	60	300	1	DO-7
1N5464C	/436	12	2.95	2	30	—	550	50	DO-7
1N5142A	/383	15	2.8	4	60	60	250	1	DO-7
1N5465C	/436	15	2.95	2	30	—	550	50	DO-7
1N5143A	/383	18	2.8	4	60	60	250	1	DO-7
1N5466C	/436	18	3	2	30	—	500	50	DO-7
1N5467C	/436	20	3	2	30	—	500	50	DO-7
1N5468C	/436	22	3.05	2	30	—	500	50	DO-7
1N5144A	/383	22	3.2	4	60	60	200	1	DO-7
1N5469C	/436	27	3.05	2	30	—	500	50	DO-7
1N5145A	/383	27	3.2	4	60	60	200	1	DO-7
1N5470C	/436	33	3.05	2	30	—	500	50	DO-7
1N5146A	/383	33	3.2	4	60	60	200	1	DO-7
1N5471C	/436	39	3.05	2	30	—	500	50	DO-7
1N5147A	/383	39	3.2	4	60	60	200	1	DO-7
1N5472C	/436	47	3.05	2	30	—	400	50	DO-7
1N5148A	/383	47	3.2	4	60	60	200	1	DO-7
1N5473C	/436	56	3.1	2	30	—	300	50	DO-7
1N5473C	/436	68	3.1	2	30	—	250	50	DO-7
1N5475C	/436	82	3.1	2	30	—	225	50	DO-7
1N5476C	/436	100	3.1	2	30	—	200	50	DO-7

See notes on page 08-22.

Full Wave Bridge Rectifiers (Notes 1, 2)

JAN Part No.	MIL-S-19500	I_o	I_{FSM}	I_R at V_R		Phase	Case
		(Note 3)		(μA)	(Vdc)		
		(A)	(A)				
M19500/469-01	/469	10	100	2	200	Single	(Note 4)
M19500/469-02	/469	10	100	2	400	Single	
M19500/469-03	/469	10	100	2	600	Single	
M19500/469-04	/469	10	100	2	800	Single	
M19500/469-05	/469	10	100	2	1000	Single	
SPA25	/446	25	150	2	100	Single	
SPB25	/446	25	150	2	200	Single	
SPC25	/446	25	150	2	400	Single	
SPD25	/446	25	150	2	600	Single	
M19500/483-01	/483	25	150	2	200	Three	
M19500/483-02	/483	25	150	2	400	Three	
M19500/483-03	/483	25	150	2	600	Three	

See notes on page 08-22.

Multiple Diode Arrays (Notes 1, 2)

JAN Part No.	MIL-S-19500	I_o	V_F at I_F		I_R at V_R		T_{rr} (ns)	C_T (pF)	Case
		(mA)	(Vdc)	(mA)	(uA)	(Vdc)			
1N5768	/474	300	1.5	500	0.1	40	20	4	FLAT
1N5770	/474	300	1.5	500	0.1	40	20	8	FLAT
1N5772	/474	300	1.5	500	0.1	40	20	8	FLAT
1N5774	/474	300	1.5	500	0.1	40	20	8	FLAT
1N6506	/474	300	1.5	500	0.1	40	20	4	DIP
1N6507	/474	300	1.5	500	0.1	40	20	8	DIP
1N6508	/474	300	1.5	500	0.1	40	20	8	DIP
1N6509	/474	300	1.5	500	0.1	40	20	8	DIP
1N6100	/474	300	1.0	100	0.025	20	5	4	FLAT
1N6101	/474	300	1.0	100	0.025	20	5	4	DIP
1N6510	/474	300	1.0	100	0.025	20	5	4	FLAT
1N6511	/474	300	1.0	100	0.025	20	5	4	DIP

Light Emitting Diodes (Notes 1, 2)

JAN Part No.	MIL-S-19500	Color	I_V	C at $V_R = 0$ $f = 9$ MHz	V_{FM}	Wave Length (λ) (nm)		Case
			(mcd)	(pF)		(Vdc)	Min	
1N6609	/519	RED	20	100	3	590	695	(Note 4)
1N6610	/520	YELLOW	20	100	3	550	660	
1N6611	/521	GREEN	20	100	3	525	600	
1N6495	/572	GREEN	0.8	100	3	525	580	
1N6493	/572	RED	1	100	3	595	695	
1N6494	/572	YELLOW	1	100	3	570	595	
1N6499	/574	GREEN	0.5	500	25	525	580	
1N6497	/574	RED	0.5	500	20	595	695	
1N6498	/574	YELLOW	0.5	500	20	570	595	

See notes on page 08-22.

Small Signal Diodes (Notes 1, 2)

JAN Part No.	MIL-S-19500	I _o	V _{RWM}	V _{FMI} at I _{FMI}		Case
		(A)		(Vpk)	(Vpk)	
1N645-1*	/240	400	225	1.0	0.4	TO5
1N647-1*	/240	400	400	1.0	0.4	TO5
1N649-1*	/240	400	600	1.0	0.4	TO5

Notes:

1. An asterisk (*) next to the device number indicates that the part is available to both JANS and JANTXV assurance levels. The absence of the asterisk indicates that the part is available only to the JANTXV assurance level.
2. Except for non-cavity diodes, all JANTXV diodes must be PIND tested in accordance with Appendix A and are preferred Grade 2 parts.
3. The average forward current, I_o, is specified at different temperatures, ranging from 25°C to 150°C. The power rating for zener diodes may also be given at different temperatures, ranging from 25°C to 150°C. Refer to detail specifications for exact test conditions.
4. No standard JEDEC case outline is specified. Refer to detail specification for package outline.

Summary of Preferred Transistors

Description	Refer to Page No.
NPN, Low Power	09-2
PNP, Low Power	09-3
NPN, High Power	09-4
PNP, High Power	09-6
RF	09-7
Quad, MOSFETs	09-7
N-Channel Power MOSFETs	09-8
P-Channel Power MOSFETs	09-10
PNP, Darlington	09-10
NPN, Darlington	09-11
N-Channel FETs	09-11
P-Channel FETs	09-12
Silicon Dual, Complementary	09-12
Optocouplers	09-13

Transistors

MIL-S-19500 Part Number Explanation:

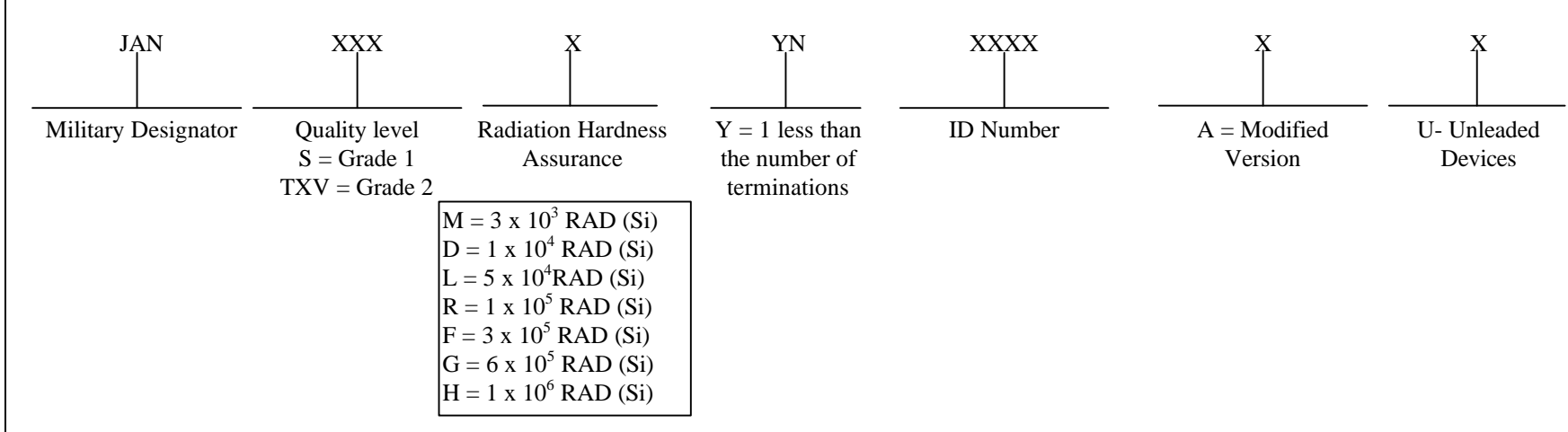

NPN Low Power Transistors (Notes 1, 2) (Page 1 of 2)

JAN Part No.	MIL-S-19500	Maximum Ratings					Primary Electrical Characteristics					Case
		P_T $T_A=25^\circ\text{C}$	I_C	V_{CBO}	V_{CEO}	V_{EBO}	h_{FE} at I_C		$V_{CE(sat)}$ at I_C		C_{obo}	
		(mW)	(mA)	(Vdc)	(Vdc)	(Vdc)	Min/Max	(mA)	(Vdc)	(mA)	(pF)	
2N2484*	/376	360	50	60	60	6.0	200/500	0.01	0.3	1.0	5.0	TO18
2N2222AU* (Note 3)	/255	500	800	75	50	6.0	100/300	150	1.0	500	8.0	TO18
2N3440*	/368	800	1000	300	250	7.0	40/160	20	0.5	50	10	TO5
2N3439*	/368	800	1000	450	350	7.0	40/160	20	0.5	50	10	TO5
2N3507	/349	1000	3000	80	50	5.0	30/150	1500	1.0	1500	40	TO5
2N3421*	/393	1000	3000	125	80	8.0	40/120	1000	0.25	1000	150	TO5
2N3418	/393	1000	3000	80	60	8.0	20/60	1000	0.25	1000	150	TO5
2N3419	/393	1000	3000	80	80	8.0	20/60	1000	0.25	1000	150	TO5
2N3420	/393	1000	3000	80	60	8.0	40/20	1000	0.25	1000	150	TO5

See notes on page 09-13.

NPN Low Power Transistors (Notes 1, 2) (Page 2 of 2)

JAN Part No.	MIL-S-19500	Maximum Ratings					Primary Electrical Characteristics					Case
		P_T $T_A=25^\circ\text{C}$	I_C	V_{CBO}	V_{CEO}	V_{EBO}	h_{FE} at I_C		$V_{CE(sat)}$ at I_C		C_{obo}	
		(mW)	(mA)	(Vdc)	(Vdc)	(Vdc)	Min/Max	(mA)	(Vdc)	(mA)	(pF)	
2N5339	/560	1000	5000	100	100	6.0	60/240	2000	0.7	2000	250	TO39
2N5660	/454	1200	2000	250	200	6.0	40/120	500	0.4	1000	45	TO5
2N5662	/454	1200	2000	250	200	6.0	40/120	500	0.4	1000	45	TO5
2N5663	/454	1200	2000	250	200	6.0	40/120	500	0.4	1000	45	TO5
2N5666*	/455	1200	5000	250	200	6.0	40/120	1000	0.4	3000	90	TO5
2N5667*	/455	1200	5000	400	300	6.0	25/75	1000	0.4	3000	90	TO5
2N4150*	/394	1500	10000	100	70	7.0	40/120	5000	0.6	5000	350	TO5
2N5237*	/394	1500	10000	150	120	7.0	40/120	5000	0.6	5000	350	TO5

PNP Low Power Transistors (Notes 1, 2)

JAN Part No.	MIL-S-19500	Maximum Ratings					Primary Electrical Characteristics					Case
		P_T $T_A=25^\circ\text{C}$	I_C	V_{CBO}	V_{CEO}	V_{EBO}	h_{FE} at I_C		$V_{CE(sat)}$ at I_C		C_{obo}	
		(mW)	(mA)	(Vdc)	(Vdc)	(Vdc)	Min/Max	(mA)	(Vdc)	(mA)	(pF)	
2N4261*	/511	200	30	15	15	4.5	30/150	10	0.15	1.0	2.0	TO72
2N2907AU* (Note 3)	/291	400	600	60	60	5.0	100/300	150	1.6	500	8.0	TO18
2N2945A	/382	400	100	25	20	25.0	70/---	1.0	1.0	10	10	TO46
2N2946A	/382	400	100	40	35	40.0	50/---	1.0	2.0	10	10	TO46
2N5416	/485	750	1000	350	300	6.0	30/120	50	2.0	50	15	TO5
2N5415	/485	750	1000	200	200	6.0	30/120	50	2.0	50	15	TO5
2N3868*	/350	1000	3000	60	60	4.0	30/150	1500	0.75	1500	120	TO5
2N3867*	/350	1000	3000	40	40	4.0	40/200	1500	0.75	1500	120	TO5
2N3637*	/357	1000	1000	175	175	5.0	100/300	50	0.9	50	10	TO5
2N5153*	/545	1000	2000	100	80	5.5	70/200	2500	1.5	5000	250	TO39
2N6193*	/561	1000	5000	100	100	6.0	60/240	2000	0.7	2000	300	TO39

See notes on page 09-13.

NPN High Power Transistors (Notes 1, 2) (Page 1 of 2)

JAN Part No.	MIL-S-19500	P _T T _C =100°C (W)	Maximum Ratings				Primary Electrical Characteristics				Case
			I _C	V _{CBO}	V _{CEO}	V _{EBO}	h _{FE} at I _C		V _{CE} (sat)		
			(A)	(Vdc)	(Vdc)	(Vdc)	Min/Max	(A)	Max	(mA)	
2N5237*	/394	5	10	150	120	7.0	40/120	5.0	0.6	5	TO3
2N5238*	/394	5	10	200	170	7.0	40/120	5.0	0.6	5	TO3
2N3739	/402	10	3	325	300	6.0	40/200	0.1	2.5	0.25	TO66
2N5666*	/455	15	5	250	200	6.0	40/120	0.5	1.2	3.0	TO66
2N5667*	/455	15	5	400	300	6.0	40/120	1.0	1.2	3.0	TO66
2N5660	/454	20	2	250	200	6.0	40/120	0.5	1.2	0.4	TO66
2N3767	/518	25	4	100	80	6.0	40/160	0.5	1.0	0.5	TO66
2N2151	/277	30	2	150	100	6.0	40/120	1.0	0.1	1.0	TO59
2N3997*	/374	30	5	100	80	8.0	80/240	1.0	2.0	5.0	TO11
2N2880*	/315	30	5	110	80	8.0	40/120	1.0	0.25	1.0	STUD
2N5664*	/455	30	5	250	200	6.0	40/120	1.0	0.4	3.0	TO66
2N5665*	/455	30	5	400	300	6.0	25/75	1.0	0.4	3.0	TO66
2N3749*	/315	30	5	110	80	8.0	40/120	1.0	0.25	1.0	STUD
2N3996*	/374	30	5	100	80	8.0	40/120	1.0	2.0	5.0	TO11
2N3585	/384	35	2	500	300	7.0	25/100	1.0	0.75	1.0	TO66
2N3879	/526	35	7	120	75	8.0	20/180	4.0	1.2	4.0	TO66
2N2814	/415	50	10	120	80	5.5	50/150	1.0	0.5	5.0	TO61
2N5004	/534	58	5	100	80	6.0	70/200	2.5	1.5	5.0	TO59
2N3716	/408	85.7	10	100	80	7.0	30/120	3.0	1.0	5.0	TO66
2N5157	/371	100	3.5	700	500	7.0	30/90	1.0	0.8	1.0	TO3
2N3442	/370	117	10	160	140	7.0	20/70	3.0	1.0	3.0	TO3
2N5038*	/439	140	20	150	90	7.0	50/200	2.0	1.0	12	TO3
2N5672	/488	140	30	150	120	7.0	20/100	15	0.75	15	TO3
2N5039*	/439	140	20	125	75	7.0	30/150	2.0	1.0	12	TO3
2N6671	/536	150	8	450	300	8.0	10/80	1.0	1.0	5	TO3
2N5926	/447	200	50	150	120	10	20/80	20	0.6	50A	TO-210AE
2N5927	/440	200	100	150	120	10	30/120	20	0.75	70A	TO-114

See notes on page 09-13.

NPN High Power Transistors (Notes 1, 2) (Page 2 of 2)

JAN Part No.	MIL-S-19500	P _T T _C =100°C (W)	Maximum Ratings				Primary Electrical Characteristics				Case
			I _C	V _{CB0}	V _{CE0}	V _{EBO}	h _{FE} at I _C		V _{CE} (sat)		
			(A)	(Vdc)	(Vdc)	(Vdc)	Min/Max	(A)	Max	(mA)	
2N6673	/536	150	8	650	400	6.0	10/80	1.0	1.0	5	TO3
2N3716	/408	150	10	100	80	6.0	30/120	3.0	1.0	5	TO3
2N6249	/510	175	10	300	200	6.0	10/50	10	1.5	10	TO3
2N6250	/510	175	10	375	275	6.0	8/50	10	1.5	10	TO3
2N6251	/510	175	10	450	350	9.0	6/50	10	1.5	10	TO3
2N6546	/525	175	15	—	300	9.0	12/60	1	1.5	10	TO3
2N6547	/525	175	15	—	400	7.0	10/60	5	1.5	10	TO3
2N6674	/537	175	15	450	300	8.0	15/40	1	1.0	10	TO3
2N6676	/538	175	15	450	300	7.0	15/40	1	1.0	15	TO3
2N6675	/537	175	15	650	400	8.0	15/40	1	1.0	10	TO3
2N6678	/538	175	15	650	400	6.0	15/40	1	1.0	15	TO3
2N6338	/509	200	25	120	100	5.0	30/120	10	1.0	10	TO3
2N5302	/456	200	30	60	60	5.0	15/60	15	0.75	10	TO3
2N5303	/456	200	30	80	80	5.0	15/60	10	1.0	10	TO3
2N5685	/464	300	50	60	60	5.0	15/60	25	1.0	25	TO3
2N5686	/464	300	50	80	80	5.0	15/60	25	1.0	25	TO3
2N5250	/380	350	50	125	100	10	15/60	40	1.0	40	TO114
2N5251	/380	350	50	180	150	10	15/60	40	1.3	40	TO114

See notes on page 09-13.

PNP High Power Transistors (Notes 1, 2)

JAN Part No.	MIL-S-19500	Maximum Ratings					Primary Electrical Characteristics				Case
		P_T $T_C = 100^\circ\text{C}$	I_C	V_{CBO}	V_{CEO}	V_{EBO}	h_{FE} at I_C		V_{CE} (sat) at I_C		
		(W)	(A)	(Vdc)	(Vdc)	(Vdc)	Min/Max	(A)	(Vdc)	(A)	
2N3741*	/461	25	4	80	80	7.0	30/100	0.25	0.6	1.0	TO66
2N3740*	/441	25	4	60	60	7.0	30/120	0.25	0.6	1.0	TO66
2N6211	/461	35	2	275	225	6.0	30/175	1.0	1.4	1.0	TO66
2N6212	/461	35	2	350	300	6.0	35/175	1.0	1.6	1.0	TO66
2N6213	/461	35	2	400	350	6.0	30/175	1.0	2.0	1.0	TO66
2N5005	/535	58	10	100	80	5.5	70/200	2.5	1.5	5.0	TO59
2N3792	/379	150	10	80	80	7.0	30/120	3.0	1.0	5.0	TO3
2N6438	/508	200	25	140	120	6.0	25/100	10.0	1.0	10.0	TO3
2N5683	/466	300	50	60	60	5.0	15/60	25.0	1.0	25.0	TO3
2N5684	/466	300	50	80	80	5.0	15/60	25.0	1.0	25.0	TO3

See notes on page 09-13.

RF Transistors (Notes 1, 2)

JAN Part No.	MIL-S-19500	Maximum Ratings					Primary Electrical Characteristics					Case
		P_T TC=100°C	F	G_{PE} Min/Max	I_C	V_{CEO}	V_{CEO}	V_{EBO}	h_{FE} at I_C			
		(W)	(Mhz)	(dB)	(A)	(Vdc)	(Vdc)	(Vdc)	Min/Max	(mA)		
2N4957	/426	0.2	200	17/25	0.03	30	30	3.0	30/165	5.0	TO206	
2N2857*	/343	0.3	450	21/--	0.04	30	15	3.0	30/150	3.0	TO206	
2N5109*	/453	1.0	200	11/--	0.04	40	20	3.0	40/120	50.0	TO39	
2N3866A*	/398	1.0	400	1.2/2.0	0.04	60	30	3.5	25/200	50.0	TO205	

Quad Low Power MOSFETs (Notes 1, 2)

JANS or JANTXV	MIL-S-19500	Maximum Ratings			Primary Electrical Characteristics					Case
		Channel Polarity	P_T TC=25°C	V_{DS}	V_{GS}	I_D TC=25°C	V_{GS} (th) at I_D		$r_{DS(on)}$ $V_{GS}=10V$ Max	
			(W)	(Vdc)			(Vdc)	I_D		
2N7334	/597	4N	1.4	100	±20	1.0	2.0/4.0	0.25	0.7	DIP
2N7335	/599	4P	1.4	100	±20	0.075	2.0/4.0	0.25	1.4	DIP
2N7336	/598	2N, 2P	1.4	100	±20	0.075	2.0/4.0	0.25	1.4	DIP

See notes on page 09-13.

N-Channel Power MOSFETs (Notes 1, 2) (Page 1 of 2)

JAN Part No.	MIL-S-19500	Maximum Ratings				Primary Electrical Characteristics					Case
		P _T T _C = 25°C	V _{DS} (Vdc)	V _{GS} (Vdc)	I _D T _C = 25°C (A)	V _{GS} (th) at I _D		R _{DS(on)} V _{GS} =10V Max (Ohm)	g _{fs}		
						Min/Max	I _D		Min	Max	
		(W)	(Vdc)	(Vdc)	(A)	(Vdc)	(mA)	(Ohm)	(mhos)		
2N6660	/547	6.25	60	±20	0.99	0.8/2	1.0	3.0	—	—	TO39
2N6661	/547	6.25	90	±20	0.86	0.8/2	1.0	4.0	—	—	TO39
2N6901	/570	8.33	100	±10	1.69	1/2	1.0	1.4	0.3	12.0	TO39
2N6903	/570	8.33	200	±20	0.98	1/2	1.0	3.65	0.05	2.0	TO39
2N6782	/556	15	100	±10	3.50	2/4	0.25	0.6	1.0	3.0	TO39
2N6784	/556	15	200	±20	2.25	2/4	0.25	1.5	0.9	2.7	TO39
2N6786	/556	15	400	±20	1.25	2/4	0.25	3.6	0.7	2.1	TO39
2N6788	/555	20	100	±20	6.0	2/4	0.25	0.30	1.5	4.5	TO39
2N6790	/555	20	200	±20	3.5	2/4	0.25	0.80	1.5	4.5	TO39
2N6792	/555	20	400	±20	2.0	2/4	0.25	1.80	1.0	3.0	TO39
2N6794	/555	20	500	±20	1.5	2/4	0.25	3.00	1.0	3.0	TO39
2N6796	/557	25	100	±20	8.0	2/4	0.25	0.18	3.0	4.0	TO39
2N6798	/557	25	200	±20	5.5	2/4	0.25	0.4	2.5	7.5	TO39
2N6800	/557	25	400	±20	3.0	2/4	0.25	1.0	2.0	6.0	TO39
2N6802	/557	25	500	±20	2.5	2/4	0.25	1.5	1.5	4.5	TO39
2N6756	/542	75	100	±20	14.0	2/4	0.25	0.18	4.0	12.0	TO3
2N6758	/542	75	200	±20	9.0	2/4	0.25	0.4	3.0	9.0	TO3
2N6760	/542	75	400	±20	5.5	2/4	0.25	1.0	3.0	9.0	TO3
2N6762	/542	75	500	±20	4.5	2/4	0.25	1.5	2.5	7.5	TO3
2N6902	/566	75	100	±10	12	1/2	1.0	0.20	0.3	12.0	TO3
2N6904	/566	75	200	±10	8.0	1/2	1.0	0.65	0.3	12.0	TO3
2N7218U*	/596	125	100	±20	28.0	2/4	0.25	0.077	—	—	TO254
2N7219U*	/596	125	200	±20	18.0	2/4	0.25	0.18	—	—	TO254
2N7221U*	/596	125	400	±20	10.0	2/4	0.25	0.55	—	—	TO254
2N7222U*	/596	125	500	±20	8.0	2/4	0.25	0.85	—	—	TO254

See notes on page 09-13.

N-Channel Power MOSFETs (Notes 1, 2) (Page 2 of 2)

JAN Part No.	MIL-S-19500	Maximum Ratings				Primary Electrical Characteristics					Case
		P _T T _C = 25°C	V _{DS} (Vdc)	V _{GS} (Vdc)	I _D T _C = 25°C (A)	V _{GS(th)} at I _D		R _{DS(on)} V _{GS} =10V Max (Ohms)	g _{fs}		
						Min/Max	I _D		Min	Max	
		(W)	(Vdc)	(Vdc)	(A)	(Vdc)	(mA)	(Ohms)	(mhos)		
2N6764	/543	150	100	±20	38.0	2/4	0.25	0.055	9.0	27.0	TO3
2N6766	/543	150	200	±20	30.0	2/4	0.25	0.085	9.0	27.0	TO3
2N6768	/543	150	400	±20	14.0	2/4	0.25	0.300	8.0	24.0	TO3
2N6770	/543	150	500	±20	12.0	2/4	0.25	0.400	8.0	24.0	TO3
2N7224U* (Note 3)	/592	150	100	±20	34.0	2/4	0.25	0.070	—	—	TO254
2N7225	/592	150	200	±20	27.0	2/4	0.25	0.10	—	—	TO254
2N7227	/592	150	400	±20	14.0	2/4	0.25	0.315	—	—	TO254
2N7228U* (Note 3)	/592	150	500	±20	12.0	2/4	0.25	0.415	—	—	TO254
2N7236*	/595	125	200	±20	18.0	2/4	0.25	0.20	—	—	TO254
2N7237*	/595	125	200	±20	11.0	2/4	0.25	0.51	—	—	TO254
2N7334	/597	1.4	500	±20	1.0	2/4	0.25	0.70	—	—	M0Q36
2N7335	/599	1.4	500	±20	0.75	2/4	0.25	1.4	—	—	M0Q36
2N7336	/598	1.4	500	±20	1.0	2/4	0.25	0.7	—	—	M0Q36
R2N7261*	/601	25	100	±20	8.0	2/4	0.25	0.18	2.5	—	TO205
H2N7262	/601	25	200	±20	5.5	2/4	0.25	0.4	2.5	—	TO205
G2N7268*	/603	150	100	±20	34.0	2/4	0.25	0.065	8.0	—	TO254
R2N7269*	/603	150	200	±20	26.0	2/4	0.25	0.100	8.0	—	TO254

See notes on page 09-13.

P-Channel Power MOSFETs (Notes 1, 2)

JAN Part No.	MIL-S-19500	Maximum Ratings				Primary Electrical Characteristics					Case
		P _T T _C = 25°C	V _{DS}	V _{GS}	I _D T _C = 25°C	V _{GS(th)} at I _D		r _{DS(on)} V _{GS} =10V	g _{fs}		
						Min/Max	I _D	Max	Min	Max	
		(W)	(Vdc)	(Vdc)	(A)	(Vdc)	(mA)	(Ohms)	(mhos)		
2N6895	/565	8.33	100	±20	1.16	2/4	1.0	3.65	0.2	0.8	TO39
2N6845	/563	20	100	±20	4.0	2/4	0.25	0.6	1.25	3.75	TO39
2N6847	/563	20	200	±20	2.5	2/4	0.25	1.5	1.0	3.0	TO39
2N6849*	/564	25	100	±20	6.5	2/4	0.25	0.30	2.5	7.5	TO39
2N6851	/564	25	200	±20	4.0	2/4	0.25	0.80	2.2	6.6	TO39
2N6896	/565	60	100	±20	6.0	2/4	1.0	0.60	1.0	4.0	TO3
2N6804	/562	75	100	±20	11.0	2/4	0.25	0.30	3.0	9.0	TO3
2N6806*	/562	75	200	±20	6.5	2/4	0.25	0.8	2.0	6.0	TO3
2N6897*	/565	100	100	±20	12	2/4	1.0	0.35	2.0	8.0	TO3
2N7236*	/595	125	200	±20	18.0	2/4	0.25	0.20	—	—	TO254
2N7236U* (Note 3)	/595	125	100	±20	18	2/4	0.25	0.20	—	—	TO254
2N7237*	/595	125	200	±20	11.0	2/4	0.25	0.51	—	—	TO254
2N7237U* (Note 3)	/595	125	200	±20	11	2/4	0.25	0.51	—	—	TO254
2N6898	/565	150	100	±20	25	2/4	1.0	0.20	4.0	1.6	TO3

PNP Darlington Transistors (Notes 1, 2)

JAN Part No.	MIL-S-19500	Maximum Ratings					Primary Electrical Characteristics				Case
		P _T T _C =100°C	I _C	V _{CBO}	V _{CEO}	V _{EBO}	h _{FE} at I _C		V _{CE(sat)} at I _C		
							Min/Max		V _{CE(sat)}		
		(W)	(A)	(Vdc)	(Vdc)	(Vdc)	(x 1000)	(A)	(Vdc)	(A)	
2N6299	/540	32	8	80	80	5	0.75/18	4	2.0	4	TO66
2N6649	/527	85	10	60	60	5	1/20	5	2.0	5	TO3
2N6650	/527	85	10	80	80	5	1/20	5	2.0	5	TO3

See notes on page 09-13.

NPN Darlington Transistors (Notes 1, 2)

JAN Part No.	MIL-S-19500	Maximum Ratings					Primary Electrical Characteristics				Case
		P _T T _C =100°C (W)	I _C (A)	V _{CB0} (Vdc)	V _{CEO} (Vdc)	V _{EBO} (Vdc)	h _{FE} at I _C		V _{CE(sat)} at I _C		
							Min/Max (x 1000)	(A)	(Vdc)	(A)	
2N6350	/472	5	5	80	80	12	2/10	5	1.5	5	TO33
2N6351	/472	5	5	150	150	12	1/10	5	2.5	5	TO33
2N6352	/472	25	5	80	80	12	2/10	5	1.5	5	TO66
2N6353	/472	25	5	150	150	12	1/10	5	2.5	5	TO66
2N6301	/539	32	8	80	80	5	0.75/18	4	2.0	4	TO66
2N6384	/523	100	10	60	60	5	1/20	5	2.0	5	TO3
2N6385	/523	100	10	80	80	5	1/20	5	2.0	5	TO3
2N6283	/504	175	20	80	80	7	1.25/18	10	3.0	20	TO3
2N6284	/504	175	20	100	100	7	1.25/18	10	3.0	20	TO3

N-Channel FETs (Notes 1, 2)

JAN Part No.	MIL-S-19500	P _T T _A =25°C (mW)	Maximum Ratings				Primary Electrical Characteristics						Case
			V _{DG} (Vdc)	V _{DS} (Vdc)	V _{GS} (Vdc)	I _G (mA)	V _{GS(OFF)}		t _{ON} (ns)	t _{OFF} (ns)	I _{DSS} Min/Max (mA)	C _{iss} (pF)	
							Min (Vdc)	Max (Vdc)					
2N5545	/430	400	50	—	50	30	0.5	4.5	—	—	0.5/8.0	6	TO71
2N5546	/430	400	50	—	50	30	0.5	4.5	—	—	0.5/8.0	6	TO71
2N5547	/430	400	50	—	50	30	0.5	4.5	—	—	0.5/8.0	6	TO71
2N3821*	/375	300	50	—	50	10	—	4	—	—	0.5/2.5	6	TO72
2N3822*	/375	300	50	50	50	10	—	6	—	—	2/10	6	TO72
2N3823	/375	300	30	30	30	10	—	8	—	—	4/20	6	TO72
2N4856	/385	360	40	40	40	50	4	10	6	25	50/175	18	TO18
2N4857	/385	360	40	40	40	50	2	6	6	50	20/100	18	TO18
2N4858	/385	360	40	40	40	50	.8	4	10	100	8/80	18	TO18
2N4859	/385	360	30	30	50	50	4	10	6	25	50/175	18	TO18
2N4860	/385	360	30	30	50	50	2	6	6	50	20/100	18	TO18
2N4861	/385	360	30	30	50	50	0.8	4	10	100	8/80	18	TO18

See notes on page 09-13.

P-Channel FETs (Notes 1, 2)

JAN Part No.	MIL-S-19500	P _T T _A =25°C	Maximum Ratings					Primary Electrical Characteristics						Case
			V _{DG}	V _{DS}	V _{GS}	I _G	I _{GSS}	V _{GS(OFF)}		t _{ON}	T _{OF} F	I _{DSS} Min/Max	C _{iss}	
								Min	Max					
(mW)	(Vdc)	(Vdc)	(Vdc)	(mA)	(nA)	(Vdc)	(Vdc)	(ns)	(ns)	(mA)	(pF)			
2N5114	/476	500	30	30	30	50	1000	5	10	6	6	30/90	25	TO18
2N5115	/476	500	30	30	30	50	1000	3	6	10	8	15/60	25	TO18
2N5116	/476	500	30	30	30	50	1000	1	4	25	20	5/25	27	TO18

Silicon Dual Transistors, Complementary (Notes 1, 2)

JAN Part No.	MIL-S-19500	Maximum Ratings					Primary Electrical Characteristics					Case
		P _T Each Side T _A =25°C	I _C	V _{CB}	V _{CE}	V _{BE}	h _{FE} at I _C		V _{CE(sat)} at I _C		C	
							Min/Max	(mA)	(Vdc)	(mA)		
(mW)	(mA)	(Vdc)	(Vdc)	(Vdc)	Min/Max	(mA)	(Vdc)	(mA)	(pF)			
2N4854U	/421	300/600	600	60	40	5	100/300	150	0.4	150	300	(Note 3)

See notes on page 09-13.

Optocouplers (Notes 1, 2)

JAN Part No.	LED Section					PhotoTransistor						
	MIL-S-19500	I _F	I _P	V _F at I _F		V _{CEO}	V _{CBO}	V _{EBO}	V _{CE (SAT)} at I _C		t _r and t _f	Case
		(mA)	(A)	(Vdc)	(mA)	(Vdc)	(Vdc)	(Vdc)	(Vdc)	(mA)	(μs)	
4N22	/486	40	1	1.3	10	35	35	4	0.3	2.5		
4N23	/486	40	1	1.3	10	35	35	4	0.3	5.0		
4N24	/486	40	1	1.3	10	35	35	4	0.3	10.0		
4N47*	/548	40	1	1.5	10	40	45	7	0.3	2.0	20	TO-99
4N48*	/548	40	1	1.5	10	40	45	7	0.3	2.0	20	TO-99
4N49*	/548	40	1	1.5	10	40	45	7	0.3	2.0	25	TO-99

Notes:

1. An asterisk (*) next to the device number indicates that the part is available to both JANS and JANTXV assurance levels. The absence of the asterisk indicates that the part is available only to the JANTXV assurance level. All JANS transistors are preferred Grade 1 parts.
2. All JANTXV transistors must be PIND tested in accordance with Appendix A and are preferred Grade 2 parts.
3. For transistors which are available in leaded and unleaded (U designation) configurations, the leaded package (case) is designated. Refer to the detail specification for surface mount (unleaded) package outlines.

THIS PAGE INTENTIONALLY LEFT BLANK

Summary of Preferred Microcircuits

Description	Refer to Page No.
MIL-M-38510 Part Number Explanation	10-2
MIL-I-38535 Part Number Explanation	10-2
Low Power Schottky: 54LS Series	10-3
Advanced Low Power Schottky: 54ALS Series	10-5
Digital CMOS: 4000B Series	10-5
Advanced Schottky: 54F Series	10-6
CMOS High Speed: 54HC/HCT Series	10-7
Advanced CMOS Technology: 54AC/ACT Series	10-8
BIPOLAR and MOS Memories	10-9
MOS Microprocessors and Interface Peripherals	10-9
Semi-Custom Bipolar Array Logic	10-10
Application-Specific-Integrated Circuits (ASIC) and Masked Gate Arrays	10-11
Linear Bipolar and Bi-FETs	10-12
Linear CMOS	10-14
Summary of Preferred Hybrid Microcircuits	10-15

MIL-M-38510 Part Number Explanation (Note 1)

Part Number Explanation:						
M38510	/or M, D, R, H	XXX	XX	X	X	X
Military Designator	Radiation Hardness Assurance (RHA) Designator	Detailed Specification	Device Type	Device Class	Case Outline	Lead Finish
	<div style="border: 1px solid black; padding: 5px; width: fit-content;"> M = 3×10^3 RAD (Si) D = 1×10^4 RAD (Si) R = 1×10^5 RAD (Si) H = 1×10^6 RAD (Si) </div>	Establishes detail requirements and specific electrical characteristics of the microcircuits.	Determines the specific circuit.	S = Grade 1 B = Grade 2	Defines package type.	A - Hot solder dip B - Tin Plate C - Gold Plate

MIL-I-38535 SMD One-Part-One Part Number Explanation (Note 1)

Part Number Explanation:						
5962	/or M, D, R, H	XXXXX	XX	X	X	X
Military Designator	Radiation Hardness Assurance Designator	Drawing Designator	Device Type	Device Class	Case Outline	Lead Finish
	<div style="border: 1px solid black; padding: 5px; width: fit-content;"> M = 3×10^3 RAD (Si) D = 1×10^4 RAD (Si) R = 1×10^5 RAD (Si) H = 1×10^6 RAD (Si) </div>	Establishes detail requirements and specific electrical characteristics of the microcircuits.	Determines the specific circuit.	V = Grade 1 Q = Grade 2	Defines package type.	A - Hot solder dip B - Tin Plate C - Gold Plate

See notes on page 10-19.

Low Power Schottky: 54LS Series (Notes 2, 3) (Page 1 of 2)

Generic Number	MIL-M-38510	Circuit Description
Gates		
54LS00	/30001*	QUAD 2-INPUT, NAND
54LS03	/30002*	QUAD 2-IN, NAND, OPEN COLLECTOR
54LS04	/30003*	HEX INVERTER
54LS05	/30004*	HEX INVERTER OPEN-COLLECTOR O/P
54LS10	/30005*	TRIPLE 3-INPUT NAND
54LS20	/30007*	DUAL 4-INPUT NAND
54LS22	/30008	4-INPUT OPEN COLLECTOR NAND
54LS02	/30301	QUAD 2-INPUT NOR
54LS27	/30302	TRIPLE 3-INPUT NOR
54LS51	/30401	DUAL 2-WIDE AND-OR-INVERTER
54LS32	/30501	QUAD 2-INPUT OR
54LS86	/30502*	QUAD 2-INPUT X-OR
54LS08	/31004	QUAD 2-INPUT AND
54LS09	/31005	2-INPUT, OPEN COLLECTOR AND
54LS11	/31001*	TRIPLE 3-INPUT AND
54LS21	/31003*	DUAL 4-INPUT AND
54LS26	/32102	2-INPUT OPEN COLLECTOR, NAND
Buffers/Drivers		
54LS365	/32201	HEX, COMMON ENABLE, 3-STATE
54LS366	/32202	HEX, INV, COMMON ENABLE, 3-STATE
54LS367	/32203	HEX, 4-BIT/2-BIT, NONINV, 3-STATE
54LS368	/32204	HEX, 4-BIT/2-BIT, INVERTING., 3-STATE
54LS125A	/32301	QUAD, NONINV 3- STATE
54LS126	/32302	QUAD, NONINV 3- STATE
54LS240	/32401	OCTAL, INVERTER, 3- STATE
54LS245	/32803	OCTAL, BUS TRANSCEIVER, 3-STATE

Generic Number	MIL-M-38510	Circuit Description
Buffers/Drivers		
54LS241	/32402	OCTAL, NONINV, 3- STATE OUTPUTS
54LS244	/32403*	OCTAL, NONINV, 3- STATE OUTPUTS
54LS365	/32201	HEX, NONINV, 3-STATE OUTPUTS
54LS366	/32202	HEX, INVERTER, 3-STATE OUTPUTS
54LS367	/32203	HEX, NONINV, 3-STATE OUTPUTS
54LS38	/30203	QUAD, 2-INPUT NAND OPEN-COLL.
54LS541	/32405	OCTAL, NONINV, 3-STATE OUTPUTS
Latches		
54LS75	/31601	D-TYPE, 4-BIT BISTABLE
54LS279	/31602	RS, QUAD
54LS259	/31603	D-TYPE, OCTAL, ADDRESSABLE
54LS377	/32504	D-TYPE, OCTAL
54LS373	/32502	D-TYPE, OCTAL, TRANSPARENT
Flip-Flops		
54LS74A	/30102	D-TYPE, DUAL
54LS112	/30103	JK, DUAL WITH RESET/CLEAR, NEG.
54LS113	/30104	JK, DUAL WITH RESET/ CLEAR
54LS174	/30106	D-TYPE, HEX
54LS175	/30107	D-TYPE, QUAD
54LS109	/30109	JK, DUAL WITH RESET/CLEAR, POS.
54LS76A	/30110	JK, DUAL, NEGATIVE EDG-TRIG
54LS273	/32501	D-TYPE, OCTAL WITH CLEAR
54LS374	/32503	D-TYPE, OCTAL, 3-STATE OUTPUTS
54LS123	/31401	MONOSTABLE, DUAL, RETRIG.
54LS221	/31402	MONOSTABLE, DUAL, RETRIG.
54LS173A	/36101	D-TYPE, QUAD

See notes on page 10-19.

Low Power Schottky: 54LS Series (Notes 2, 3) (Page 2 of 2)

Generic Number	MIL-M-38510	Circuit Description
Combinational Gates		
54LS138	/30701*	3-LINE-TO-8-LINE DECODER
54LS139	/30702	DUAL 2-LINE-TO-4-LINE DECODER
54LS42	/30703*	BCD-TO-7-SEGMENT DECODER
54LS151	/30901	8-IN PUT DATA SELECT/MULTIPLEXER
54LS153	/30902*	DUAL 4-INPUT DATA SELECT/MUX
54LS157	/30903*	QUAD 2-INPUT DATA SELECT/MUXER
54LS158	/30904*	QUAD 2-INPUT INV. OUTPUTS MUX
54LS251	/30905*	8-BIT 3-STATE, DATA SELECT/MUX
54LS257B	/30906	2-INPUT 3- STATE DATA SELECT/MUX
54LS258B	/30907	2-INPUT 3- STATE DATA SELECT/MUX
54LS253	/30908*	4-INPUT 3- STATE DATA SELECT/MUX
54LS85	/31101	4-BIT MAGNITUDE COMPARATOR
54LS83A	/31201	4-BIT FULL ADDER, FAST CARRY
54LS283	/31202	4-BIT FULL ADDER , FAST CARRY
54LS280	/32901	9-BIT PARITY GENERATOR/CHECKER
54LS148	/36001	8-LINE-TO-3-LINE PRIORITY ENCODER
54LS348	/36002	8-TO-3-LINE PRIORITY ENCODER

See notes on page 10-19.

Generic Number	MIL-M-38510	Circuit Description
Shift Registers		
54LS194A	/30601*	4- BIT BIDIRECTIONAL
54LS195A	/30602	4- BIT PARALLEL ACCESS
54LS95B	/30603	4-BIT PARALLELEL ACCESS
54LS96	/30604	5-BIT SHIFT REGISTER
54LS164	/30605*	8-BIT PARALLEL-OUT, SERIAL-IN
54LS295B	/30606	4-BIT BIDIRECTIONAL
54LS395A	/30607	4-BIT UNIVERSAL
54LS165A	/30608	8-BIT PARALLEL-IN, SERIAL-OUT
54LS166	/30609	8-BIT PARALLEL-IN, SERIAL-OUT
54LS670	/31901	4 X 4 , 3-STATE OUTPUTS REGISTER FILE
Counters		
54LS90	/31501	4-BIT DECADE
54LS93	/31502	4-BIT DECADE
54LS160A	/31503	4-BIT SYNC DECADE
54LS161	/31504	4-BIT SYNC BINARY, ASYNC RESET
54LS193	/31508	4-BIT SYNC BIN UP/DOWN
54LS191	/31509	4-BIT SYNC BIN UP/DOWN
54LS92	/31510	DIVIDE-BY-12
54LS163A	/31512	4-BIT SYNC BINARY, SYNC RESET
54LS197	/32002	PRESET 50/30 MHZ BINARY
54LS290	/32003	4-BIT DECADE
54LS293	/32004	4-BIT BINARY
54LS390	/32701	DUAL 4-BIT A&B I/P DECADE
54LS393	/32702	DUAL 4-BIT BINARY

Advanced Low Power Schottky: 54ALS Series

Generic Number	MIL-M-38510	Circuit Description
Gates/Combinational Gates		
54ALS00A	/37001	QUAD 2-INPUT NAND
54ALS10	/37002	TRIPLE 3-INPUT NAND
54ALS20A	/37003	DUAL 4-INPUT NAND
54ALS30A	/37004	8-INPUT NAND
54AL133	/37005	13-INPUT NAND
54ALS04B	/37006	HEX INVERTER
54ALS02	/37301	QUAD 2-INPUT NOR
54ALS27	/37302	TRIPLE 3-INPUT NOR
54ALS08	/37401	QUAD 2-INPUT AND
54ALS11	/37402	TRIPLE 3-INPUT AND
54ALS32	/37501	QUAD 2-INPUT OR
54ALS1000A	/38401	QUAD 2-INPUT NAND
54ALS1002	/38402	QUAD 2-INPUT NOR
54ALS1020	/38407	DUAL 4-INPUT NAND
54ALS138	/37701	3-TO-8-LINE DECODER/DEMUX
Buffers/Drivers		
54ALS1034	/38411	HEX , NONINV BUFFER/DRIVER
54ALS240A	/38301	OCTAL , BUFFER, INV. , 3-STATE OUTPUT
54ALS241	/38302	OCTAL , BUFFER, NONINV, 3-STATE OUTPUT
54ALS244B	/38303	OCTAL , BUFFER, NONINV, 3-STATE OUTPUT
Flip-Flops		
54ALS109A	/37102	JK , DUAL , PRESET(ACTIVE HIGH)
54ALS112A	/37103	JK , DUAL , PRESET(ACTIVE LOW)
54ALS174	/37201	D-TYPE , HEX , WITH CLEAR
54ALS175	/37202	D-TYPE , QUAD , WITH CLEAR
54ALS373	/37203	D-TYPE , OCTAL , 3-STATE OUTPUTS
54ALS374	/37204	D-TYPE , OCTAL , EDGE-TRIGGER
54ALS573	/38201	D-TYPE ,OCTAL , 3--STATE OUTPUTS
54ALS574A	/37104	D-TYPE , OCTAL
54ALS74A	/37101	D-TYPE, DUAL -POSITIVE TRIGGER
Counters		
54ALS161B	/38001	4-BIT SYNC, BINARY
54ALS163B	/38002	4-BIT SYNC, CLEAR BINARY
54ALS169B	/38003	4-BIT SYNC, UP/DOWN BINARY

Digital CMOS: 4000B Series (Notes 2, 3)

Generic Number	MIL-M-38510	Circuit Description
Gates/Combinational Gates		
4001B	H05252*	QUAD, 2-INPUT NOR
4002B	H05253*	DUAL, 4-INPUT NOR
4025B	H05254*	TRIPLE, 3-INPUT NOR
4011B	H05051*	QUAD, 2-INPUT NAND
4012B	H05052*	DUAL, 4-INPUT NAND
4023B	H05053*	TRIPLE, 3-INPUT NAND
4007UB	H05351*	DUAL, COMPLEMENTARY PAIR, INVERTER
4019B	H05352*	QUAD, AND-OR SELECT
4070B	H17203*	QUAD, 2-INPUT X-OR
4071B	H17101*	QUAD, 2-INPUT OR
4072B	H17102*	DUAL, 4-INPUT OR
4075B	H17103*	TRIPLE, 3-INPUT OR
4081B	H17001*	QUAD, 2-INPUT AND
4082B	R17002	DUAL, 4-INPUT AND
4073B	R17003	TRIPLE, 3-INPUT AND
4077B	R17204	QUAD, 2-INPUT X-NOR
4085B	H17201*	DUAL, AND-OR-INVERT, 2-WIDE, 2-INPUT
4086B	H17202*	DUAL, AND-OR-INVERT, 4-WIDE, 2-INPUT
4049UB	H05553*	HEX BUFFER, INVERTING
4050B	H05554*	HEX BUFFER
4041UB	R05555	QUAD, TRUE COMPLEMENT BUFFER
4069UB	H17401*	HEX INVERTER
4502B	R17403*	HEX INVERTER/BUFFER
4028B	R05951*	BCD-TO-DECIMAL DECODER
4066B	H05852*	QUAD, BILATERAL SWITCH
Flip-Flops		
4098B	R17504	MONOSTABL MULTIVIBRATOR, DUAL
4099B	R17601	D-TYPE , OCTAL LATCH,
4013B	H05151*	D-TYPE, DUAL, EDGE-TRIGGERED
4027B	H05152*	JK, DUAL
Sequential Registers/Counters		
4008B	R05451*	4-BIT FULL ADDER
4017B	H05651*	DECADE COUNTER/DIVIDER
4020B	H05653*	BIN COUNT ER, 14-STAGE CARRY
4022B	H05654*	OCTAL COUNTER W/8 DECODED OUTPUT
4024B	H05655*	7-STAGE RIPPLE CARRY COUNT/DIVIDE
4014B	H05752*	8-BIT SERIAL/PARALLEL REGISTER
4015B	H05753*	DUAL, SERIAL IN, PARALLEL OUT
4021B	H05754*	8-BIT ASYNC PARALLEL IN/SERIAL OUT

See notes on page 10-19.

Advanced Schottky: 54F Series (Notes 2, 3)

Generic Number	MIL-M-38510	Circuit Description
Gates		
54F00	/33001*	QUAD, 2-INPUT NAND
54F04	/33002*	HEX, INVERTER
54F10	/33003*	TRIPLE, 3-INPUT NAND
54F20	/33004*	DUAL, 4-INPUT NAND
54F02	/33301*	QUAD, 2-INPUT NOR
54F64	/33401*	4-2-3-2 INPUT AND-/OR-INVERTER
54F08	/34001*	QUAD, 2-INPUT AND
54F11	/34002*	QUAD, 2-INPUT AND
54F32	/33501*	QUAD, 2-INPUT OR
54F86	/34501*	QUAD, 2-INPUT EXCLUSIVE-OR
Buffers/Drivers		
54F240	/33201	OCTAL, INV, 3-STATE OUTPUTS
54F241	/33202*	OCTAL, NONINV, 3-STATE OUTPUTS
54F244	/33203*	OCTAL, NONINV, 3-STATE OUTPUTS
54F245	/34803*	OCTAL, NONINV, BUS TRANSCEIVER
54F365	/35101	HEX, NONINV, 3-STATE OUTPUTS
Flip-Flops		
54F074	/34101*	D-TYPE, DUAL
54F109	/34102	JK, DUAL
54F175	/34104	D-TYPE, QUAD
54F374	/34105	D-TYPE, OCTAL 3-STATE OUTPUTS
54F534	/34106	D-TYPE, OCTAL 3-STATE OUTPUTS
54F174	/34107*	D-TYPE, HEX
54F373	/34601*	D-TYPE, OCTAL, 3-STATE OUTPUTS
54F533	/34602	D-TYPE, OCTAL 3-STATE OUTPUTS
54F563	/34603	D-TYPE, OCTAL, 3-STATE OUTPUTS
54F573	/34604	D-TYPE, OCTAL 3-STATE OUTPUTS

Generic Number	MIL-M-38510	Circuit Description
Combinational Gates		
54F138	/33701*	3-TO-8-LINE DECODER
54F139	/33702*	DUAL, 2-LINE-TO-4-LINE DECODER
54F151A	/33901*	8-INPUT DATA SELECT, MULTIPLEXER
54F153	/33902*	DUAL, 4-INPUT DATA SELECT, MUX
54F157A	/33903*	QUAD, 2-INPUT DATA SELECT, MUX
54F158A	/33904*	QUAD, 2-INPUT DATA SELECT, MUX
54F181	/33801	4-BIT ALU GENERATOR
54F182	/33802	LOOK AHEAD CARRY GENERATOR
54F251A	/33905*	8-INPUT, 3-STATE OUTPUTS, MUX
54F253	/33908*	DUAL, 4-INPUT, 3-STATE OUTPUTS, MUX
54F257A	/33906*	QUAD, 2-INPUT, 3-STATE OUTPUTS, MUX
54F258A	/33907*	QUAD, 2-INPUT, 3-STATE OUTPUTS, MUX
54F280	/34901*	9-BIT PARITY GENERATOR/CHECKER
54F283	/34201*	4-BIT FULL ADDER
54F521	/34701*	8-BIT IDENTITY COMPARATOR
54F398	/35001*	QUAD, 2-INPUT WITH STORAGE MUX
Counters/Shift Registers		
54F160A	/34401*	4-BIT SYNC BCD DECADE COUNTER
54F161A	/34301*	4-BIT SYNC BINARY COUNTER
54F163A	/34302*	4-BIT SYNC BINARY COUNTER
54F192	/34404	4-BIT SYNC UP/DOWN DECADE COUNTER
54F193	/34304	4-BIT SYNC UP/DOWN BINARY COUNTER
54F194	/33601*	4-BIT BIDIRECT. UNIVERSAL SHIFT REGISTER

See notes on page 10-19.

CMOS High-Speed: 54HC/HCT Series (Notes 2, 3)

Generic Number	MIL-M-38510	Circuit Description
Gates		
54HC00	/65001	QUAD, 2-INPUT NAND
54HC10	/65002	TRIPLE, 3-INPUT NAND
54HC20	/65003	DUAL, 4-INPUT NAND
54HC30	/65004	8-INPUT NAND
54HC02	/65101	QUAD, 2-INPUT NOR
54HC27	/65102	TRIPLE, 3-INPUT NOR
54HC266	/65103	QUAD, 2- INPUT EXCLUSIVE- NOR
54HC4002	/65104	DUAL, 4-INPUT NOR
54HCT04	/65751	HEX, INVERTER (TTL)
54HC04	/65701	HEX, INVERTER
54HC14	/65702	SCHMITCH- TRIGGER HEX INVERTER
54HC08	/65203	QUAD, 2-INPUT AND
54HC11	/65204	TRIPLE, 3-INPUT AND
54HC32	/65201	QUAD, 2-INPUT OR
54HC86	/65202	QUAD, 2-INPUT X-OR
Buffers/Drivers		
54HC245	/65503	OCTAL, XSCEIVER, NONINV., 3-STATE
54HCT245	/65553	OCTAL, XSCEIVER, NONINV., 3-ST (TTL)
54HCT240	/65753	OCTAL, INV. WITH 3-STATE OUTPUTS
54HC240	/65703	OCTAL, INV. WITH 3- STATE OUTPUTS
54HC365	/65706	HEX, NONINV WITH 3- STATE OUTPUTS
54HC367	/65708	HEX, NONINV WITH 3- STATE OUTPUTS
54HC368	/65709	HEX, INV. WITH 3- STATE OUTPUTS
54HC540	/65710	OCTAL, INV, 3- STATE OUTPUTS
54HC541	/65711	OCTAL, NONINV, WITH 3-STATE OUTPUTS
54HCT244	/65755	OCTAL, NONINV, 3-STATE OUTPUTS (TTL)

Generic Number	MIL-M-38510	Circuit Description
Flip-Flops		
54HC74	/65302	D-TYPE , DUAL , WITH PRESET AND CLEAR
54HC109	/65304	JK, DUAL
54HC112	/65305	JK, DUAL WITH R/S
54HC173	/65306	D-TYPE, QUAD WITH 3-STATE OUTPUTS
54HC174	/65307	D-TYPE, HEX WITH CLEAR
54HC175	/65308	D-TYPE, QUAD
54HCT74	/65352	D-TYPE, DUAL R/C (TTL)
54HC273	/65601	D-TYPE, OCTAL WITH CLEAR
54HC574	/65604	D-TYPE, OCTAL WITH 3-STATE OUTPUTS
54HCT374	/65652	D-TYPE, OCTAL (TTL), NON-INVERTING
Latches		
54HC259	/65402	D-TYPE, OCTAL ADDRESSABLE
54HC373	/65403	D-TYPE, OCTAL WITH 3-STATE OUTPUTS
54HC573	/65406	D-TYPE, OCTAL WITH 3-STATE OUTPUTS
54HCT373	/65453	D-TYPE, OCTAL (TTL), TRANSPARENT
Combinational Gates		
54HCT138	/65852	3-LINE-TO-8-LINE DECODER (TTL)
54HC138	/65802	3-LINE-TO-8-LINE DECODER
54HC139	/65803	DUAL, 2 TO 4 LINE DECODER
Counters		
54HC161	/66302	4-BIT BINARY COUNTER, ASYNC RESET
54HC163	/66304	4-BIT BINARY COUNTER, SYNC RESET
54HC393	/66309	DUAL, 4-BIT BINARY COUNTER

See notes on page 10-19.

Advanced CMOS Technology: 54AC/ACT Series (Notes 2, 3)

Generic Number	MIL-M-38510	Circuit Description
Gates		
54AC00	R75001*	QUAD, 2-INPUT NAND
54AC10	R75002*	TRIPLE, 3-INPUT NAND
54AC20	R75003*	DUAL, 4-INPUT NAND
54AC02	R75101*	QUAD, 2-INPUT NOR
54AC04	R75701*	HEX INVERTER
54AC14	R75702*	SCHMITT TRIGGER, HEX INVERTER
54AC08	R75203*	QUAD, 2-INPUT AND
54AC11	R75204*	TRIPLE, 3-INPUT AND
54AC32	R75201*	QUAD, 2-INPUT OR
54AC86	R75202*	QUAD, 2-INPUT X-OR
Buffers/Drivers		
54AC240	R75703	OCTAL, INV, 3- STATE OUTPUTS
54AC241	R75704*	OCTAL, NONINV, 3- STATE OUTPUTS
54AC244	R75705*	OCTAL, NONINV, 3- STATE OUTPUTS
54AC245	R75503*	OCTAL, BUS TRANSCEIVER , BIDIRECTIONAL, 3-STATE OUTPUTS

Generic Number	MIL-M-38510	Circuit Description
Combinational Gates		
54AC138	R75802*	3-LINE-TO-8-LINE DECODER/DEMUX
54AC139	R75803*	DUAL, 2-TO-4 DECODER/ DEMUX
54AC151	/76201*	8-INPUT MULTIPLEXER
54AC153	/76202*	DUAL, 4-INPUT MULTIPLEXER
54AC157	/76203*	QUAD, 2-INPUT MULTIPLEXER
Shift Registers		
54AC299	/76506*	8-BIT UNIVERSAL PARALLEL
Flip-Flops		
54AC273	/75601*	D-TYPE , OCTAL WITH CLEAR
54AC377	/75603*	D-TYPE, OCTAL, CLOCK ENABLE
54AC373	R75403*	D-TYPE , OCTAL, 3-STATE OUTPUTS
54AC74	/75302*	D-TYPE, DUAL, POSITIVE EDGE- TRIGGER
54AC574	/75604*	D-TYPE, OCTAL, 3-STATE OUTPUTS
54AC374	/75606*	D-TYPE , OCTAL, 3-STATE OUTPUTS
54AC109	/75304*	JK, DUAL, POSITIVE EDGE-TRIGGER

See notes on page 10-19.

Generic Number	5962	Circuit Description
Comparators		
54AC520	-90916*	8-BIT MAGNITUDE COMPARATOR, PULL- UP RESISTOR
54AC521	R90985*	8-BIT MAGNITUDE COMPARATOR
Gates		
54ACT00	R8769901*	QUAD 2-INPUT NAND
Buffers/Drivers		
54ACT240	R8775901	OCTAL, INV, 3- STATE OUTPUTS
54ACT244	R8776001*	OCTAL, NON-INV, 3- STATE OUTPUTS
54ACT245	R8766301*	OCTAL, BIDIRECTIONAL XCEIVER, 3-STATE
Combinational Gates		
54ACT138	-8755401*	3-LINE-TO-8-LINE DECODER
54ACT151	-8875601*	8-INPUT MULTIPLEXER
Flip-Flops		
54ACT377	-8769701*	D-TYPE, OCTAL, CLOCK ENABLE
54ACT74	-8752501*	D-TYPE, DUAL, POSITIVE EDGE-TRIGGER
54ACT574	-8960101*	D-TYPE, OCTAL, 3-STATE OUTPUTS

Bipolar and MOS Memories (Notes 2,3)

Generic Number	MIL-M-38510	Size	Circuit Description Access Time
Bipolar PROMs			
82S185	/20902	2K X 4,	125 NS, 3-STATE OUTPUT
82S191	/21002	2K X 8,	125 NS, 3-STATE OUTPUT
MOS SRAMs			
2147	/28903	4K X 1,	55 NS, 3-STATE OUTPUT
2148	/28904	1K X 4,	55 NS, 3-STATE OUTPUT
2147	/28901	4K X 1,	35 NS
2148	/28902	1K X 4,	35 NS
2147	/23801	4K X 1,	85 NS, 3-STATE OUTPUT
2147H	/23803	4K X 1,	70 NS
2147H-3	/23805	4K X 1,	55 NS
2148	/23806	1K X 4,	70 NS
2147H-2	/23807	4 K X 1,	45 NS
6504	/24501	4K X 1,	300 NS
6514	/24502	1K X 4,	300 NS
6116	/29104	2K X 8,	90 NS
6516	/29102	2K X 8,	200 NS
65162	/29110	2K X 8,	70 NS
65262	/29103	16K X 1,	85 NS
65262	/29109	16K X 1,	150 NS, 3-STATE OUTPUT
65642	/29205	8K X 8,	150 NS

Generic Number	5962	Size	Circuit Description Access Time
SRAMs			
(Note 3)	H3829437*	8K X 8,	55 NS, RAD-HARD
"	H3829436*	8K X 8,	70 NS, RAD-HARD
"	H3829435*	8K X 8,	85 NS, RAD-HARD
"	H9215305*	32 K X 8,	60 NS, RAD-HARD
"	H9215307*	32 K X 8,	40 NS, RAD-HARD
"	H9312802*	256 K X 1,	60 NS, RAD-HARD
"	H9312803*	256 K X 1,	40 NS, RAD-HARD

See notes on page 10-19.

MOS Microprocessors and Interface Peripherals

Generic Number	5962	Circuit Description
Microprocessor/Microcontroller		
MQ80386Q20	-8766803	32 BIT, 20 MHZ MICROPROCESSOR
QM80386Q25	-8766804	32 BIT, 25 MHZ MICROPROCESSOR
MQ80387Q-XX	-89534XX	80 BIT NUMERIC PROCESSOR
LORFXPC	H9202601*	FIXED POINT PROCESSOR
LORFLPC	H9210301*	FLOATING POINT PROCESSOR
LORAP1C	H9210401*	ADDRESS PROCESSOR ONE
LORAP2C	H9210601*	ADDRESS PROCESSOR TWO

Generic Number	MIL-M-38510	Circuit Description
Bus Interfaces		
UT1553BRTI	/55501	MIL-STD-1553 RT INTERFACE

Semi-Custom Bipolar Array Logic (Notes 2, 3)

Generic Number	MIL-M-38510	Circuit Description
Semi-Custom Linear Cell Arrays		
RLA80	/70601	<= 8 MACROCELL LOCATIONS
RLA120	/70602	<= 12 MACROCELL LOCATIONS
RLA160	/70603	<= 12 MACROCELL LOCATIONS
Bipolar Programmable Array Logic (PAL)		
PAL16L8A	/50401	16 - IN, 8 - OUT, AND-OR-INVERT
PAL16L8A-2	/50407	16 - IN, 8 - OUT, AND-OR-INVERT
PAL16L8A-20	/50601	16 - IN, 8 - OUT, AND-OR-INVERT
PAL16L8A-30	/50605	16 - IN, 8 - OUT, AND-OR-INVERT
PAL16R4A	/50405	16 - IN, 4 - OUT, AND-OR
PAL16R6A	/50403	16 - IN, 6 - OUT, AND-OR
PAL16R8A	/50402	16 - IN, 8 - OUT, AND-OR
PAL16R6A-20	/50603	16 - IN, 6 - OUT, AND-OR-, 20 NS
PAL16R6A-30	/50607	16 - IN, 6 - OUT, AND-OR-, 30 NS
PAL16R4A-20	/50604	16 - IN, 4 - OUT, AND-OR-, 20 NS
PAL16R4A30	/50608	16 - IN, 8 - OUT, AND-OR-, 30 NS
PAL16R8A-20	/50602	16 - IN, 8 - OUT, AND-OR-, 20 NS
PAL16R8A-30	/50606	16 - IN, 8 - OUT, AND-OR-, 30 NS
PAL20L8A-15	/50501	20 - IN, 8 - OUT, AND-OR-INVERT
PAL20R4A-15	/50504	20 - IN, 4 - OUT, AND-OR
PAL20R6A-15	/50503	20 - IN, 6 - OUT, AND-OR
PAL20R8A-16	/50502	20 - IN, 8 - OUT, AND-OR

See notes on page 10-19.

Application-Specific-Integrated-Circuits (ASIC) and Masked Gate Arrays (Note 4)

Manufacturer	Process Technology	RHA	Grade	Circuit Description
UTMC	1.2 μm DLM CMOS	H	1, 2	25,000 - 105,000 Gates
	1.5 μm DLM CMOS	H	1, 2	
	1.2 μm TLM CMOS	H		
Honeywell	1.2 μm RICMOS III	H	1, 2	10,000 - 340,000 Gates
	0.8 μm RICMOS IV	H	1, 2	
Loral	1.0 μm RHC MOS	H	1, 2	50,000 - 300,000 Gates
	1.0 μm RHC MOS-E	H	1, 2	
	0.5 μm HMC MOS	H	1, 2	
AMI	1.25 μm DLM CMOS	N/A	2	10,000-300,000 Gates

See notes on page 10-19.

Linear Bipolar and Bi-FETs (Notes 2, 3) (Page 1 of 2)

Generic Number	MIL-M-38510	Circuit Description
Operational Amplifiers		
101A	/10103*	SINGLE, EXT. COMPENSATED
108A	/10104*	SINGLE, EXT. COMPENSATED
118	/10107*	PRECISION, HIGH SPEED
741A, 148	/10101*	SINGLE, INT. COMPENSATED
L558	/10108*	DUAL, INT. COMPENSATED
LH2108A	/10106	DUAL, EXT. COMPENSATED
747A	/10102*	DUAL, INT. COMPENSATED
LH2101A	/10105	DUAL, HIGH PERFORMANCE
4136	/11004*	QUAD
4156, 4741	/11003	QUAD
124, 2101A	/11005	QUAD, LOW POWER
124A	/11006*	QUAD, SINGLE SUPPLY
148	/11001*	QUAD, MEDIUM POWER
155	/11401*	JFET INPUT, LOW POWER
155A	/11404*	JFET INPUT, LOW POWER
156A	/11405*	JFET INPUT, HIGH PERFORM.
156	/11402*	JFET INPUT, LOW POWER
157	/11403	JFET INPUT, LOW POWER
157A	/11406	JFET INPUT, HIGH PERFORM.
2500	/12204	SINGLE, HIGH PRECISION/ SLEW
2510	/12205	SINGLE, HIGH PRECISION/ SLEW
2520	/12206	SINGLE, HIGH SLEW
2600	/12202	SINGLE, WIDEBAND
2620	/12203	SINGLE HIGH SPEED, WIDEBAND
OP-07	/13502*	LOW OFFSET
OP-27A	/13503*	PRECISION
OP-07A	/13501*	ULTRA LOW OFFSET
LF411M, 071	/11904	BI-FET, LOW POWER
LF153, 072	/11905	BI-FET, LOW POWER, DUAL
LF1 47, 074	/11906	BI-FET, LOW POWER, QUAD
5532A	/13102	LOW NOISE, DUAL
5534A	/13101	LOW NOISE

Generic Number	MIL-M-38510	Circuit Description
Transmission Line Receivers/Drivers		
55107A	/10401	LINE RECEIVER, DUAL DIFFERENTIAL
55108	/10402	LINE RECEIVER, DUAL DIFFERENTIAL
55114 9614	/10403	LINE RECEIVER, DUAL DIFFERENTIAL
55115, 9615	/10404	LINE RECEIVER, DUAL DIFFERENTIAL
55113	/10405	LINE DRIVER, DUAL DIFFERENTIAL
55114	/10403	LINE DRIVER, DUAL DIFFERENTIAL
55451	/12902	PERIPHERAL DRIVER, DUAL AND
55452	/12903	PERIPHERAL DRIVER, DUAL NAND
55454	/12905	PERIPHERAL DRIVER, DUAL NOR
55462	/12908	PERIPHERAL DRIVER, DUAL NAND
55463	/12909	PERIPHERAL DRIVER, DUAL OR
Comparators		
111	/10304*	VOLTAGE COMPARATOR/ BUFFER DUAL,
119	/10306*	SINGLE HIGH SPEED
119A	/10307*	DUAL, HIGH SPEED
2111	/10305*	DUAL, PRECISION COMPARATOR
711	/10302	DUAL, HIGH SPEED
710	/10301	SINGLE, HIGH SPEED
139	/11201*	QUAD, SINGLE SUPPLY, LOW POWER
193	/11202	DUAL, LOW POWER/OFFSET
Timers		
555	/10901*	TIMER, PRECISION
556	/10902	DUAL, PRECISION

See notes on page 10-19.

Linear Bipolar and Bi-FET Devices (Notes 2, 3) (Page 2 of 2)

Generic Number	MIL-M-38510	Circuit Description
Voltage Regulators		
109	/10701*	5V FIXED POSITIVE, 1.5A
140LAH-05,78M05	/10702	5V FIXED POSITIVE, 0.5A
140LAH-12,78M12	/10703	12V FIXED POSITIVE, 0.5A
140LAH-15, 78M15	/10704	15V FIXED POSITIVE, 0.5A
40AAK-05, 7805	/10706	5V FIXED POSITIVE, 1.0A
140AK-12,7812	/10707	12V FIXED POSITIVE, 1.0A
140AK-15, 7815	/10708	15V FIXED POSITIVE, 1.0A
140AK-24, 7824	/10709	24V FIXED POSITIVE, 1.0A
120H-05, 79M05	/11501*	5V FIXED NEGATIVE, 0.5A
120H-12, 79M12	/11502*	12V FIXED NEGATIVE, 0.5A
120H-15, 79M15	/11503*	15V FIXED NEGATIVE, 0.5A
120K-05, 7905	/11505*	12V FIXED NEGATIVE, 0.5A
120K-12, 7912	/11506*	5V FIXED NEGATIVE, 1.0A
120K-15, 7915	/11507*	15V FIXED NEGATIVE, 1.0A
120K24, 7924	/11508	24V FIXED NEGATIVE, 1.0A
137H	/11803*	ADJUSTABLE NEGATIVE, 0.5A
137K	/11804*	ADJUSTABLE NEGATIVE, 1.5A
117H	/11703*	ADJUSTABLE POSITIVE, 0.5A
117K	/11704*	ADJUSTABLE POSITIVE, 1.5A
138K	/11706	ADJUSTABLE POSITIVE
LT1009	/14802*	PROGRAMMABLE V REF.
AD584S	/12801	PROGRAMMABLE V REF
AD584T	/12802	PROGRAMMABLE V REF.
1524, 1846	/12601	PULSE WIDTH MODULATOR,
1525A	/12602	REGULATING
1526	/12603	
1527A	/12604	

Generic Number	MIL-M-38510	Circuit Description
Transistor Arrays		
2001	/14101	DARLINGTON TRANSISTORS
2002	/14102	
2003	/14103	
2004	/14104	
2005	/14105	
2801	/14106	
2802	/14107	
2803	/14108	
2804	/14109	
2805	/14110	
D/A Converters		
DAC08S	/11301*	8-BIT, HIGH SPEED MULTIPLYING
DAC08SA	/11302*	8-BIT, HIGH SPEED MULTIPLYING
AD562	/12101	12-BIT, CURRENT OUTPUT
AD565	/12103	12-BIT, CURRENT OUTPUT
AD561	/13301	10-BIT, CURRENT OUTPUT
A/D Converters		
574AU	/14001	12-BIT, 35 μS
574AT	/14002	12-BIT
S/H Amplifiers		
198	/12501*	SAMPLE AND HOLD AMPLIFIER
Multipliers		
AD534T	/13901	4-QUADRANT, 1% ERROR, 1MHZ BW
AD534S	/13902	4-QUADRANT, 1% ERROR, 1MHZ BW
AD532S	/13903	4-QUADRANT, 4% ERROR, 1MHZ BW

See notes on page 10-19.

Linear CMOS (Notes 2, 3)

Generic Number	MIL-M-38510/	Circuit Description
Analog Switches		
181A	/11101	SPST, 2- CHANNEL
182A	/11102	SPST, 2- CHANNEL
184A	/11103	DPST, 2- CHANNEL_
185A	/11104	DPST, 2- CHANNEL
187A	/11105	SPST
188A	/11106	SPDT
190A	/11107	SPDT, 2- CHANNEL
191A	/11108	SPDT, 2- CHANNEL
200	/12301	SPST, 2-CHANNEL
201	/12302	SPST, 4- CHANNEL
300	/11601	SPST, 2-CHANNEL
301	/11602	SPDT, 1-CHANNEL
302	/11603	DPST, 2-CHANNEL
303	/11604	SPDT, 2-CHANNEL
304	/11605	SPST, 2-CHANNEL
305	/11606	SPDT, 2-CHANNEL
306	/11607	DPST, 2-CHANNEL
307	/11608	SPDT, 2-CHANNEL
5040	/10501	SPST, 1-CHANNEL
5041	/10502	SPST, 2-CHANNEL
5042	/10503	SPDT, 1-CHANNEL
5043	/10504	SPDT, 2-CHANNEL
5044	/10505	DPST, 1-CHANNEL
5045	/10506	DPST, 2-CHANNEL

Generic Number	MIL-M-38510/	Circuit Description
Analog Multiplexers/ Demultiplexers (MUX/DEMUX)		
506	/19001	MUX, 16 -CHANNEL
506A	/19002	MUX/DEMUX, 16-CHANNEL
507	/19003	MUX, DIFFERENTIAL 8-CHANNEL
507A	/19004	MUX/DEMUX, 8-CHANNEL
508	/19007	MUX/DEMUX, 8-CHANNEL
508A	/19005	MUX/DEMUX, 8-CHANNEL
509	/19008	MUX/DEMUX, , 4-CHANNEL
509A	/19006	MUX/DEMUX, DIFF. 4-CHANNEL

See notes on page 10-19.

Summary of Preferred Hybrid Microcircuits

Description	Refer to Page No.
MIL-H-38534 SMD One-Part-One Part Number Explanation	10-16
SMD Non-One-Part-One Part Number Explanation	10-16
MIL-STD-1553 Peripherals/Controller Bus Interfaces	10-17
Optocouplers	10-17
A/D and D/A Converters	10-17
Voltage References and Regulators	10-18
DC/DC Converters	10-18

MIL-H-38534 SMD One-Part-One Part Number Explanation (Note 5)

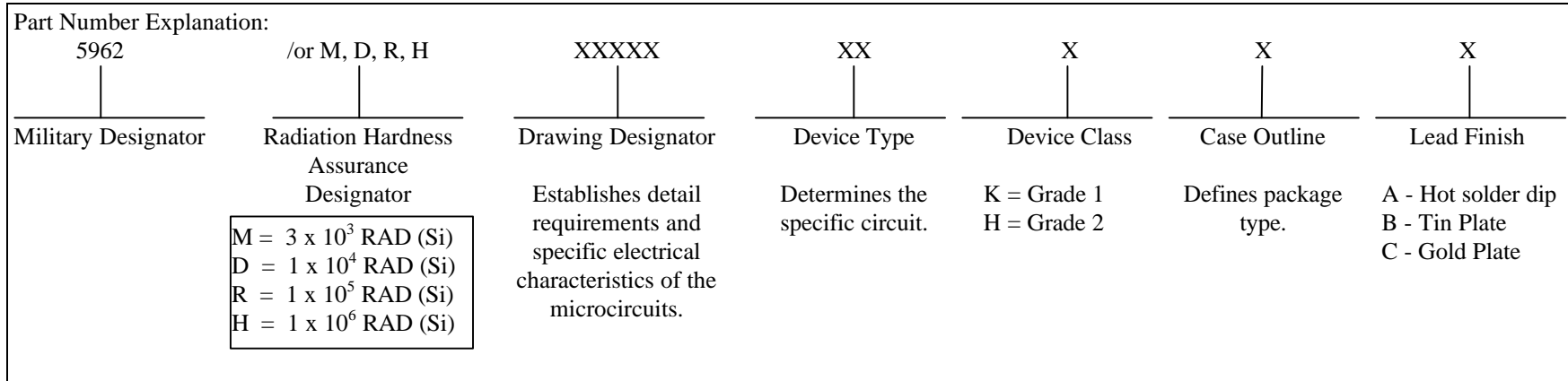

SMD Non-One-Part-One Part Number Explanation (Note 5)

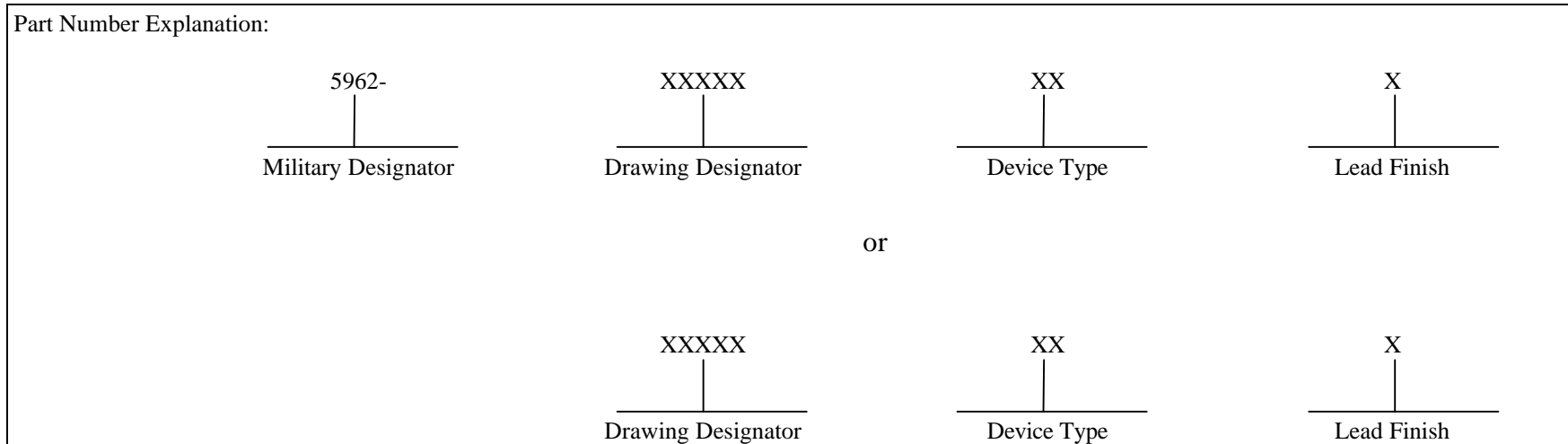

See notes on page 10-19.

Hybrid Microcircuits

Generic Number	5962 or SMD No.	Circuit Description
MIL-STD-1553 Peripherals/Controller Bus Interfaces		
(NOTE 3)	-88692XX	BC/RTU/MT, MUX TERMINAL
(NOTE 3)	-91734XX	BC/RTU/MT, MUX TERMINAL
(NOTE 3)	-87535XX	DUAL REDUNDANT RTU
(NOTE 3)	-91786XX	DUAL REDUNDANT RTU
(NOTE 3)	-89798XX	DUAL REDUNDANT RTU
(NOTE 3)	-87579XX	DRIVER/RECEIVER, DUAL CHANNEL
(NOTE 3)	-89447XX	DRIVER/RECEIVER, DUAL CHANNEL
(NOTE 3)	-89522XX	DRIVER/RECEIVER, DUAL CHANNEL
(NOTE 3)	-89826XX	DRIVER/RECEIVER, DUAL CHANNEL
(NOTE 3)	-92061XX	DRIVER/RECEIVER, DUAL CHANNEL
(NOTE 3)	-86049XX	DRIVER/RECEIVER, SINGLE CHANNEL
(NOTE 3)	-91749XX	DRIVER/RECEIVER, SINGLE CHANNEL
(NOTE 3)	-92085XX	DRIVER/RECEIVER, SINGLE CHANNEL
(NOTE 3)	-88586XX	BUS TO μ PROCESSOR INTERFACE
(NOTE 3)	-92162XX	BUS INTERFACE, RTU, DUAL
(NOTE 3)	-93065XX	MUX TERMINAL W/ 4K RAM
Optocouplers		
HCPL-5761	-8947701	AC/DC TO LOGIC INTERFACE
4N55	-8767901	2-CHANNEL
(NOTE 3)	8102801	2-CHANNEL
HCPL-5231	-8876902	2-CHANNEL
HCPL-1931	-89572XX	2-CHANNEL
HCPL-5531	-8767902	2-CHANNEL, COMMON SUPPLY
HCPL5431	-8957101	2-CHANNEL, COMMON SUPPLY
(NOTE 3)	-8978501	2-CHANNEL, COMMON SUPPLY
HCPL-6531	-8767903	2-CHANNEL, SEPARATE SUPPLY
(NOTE 3)	-8978502	2-CHANNEL, SEPARATE SUPPLY
HCPL-6231	-8876901	2-CHANNEL, SEPARATE SUPPLY
HSSR-7111	-9314001	1-CHANNEL, POWER MOSFET
(NOTE 3)	-8981001	1-CHANNEL, HIGH GAIN
HCPL-5201	-8876801	1-CHANNEL
66079	-9167601	1-CHANNEL
HCPL5401	-8957001	1-CHANNEL, HIGH SPEED
HCPL5601	-9085501	1-CHANNEL, HIGH SPEED
(NOTE 3)	-9085401	1-CHANNEL, TRANSISTOR OUTPUT

See notes on page 10-19.

(Note 5) (Page 1 of 2)

Generic Number	5962 or SMD No.	Circuit Description
A/D Converters		
(NOTE 3)	-88508XX	A/D, 12-BIT
AD9005ATM	-9066601	A/D, 12-BIT
CLC925B8C	-9099501	A/D, 12-BIT
MN5200-5206	-89583XX	A/D, 12-BIT
AD578	-89658XX	A/D, 12-BIT, HIGH-SPEED
MN5210-5215	-89584XX	A/D, 12-BIT, HIGH-SPEED
ADC00302	-88542XX	A/D, 12-BIT, TRACK/HOLD
MN5246	-89595XX	A/D, 12-BIT, \pm 2.5V
SP9588	-9063101	A/D, 14-BIT
MN5295	-8956901	A/D, 16-BIT
MN5290/5291	-8956301	A/D, 16-BIT
MN6400	-9177001	A/D, 16-BIT
MN6450	-9225301	A/D, 16-BIT
AD1385	-9171201	A/D, 16-BIT
HS9576	-90795XX	A/D, 16-BIT, \pm 0.003 %FSR
HS1068	-8877601	A/D, 8-BIT FLASH
SP1078	-8997901	A/D, 8-BIT FLASH
MN5143	-90497XX	A/D, 8-BIT, 0 TO +10V INPUT RANGE
MN5100/5101	-92073XX	A/D, 8-BIT FLASH
MN5142/ 5141	-90497XX	A/D, 8-BIT, \pm 10V
D/A Converters		
ADH030	-9063401	D/A, 12-BIT
DAC HKB	-8952801	D/A, 12-BIT, BINARY INPUT CODE
MN3860	-9057001	D/A, 12-BIT, INPUT REGISTER
DAC02310	-88517XX	D/A, 12-BIT, DEGLITCHED
(NOTE 3)	-89531XX	D/A, 16-BIT, 0 TO 10V
HS9378	-89862XX	D/A, 16-BIT
MN3009/3008	-8768801	D/A, 8-BIT, \pm 2V OUTPUT
RGBDAC3808	-89509XX	D/A, 8-BIT, TRIPLE
HS/MN 3020	-89718XX	D/A, 8 -BIT, WITH INPUT REGISTER
AD390	-88509XX	D/A, 12-BIT, QUAD
AD394	-88510XX	D/A, 12-BIT, QUAD
HS9342	-88629XX	D/A, 12-BIT, QUAD

Hybrid Microcircuits (Note 5) (Page 2 of 2)

Generic Number	5962 or SMD No.	Circuit Description
Voltage References and Regulators		
(NOTE 3)	-93134XX	VOLT. REGULATOR
OM7501-7509	-89490XX	VOLT. REGULATOR FIXED, DUAL VOLT OUT
DC/DC Converters		
MHF-2805S	-9213901	12W, 5V SINGLE OUTPUT
MHF-2812S	-9166401	15W, 12V SINGLE OUTPUT
MHF-2852S	-9160101	15W, 15V SINGLE OUTPUT
MHF-2812D	-9214401	15W, ±12V DUAL OUTPUT
MHF-2815D	-9161401	15W, ±15V DUAL OUTPUT
MTR-2805S	-9306801	25W, 5V SINGLE OUTPUT
MTR-2805D	-9320501	25W, ±5V DUAL OUTPUT
MTR-2812S	-9306901	30W, 12V SINGLE OUTPUT
MTR-2815S	-9307001	30W, 15V SINGLE OUTPUT
MTR-2818S	-9320201	30W, 18V SINGLE OUTPUT
MTR-2812D	-9307101	30W, ±12V DUAL OUTPUT
MTR-2815D	-9307201	30W, ±15V DUAL OUTPUT
MFL-2805S	-9316301	50W, 5V SINGLE OUTPUT
MFL-2805D	-9319101	50W, ±5V DUAL OUTPUT
MSA-2815S	-9309401	5W, 15V SINGLE OUTPUT
MSA-2815D	-9309001	5W, ±15V DUAL OUTPUT
MFL-2812S	-9316201	60W, 12V SINGLE OUTPUT
MFL-2815S	-9316101	60W, 15V SINGLE OUTPUT
MSA-2812D	-9308901	5W, ±12V DUAL OUTPUT
MFL-2812D	-9319201	60W, ±12V DUAL OUTPUT
MFL-2815D	-9319301	60W, ±15V DUAL OUTPUT
MSA-2812S	-9309301	5W, 12V SINGLE OUTPUT
MSA-2805S	-9309201	5W, 5V SINGLE OUTPUT

See notes on page 10-19.

Notes for Preferred Microcircuits and Hybrids

Notes:

1. Preferred microcircuits may be purchased to MIL-M-38510 detailed specifications or MIL-I-38535 one-part-one-part number Standard Military Drawings (SMDs). M38510 Class S and SMD Class V microcircuits are considered preferred Grade 1 parts, and M38510 Class B and SMD Class Q microcircuits, with the addition of PIND testing in accordance with Appendix A, are considered preferred Grade 2 parts. MIL-M-38510 has been incorporated into MIL-I-38535 as Appendix A and all future microcircuit specifications will be written as SMDs (one-part-one part number).
2. An asterisk (*) next to SMD number indicates that parts are available in both classes V/S/K and Q/B/H. The absence of the asterisk indicates that parts are available only as class Q/B/H.
3. No generic number is applicable to these parts, since different manufacturers have different part ID numbers. Refer to or QML-38535, or QML-38534 for the manufacturer's listed part number.
4. The customer controls the design details by defining the application-specific requirements completely within the Altered Item Drawing (AID). The AID does not need to specify the quality and reliability requirements, as these are covered under the QML-38535 SMD certification and qualification requirements; however, the AID needs to supplement the requirements for specific design and fault coverage measurements in accordance with Method 5012 of MIL-STD-883.
5. Preferred hybrid microcircuits are usually purchased to MIL-H-38534 One-Part-One-Part Number Standard Military Drawings (SMDs). Class K hybrids would normally be considered Grade 1 parts, but none are currently listed as preferred parts. Class H hybrids are listed and, with the addition of PIND testing, in accordance with Appendix A, are considered preferred Grade 2 parts. These can be purchased to either MIL-H-38534 SMDs using the one-part-one-part number designation, or to older SMDs which use the non-one-part-one number designation.

THIS PAGE INTENTIONALLY LEFT BLANK

Summary of Preferred Thermistors

Style	Description	Specification	Resistance Range at +25°C (ohms)		Grades	Refer To
			Minimum	Maximum		
311P18	Negative Temperature Coefficient, Insulated and Uninsulated	GSFC S-311-P-18	2252	3000	1, 2	Page 14-2
RTH	Positive Temperature Coefficient, Insulated	MIL-R-23648/19 (Note 1)	10	10000	1, 2	Page 14-3

Notes:

1. Effective with Revision D, dated 4 April 1995, MIL-R-23648 superseded MIL-T-23648C. The associated detail specifications were also changed from MIL-T-23648/XX to MIL-R-23648/XX on the same date.

GSFC S-311-P-18 Thermistors, Insulated and Uninsulated, Nonhermetic (Note 1)

Part Number Explanation:			
311P18	-XX	X	XXX
GSFC Prefix	Dash number corresponds to the zero-power resistance of the thermistor @ 25°C	Lead Material Type: S = 32AWG tinned solid copper wire, LW(0.20)C-51-N per MIL-STD-1276 N = 32AWG solid nickel wire, LW(0.20)N-01-N per MIL-STD-1276 A = 28AWG silver coated stranded wire, ETFE per M22759/33-28-9 T = 28AWG silver coated stranded wire, PTFE per M16878/6BCB9 E = 32AWG tinned solid copper wire, LW(0.20)C-51-N per MIL-STD-1276, one lead bare, one lead insulated with PTFE tubing per MIL-I-22129, covered with heat shrinkable FEP insulation per M23053/11-105-C	Lead Length (cm) (Note 2)

Grade 1 and 2 Part Numbers	Control Specification	Temperature Coefficient	Zero Power Resistance (at +25°C) (Ohms)	Tolerance Limits (0 to +70°C) (+%R)	Operating and Storage Temperature Limits (°C)	Resistance Ratio ($R_{25°C}/R_{min}$)	Thermal Time Constant (maximum) (sec)	Dissipation Constant (minimum) (mW/°C)
311P18-01XXXX	GSFC S-311-P-18	Negative	2252	1.02	-55 to +90	10.93	10.0 (Note 3)	1.0 (Note 4)
311P18-02XXXX			2252	0.51	-55 to +70	5.71		
311P18-03XXXX			3000	1.02	-55 to +90	10.91		
311P18-04XXXX			3000	0.56	-55 to +70	5.71		
311P18-05XXXX			5000	1.02	-55 to +90	10.91		
311P18-06XXXX			5000	0.51	-55 to +70	5.71		
311P18-07XXXX			10000	0.93	-55 to +90	9.23		
311P18-08XXXX			10000	0.56	-55 to +70	5.03		
311P18-09XXXX			30000	1.00	-55 to +90	10.72		
311P18-10XXXX			30000	0.50	-55 to +70	5.60		

Notes:

1. WARNING: Use heat sinks when soldering or welding to thermistor leads.
2. Standard lead lengths are from 7.6 to 100 cm. The lead length in centimeters (cm) is specified by three characters. For lengths from 7.6 to 9.9 cm, the letter "R" is used as the decimal point (e.g., 7R6 = 7.6 cm). For lengths 10 cm to 99 cm, the letters "R" is used as the last character (e.g., 76R = 76 cm). For 100 cm lead length, the digits are 101. The first two digits represent significant figures, and the last digit specifies the number of zeros to follow.
3. For a thermistor suspended in still air, the thermal constant is 10 seconds maximum, except lead style "E", 25 seconds maximum.
4. For thermistors suspended in still air only (does not apply for lead style "E").

MIL-R-23648 Thermistors, Insulated, Hermetic (Note 1)

Part Number Explanation:				
RTHXX	X	X	XXX	X
RTH - Identifies general purpose thermistors. XX represents a two-digit number which identifies the physical configuration.	Resistance Ratio Characteristic: E = 0.55 ± 10%	Lead Type S = Solderable	Zero Power Resistance @ +25°C (Note 2)	Zero Power Resistance Tolerance @ +25°C J = ± 5% (Note 3)

Grade 1 and 2 Part Numbers	Control Specification	Style	Temperature Coefficient	Resistance Ratio	Resistance Values @ +25°C (ohms)		Thermal Time Constant (maximum) (sec)	Dissipation Constant (minimum) (mW/°C)	Power Rating @ +25°C (watts)
					(min)	(max)			
RTH42ESXXXX	MIL-R-23648/19	RTH42	Positive	E = 0.55 ± 10%	10	10K	60	2.5	0.25

Notes:

1. Parts covered by this specification contain internal connections that may reflow during installation. Heat sinking is recommended during mounting to prevent internal solder reflow.
2. The resistance is expressed in ohms and identified by a three digit number. The first two digits represent significant figures, and the last digit specifies the number of zeros to follow. See MIL-R-23648 for a list of standard resistance values for the 10 to 100 decade.
3. The specified zero power resistance tolerance is for the reference temperature (+25°C) only. See MIL-R-23648 to determine resistance tolerance changes versus temperature and MIL-R-23648/19 for factors to determine the resistance at various temperatures.

THIS PAGE INTENTIONALLY LEFT BLANK

Index of Preferred Transformers

There are no preferred Grade 1 or Grade 2 transformers.

Grade 1 and Grade 2 transformers must meet the requirements of MIL-STD-981, Class S and Class B respectively.

THIS PAGE INTENTIONALLY LEFT BLANK

Summary of Preferred Wire and Cable (Notes 1 through 3) (Page 1 of 2)

	Specification	Refer to Page No.
Insulation Selection Guideline		16-3
Color Code Designators for Wire	MIL-STD-681	16-5
MIL-W-22759 Wire, PTFE Insulated (Polytetrafluoroethylene), Copper or Copper Alloy		16-6
Silver Coated, 600 Volt, 200°C	MIL-W-22759/11	16-7
Nickel Coated, 600 Volt, 260°C	MIL-W-22759/12	16-7
Silver Coated, 600 Volt, 200°C (High Strength)	MIL-W-22759/22	16-7
Nickel Coated, 600 Volt, 260°C (High Strength)	MIL-W-22759/23	16-7
Silver Coated, 1000 Volt, 200°C	MIL-W-22759/9	16-8
Silver Coated, 1000 Volt, 200°C (High Strength)	MIL-W-22759/20	16-8
MIL-W-22759 Wire, ETFE Insulated (Ethylene Tetrafluoroethylene), Copper or Copper Alloy		
Tin Coated, 600 Volt, 150°C, Medium Weight Insulation	MIL-W-22759/16	16-9
Tin Coated, 600 Volt, 150°C, Lightweight Insulation	MIL-W-22759/18	16-9
Crosslinked ETFE, Tin Coated, 600 Volt, 150°C, Lightweight	MIL-W-22759/32	16-10
Crosslinked ETFE, Tin Coated, 600 Volt, 150°C, Normal weight	MIL-W-22759/34	16-11
Crosslinked ETFE, Silver Coated, 600 Volt, 200°C, Lightweight	MIL-W-22759/44	16-10
Crosslinked ETFE, Silver Coated, 600 Volt, 200°C, Normal weight	MIL-W-22759/43	16-11
Crosslinked ETFE, Silver Coated, 600 Volt, 200°C, Lightweight (High Strength)	MIL-W-22759/33	16-10
Crosslinked ETFE, Silver Coated, 600 Volt, 200°C, Normal weight (High Strength)	MIL-W-22759/35	16-11
Crosslinked ETFE, Nickel Coated, 600 Volt, 200°C, Lightweight	MIL-W-22759/45	16-10
Crosslinked ETFE, Nickel Coated, 600 Volt, 200°C, Normal weight	MIL-W-22759/41	16-11
MIL-W-81381 Wire, FEP Fluorocarbon/Polyimide Insulated, Copper or Copper Alloy		16-12
Silver Coated, 600 Volt, 200°C	MIL-W-81381/7	16-13
Nickel Coated, 600 Volt, 200°C	MIL-W-81381/8	16-13
Tin Coated, 600 Volt, 150°C	MIL-W-81381/21	16-13
Silver Coated, 600 Volt, 200°C	MIL-W-81381/9	16-13
Nickel Coated, 600 Volt, 200°C	MIL-W-81381/10	16-13

See notes on page 16-2.

Summary of Preferred Wire and Cable (Notes 1 through 3) (Page 2 of 2)

	Specification	Refer to Page No.
S-311-P-13 Wire, High Voltage, Crosslinked Polyalkene Over Crosslinked PVDF Insulation, Copper Conductor, Tin Coated		16-14
600 Volt, 135°C	S-311-P-13/1	16-14
1000 Volt, 135°C	S-311-P-13/2	16-14
2500 Volt, 135°C	S-311-P-13/3	16-14
Multiconductor Cable Shielded and unshielded, jacketed and unjacketed	MIL-C-27500	16-15
Radio Frequency Coaxial Cable Flexible and Semi-Rigid	MIL-C-17	16-16
J-W-1177 Magnet Wire, Copper, Enamel Coated		16-17
Polyurethane Overcoated with Polyamide, 130°C	J-W-1177/9	16-17
Polyester-Imide or Polyester-Amide-Imide, 180°C	J-W-1177/12	16-17
Polyester Overcoated with Polyamide-Imide, 200°C	J-W-1177/14	16-17
Polyimide-Coated, 200°C	J-W-1177/15	16-17

Notes:

1. All wire and cable may be used in Grade 1 or 2 applications.
2. The following are common trade names for insulations: PTFE & FEP, DuPont™ Teflon, ETFE and Crosslinked ETFE DuPont™ Tefzel, Polyvinylidene Fluoride (PVDF, PVF₂) Penwalt™ Kynar, Polyester DuPont™ Dacron, Polyimide DuPont™ Kapton, Polyamide DuPont™ Nylon.
3. Wire size AWG24 and larger is preferred for conductors used in interconnecting cable and harness assemblies. High strength copper alloy shall be used for size AWG24 and smaller.

Insulation Selection Guidelines (Page 1 of 2)

Insulation Types	Advantages	Disadvantages
FEP and PTFE (DuPont™ Teflon)	<ol style="list-style-type: none"> 1. Excellent high temperature properties. PTFE Teflon is preferred for solder applications. FEP is preferred for jacket material. 2. Non-flammable. 3. Good outgassing characteristics. 4. Most flexible of all insulations. 5. Good weatherability, resists moisture absorption and atomic oxygen erosion. 	<ol style="list-style-type: none"> 1. Susceptible to cold flow when stressed (bent) over tight radius or when laced too tightly. 2. Degraded by solar radiation above 5×10^5 RADS. 3. FEP has poor cut through resistance. 4. Heaviest insulation.
ETFE (DuPont™ Tefzel)	<ol style="list-style-type: none"> 1. Withstands physical abuse during and after installation. 2. Good high and low temperature properties. 3. High flex life. 4. Good outgassing characteristics. 5. Fair cold flow properties 	<ol style="list-style-type: none"> 1. Some ETFE insulations fail flammability in a 30% oxygen environment. 2. Insulation tends to soften at high temperature. 3. Degraded by gamma radiation above 10^6 rads
Crosslinked ETFE (DuPont™ Tefzel)	<ol style="list-style-type: none"> 1. Higher strength than normal ETFE. 2. Resistant to cold flow and abrasion. 3. More resistant to radiation effects. (to 5×10^7 RADS) 4. Higher maximum temperature than normal ETFE. Tin Coating = 150°C Max Silver Coating = 200°C Max 5. Good outgassing characteristics. 	<ol style="list-style-type: none"> 1. Some ETFE insulations fail flammability in a 30% oxygen environment. 2. Less flexible than extruded ETFE.
Aromatic Polyimide (DuPont™ Kapton)	<ol style="list-style-type: none"> 1. Lightest weight wire insulation material. Commonly used with FEP or PTFE Teflon to form layered insulation tapes. 2. Excellent physical thermal and electric properties. Excellent cut-through resistance and cold flow resistance. 3. Excellent radiation resistance (to 5×10^9 RADS). 4. Good outgassing characteristics. 	<ol style="list-style-type: none"> 1. Inflexibility - difficult to strip. 2. Absorbs moisture. Degraded by atomic oxygen. Poor weatherability. 3. Prone to wet-arc and dry-arc tracking from abrasions and cuts. 4. More difficult to flex. 5. Not stable to ultraviolet radiation.

Insulation Selection Guidelines (Page 2 of 2)

Insulation Types	Advantages	Disadvantages
Crosslinked Polyalkene	<ol style="list-style-type: none"> 1. Dual extrusion which is fused by sintering. Combines excellent abrasion and cut through resistance of Polyvinylidene Fluoride (PVDF, PVF₂ - Penwalt Corp TM Kynar) with Polyolefin for greater flexibility and improved heat resistance. Polyalkene is used mainly as a primary insulation under an outer jacket such as crosslinked ETFE or crosslinked PVDF/PVF₂. 2. High dielectric constant, used in high voltage applications. 3. PVDF has good radiation resistance (to 10⁸ RADS). 4. More resistant to cold flow. 5. Good outgassing characteristics. 	<ol style="list-style-type: none"> 1. Lower maximum conductor temperature rating. (135°C for GSFC S-311-P-13) (150°C for MIL-W-81044) 2. Reduced flexibility.

Color Code Designators for Wire According to MIL-STD-681

Base Color	1st Stripe	2nd Stripe	Designator
Black			0
Brown			1
Red			2
Orange			3
Yellow			4
Green			5
Blue			6
Violet			7
Gray			8
White			9
White	Black		90
White	Brown		91
White	Red		92
White	Orange		93
White	Yellow		94
White	Green		95
White	Blue		96
White	Violet		97
White	Gray		98

Base Color	1st Stripe	2nd Stripe	Designator
White	Black	Brown	901
White	Black	Red	902
White	Black	Orange	903
White	Black	Yellow	904
White	Black	Green	905
White	Black	Blue	906
White	Black	Violet	907
White	Black	Gray	908
White	Brown	Red	912
White	Brown	Orange	913
White	Brown	Yellow	914
White	Brown	Green	915
White	Brown	Blue	916
White	Brown	Violet	917
White	Brown	Gray	918
White	Red	Orange	923
White	Red	Yellow	924
White	Red	Green	925
White	Red	Blue	926
White	Red	Violet	927
White	Red	Gray	928

Base Color	1st Stripe	2nd Stripe	Designator
White	Orange	Yellow	934
White	Orange	Green	935
White	Orange	Blue	936
White	Orange	Violet	937
White	Orange	Gray	938
White	Yellow	Green	945
White	Yellow	Blue	946
White	Yellow	Violet	947
White	Yellow	Gray	948
White	Green	Blue	956
White	Green	Violet	957
White	Green	Gray	958
White	Blue	Violet	967
White	Blue	Gray	968

MIL-W-22759 Wire, Fluoropolymer-Insulated, Copper or Copper Alloy (Notes 1, 2)

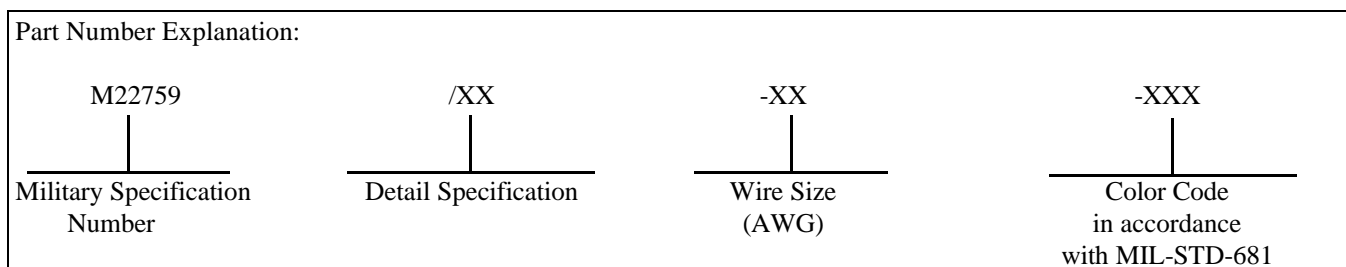

Notes:

1. Flammability properties of these wires are controlled by the applicable specifications. However, applications in Space Transportation System (STS) payloads may require that the specific STS flammability hazards be addressed. Users are advised to consult the appropriate project systems safety officer.
2. Due to the cold flow phenomena of teflon insulation, the designer is advised to not route teflon insulated wires over sharp edges and tight turns, or apply tight stitches and tie wraps to cable assemblies.

**MIL-W-22759 Wire, Extruded PTFE (Note 1)
Fluoropolymer Insulated, 600 Volt**

Conductor			Copper	Copper	High Strength Copper	High Strength Copper
Coating			Silver (Note 2)	Nickel	Silver (Note 2)	Nickel
Max Temperature			200°C	260°C	200°C	260°C
Specification			MIL-W-22759/11	MIL-W-22759/12	MIL-W-22759/22	MIL-W-22759/23
Wire Size, AWG	Stranding (Number of Strands x AWG Size of Strands)	Finished Wire Diameter (Inches)	Part Number (Note 3)	Part Number (Note 3)	Part Number (Note 3)	Part Number (Note 3)
28	7 x 36	0.033 ± 0.002	M22759/11-28-XX	M22759/12-28-XX	M22759/22-28-XX	M22759/23-28-XX
26	19 x 38	0.038 ± 0.002	M22759/11-26-XX	M22759/12-26-XX	M22759/22-26-XX	M22759/23-26-XX
24	19 x 36	0.043 ± 0.002	M22759/11-24-XX	M22759/12-24-XX	M22759/22-24-XX	M22759/23-24-XX
22	19 x 34	0.049 ± 0.002	M22759/11-22-XX	M22759/12-22-XX	M22759/22-22-XX	M22759/23-22-XX
20	19 x 32	0.058 ± 0.002	M22759/11-20-XX	M22759/12-20-XX	M22759/22-20-XX	M22759/23-20-XX
18	19 x 30	0.068 ± 0.002	M22759/11-18-XX	M22759/12-18-XX	X	X
16	19 x 29	0.075 ± 0.002	M22759/11-16-XX	M22759/12-16-XX		
14	19 x 27	0.090 ± 0.002	M22759/11-14-XX	M22759/12-14-XX		
12	19 x 25	0.111 ± 0.003	M22759/11-12-XX	M22759/12-12-XX	X	X
10	37 x 26	0.139 ± 0.004	M22759/11-10-XX	M22759/12-10-XX		
8	133 x 29	0.202 ± 0.004	M22759/11-8-XX	M22759/12-8-XX		

Notes:

- Wire may be used in Grade 1 and 2 applications.
- Silver-coated copper is susceptible to cuprous oxide corrosion ("red plague") when produced, stored or used in a moist or high humidity environment. The environment for this wire must be controlled.
- Part number: The X in the part number column shall be replaced by color code designators in accordance with MIL-STD-681. Refer to page 16-5.
Examples: Size 20, white - M22759/9-20-9; white with orange stripe - M22759/9-20-93.

**MIL-W-22759 Wire, Extruded PTFE (Note 1)
Fluoropolymer Insulated, 1000 Volt**

Conductor			Copper	High Strength Copper
Coating			Silver (Note 2)	Silver (Note 2)
Max Temperature			200°C	200°C
Specification			MIL-W-22759/9	MIL-W-22759/20
Wire Size, AWG	Stranding (Number of Strands x AWG Size of Strands)	Finished Wire Diameter (Inches)	Part Number (Note 3)	Part Number (Note 3)
28	7 x 36	0.043 ± 0.002	M22759/9-28-XX	M22759/20-28-XX
26	19 x 38	0.048 ± 0.002	M22759/9-26-XX	M22759/20-26-XX
24	19 x 36	0.053 ± 0.002	M22759/9-24-XX	M22759/20-24-XX
22	19 x 34	0.060 ± 0.002	M22759/9-22-XX	M22759/20-22-XX
20	19 x 32	0.068 ± 0.002	M22759/9-20-XX	M22759/20-20-XX
18	19 x 30	0.078 ± 0.002	M22759/9-18-XX	
16	19 x 29	0.085 ± 0.002	M22759/9-16-XX	
14	19 x 27	0.100 ± 0.003	M22759/9-14-XX	
12	19 x 25	0.120 ± 0.004	M22759/9-12-XX	
10	37 x 26	0.141 ± 0.004	M22759/9-10-XX	
8	133 x 29	0.207 ± 0.003	M22759/9-8-XX	

Notes:

1. Wire may be used in Grade 1 and 2 applications.
2. Silver-coated copper is susceptible to cuprous oxide corrosion (“red plague”) when produced, stored or used in a moist or high humidity environment. The environment for this wire must be controlled.
3. Part number: The X in the part number column shall be replaced by color code designators in accordance with MIL-STD-681. Refer to page 16-5. Examples: Size 20, white - M22759/9-20-9; white with orange stripe - M22759/9-20-93.

**MIL-W-22759 Wire, Extruded ETFE (Notes 1, 2)
Fluoropolymer Insulated, 600 Volt**

Insulation Thickness Type		Medium Weight		Lightweight	
Conductor		Copper		Copper	
Coating		Tin		Tin	
Max Temperature		+150°C		+150°C	
Specification		MIL-W-22759/16		MIL-W-22759/18	
Wire Size, AWG	Stranding (Number of Strands x AWG Size of Strands)	Part Number (Note 3)	Finished Wire Diameter (Inches)	Part Number (Note 3)	Finished Wire Diameter (Inches)
26	19 x 38	---	---	M22759/18-26-XX	0.032 ± 0.002
24	19 x 36	M22759/16-24-XX	0.045 ± 0.002	M22759/18-24-XX	0.036 ± 0.002
22	19 x 34	M22759/16-22-XX	0.052 ± 0.002	M22759/18-22-XX	0.043 ± 0.002
20	19 x 32	M22759/16-20-XX	0.060 ± 0.002	M22759/18-20-XX	0.051 ± 0.002
18	19 x 30	M22759/16-18-XX	0.071 ± 0.002	M22759/18-18-XX	0.061 ± 0.002
16	19 x 29	M22759/16-16-XX	0.079 ± 0.002	M22759/18-16-XX	0.070 ± 0.002
14	19 x 27	M22759/16-14-XX	0.093 ± 0.002	M22759/18-14-XX	0.085 ± 0.002
12	37 x 28	M22759/16-12-XX	0.114 ± 0.003	M22759/18-12-XX	0.107 ± 0.003
10	37 x 26	M22759/16-10-XX	0.139 ± 0.003	M22759/18-10-XX	0.134 ± 0.003
8	133 x 29	M22759/16-8-XX	0.199 ± 0.003	X	X
6	133 x 27	M22759/16-6-XX	0.250 ± 0.003		
4	133 x 25	M22759/16-4-XX	0.312 ± 0.004		
2	665 x 30	M22759/16-2-XX	0.388 ± 0.004		
1	817 x 30	M22759/16-1-XX	0.431 ± 0.005		
0	1045 x 30	M22759/16-01-XX	0.479 ± 0.006		
00	1330 x 30	M22759/16-02-XX	0.546 ± 0.007		

Notes:

1. Wire may be used in Grade 1 and 2 applications.
2. Some ETFE (Ethylene Tetrafluoroethylene) insulated wire has been found to fail flammability testing in a 30% oxygen environment.
3. Part number: The X in the part number column shall be replaced by color code designators in accordance with MIL-STD-681. Refer to page 16-5. Examples: Size 20, white - M22759/16-20-9; white with orange stripe - M22759/16-20-93.

**MIL-W-22759 Wire, Lightweight, Crosslinked (Notes 1, 2)
ETFE, Fluoropolymer Insulated, 600 Volt**

Conductor			Copper	Copper	Copper	High Strength Copper
Coating			Tin	Silver (Note 3)	Nickel	Silver (Note 3)
Max Temperature			150°C	200°C	200°C	+200°C
Specification			MIL-W-22759/32	MIL-W-22759/44	MIL-W-22759/45	MIL-W-22759/33
Wire Size, AWG	Stranding (Number of Strands x AWG Size of Strands)	Finished Wire Diameter (Inches)	Part Number (Note 4)	Part Number (Note 4)	Part Number (Note 4)	Part Number (Note 4)
30	7 X 38	0.024 ± 0.002	M22759/32-30-XX			M22759/33-30-XX
28	7 x 36	0.027 ± 0.002	M22759/32-28-XX	M22759/44-28-XX	M22759/45-28-XX	M22759/33-28-XX
26	19 x 38	0.032 ± 0.002	M22759/32-26-XX	M22759/44-26-XX	M22759/45-26-XX	M22759/33-26-XX
24	19 x 36	0.037 ± 0.002	M22759/32-24-XX	M22759/44-24-XX	M22759/45-24-XX	M22759/33-24-XX
22	19 x 34	0.043 ± 0.002	M22759/32-22-XX	M22759/44-22-XX	M22759/45-22-XX	M22759/33-22-XX
20	19 x 32	0.050 ± 0.002	M22759/32-20-XX	M22759/44-20-XX	M22759/45-20-XX	M22759/33-20-XX
18	19 x 30	0.060 ± 0.002	M22759/32-18-XX	M22759/44-18-XX	M22759/45-18-XX	X
16	19 x 29	0.068 ± 0.002	M22759/32-16-XX	M22759/44-16-XX	M22759/45-16-XX	
14	19 x 27	0.085 ± 0.003	M22759/32-14-XX	M22759/44-14-XX	M22759/45-14-XX	
12	37 x 28	0.103 ± 0.004	M22759/32-12-XX	M22759/44-12-XX	M22759/45-12-XX	

Notes:

- Wire may be used in Grade 1 and 2 applications.
- Some ETFE (Ethylene Tetrafluoroethylene) insulated wire has been found to fail flammability testing in a 30% oxygen environment.
- Silver-coated copper is susceptible to cuprous oxide corrosion (“red plague”) when produced, stored or used in a moist or high humidity environment. The environment for this wire must be controlled.
- Part number: The X in the part number column shall be replaced by color code designators in accordance with MIL-STD-681. Refer to page 16-5. Examples: Size 20, white - M22759/32-20-9; white with orange stripe - M22759/32-20-93.

**MIL-W-22759 Wire, Normal Weight, Crosslinked (Notes 1, 2)
ETFE Fluoropolymer Insulated, 600 Volt**

Conductor			Copper	Copper	Copper	High Strength Copper
Coating			Tin	Silver (Note 3)	Nickel	Silver (Note 3)
Max Temperature			150°C	2000°C	200°C	200°C
Specification			MIL-W-22759/34	MIL-W-22759/43	MIL-W-22759/41	MIL-W-22759/35
Wire Size, AWG	Stranding (Number of Strands x AWG Size of Strands)	Finished Wire Diameter (Inches)	Part Number (Note 4)	Part Number (Note 4)	Part Number (Note 4)	Part Number (Note 4)
26	19 x 38	0.040 ± 0.002		M22759/43-26-XX	M22759/41-26-XX	M22759/35-26-XX
24	19 x 36	0.045 ± 0.002	M22759/34-24-XX	M22759/43-24-XX	M22759/41-24-XX	M22759/35-24-XX
22	19 x 34	0.050 ± 0.002	M22759/34-22-XX	M22759/43-22-XX	M22759/41-22-XX	M22759/35-22-XX
20	19 x 32	0.058 ± 0.002	M22759/34-20-XX	M22759/43-20-XX	M22759/41-20-XX	M22759/35-20-XX
18	19 x 30	0.070 ± 0.003	M22759/34-18-XX	M22759/43-18-XX	M22759/41-18-XX	X
16	19 x 29	0.077 ± 0.003	M22759/34-16-XX	M22759/43-16-XX	M22759/41-16-XX	
14	19 x 27	0.094 ± 0.003	M22759/34-14-XX	M22759/43-14-XX	M22759/41-14-XX	
12	37 x 28	0.111 ± 0.003	M22759/34-12-XX	M22759/43-12-XX	M22759/41-12-XX	
10	37 x 26	0.134 ± 0.004	M22759/34-10-XX	M22759/43-10-XX	M22759/41-10-XX	
8	133 x 29	0.195 ± 0.008	M22759/34-8-XX	M22759/43-8-XX	M22759/41-8-XX	
6	133 x 27	0.241 ± 0.010	M22759/34-6-XX	M22759/43-6-XX	M22759/41-6-XX	
4	133 x 25	0.310 ± 0.010	M22759/34-4-XX	M22759/43-4-XX	M22759/41-4-XX	

Notes:

- Wire may be used in Grade 1 and 2 applications.
- Some ETFE (Ethylene Tetrafluoroethylene) insulated wire has been found to fail flammability testing in a 30% oxygen environment.
- Silver-coated copper is susceptible to cuprous oxide corrosion ("red plague") when produced, stored or used in a moist or high humidity environment. The environment for this wire must be controlled.
- Part number: The X in the part number column shall be replaced by color code designators in accordance with MIL-STD-681. Refer to page 16-5. Examples: Size 20, white - M22759/34-20-9; white with orange stripe - M22759/34-20-93.

MIL-W-81381 Wire, FEP, Fluorocarbon/Polyimide (Notes 1 through 3) (Page 1 of 2)
Insulated, Copper or Copper Alloy

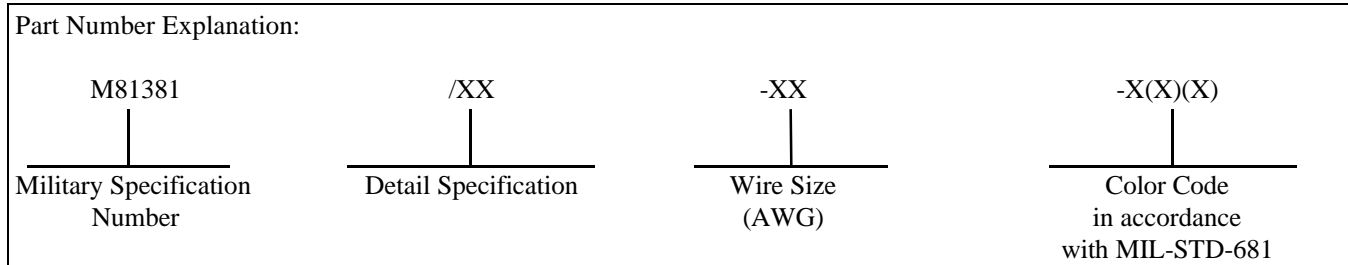

Notes: (Continued on page 16-13)

1. Wire may be used in Grade 1 and 2 applications.
2. Tape code: .1/1/.1=0.1 mil Fluorinated Ethylene Propylene (FEP) fluorocarbon resin/1 mil Polyimide film/0.1 mil FEP fluorocarbon. Minimum overlap 50%.
3. MIL-W-81381 wire may be preferred for its light weight and excellent mechanical, electrical, and radiation resistance properties. However, the insulation of this wire has known reliability problems in certain applications. Extended exposure to moisture or alkaline cleaning chemicals has been shown to degrade the insulation's mechanical strength, resulting in flaking of the outer insulation tape, and cracking from vibration or movement stress when installed around tight radius bends. The resulting degradation may lead to flashover, arc tracking, and shorting, which may ignite the insulation.

MIL-W-81381 Wire, FEP, Fluorocarbon/Polyimide (Notes 1 through 3) (Page 2 of 2)
Insulated, Copper or Copper Alloy

Conductor				Copper	Copper	High Strength Copper	High-Strength Copper	Copper
Coating				Silver (Note 1)	Nickel	Silver (Note 4)	Nickel	Tin
Max Temperature				200°C	200°C	200°C	200°C	150°C
Specification				MIL-W-81381/7	MIL-W-81381/8	MIL-W-81381/9	MIL-W-81381/10	MIL-W-81381/21
Wire Size, AWG	Stranding (Number of Strands x AWG Size of Strands)	Finished Wire Diameter (Inches)		Part Number (Note 5)	Part Number (Note 5)	Part Number (Note 5)	Part Number (Note 5)	Part Number (Note 5, 6)
		Min.	Min.					
30	7 x 38	0.023	0.026	X	X	M81381/9-30-XX	M81381/10-30-XX	X
28	7 x 36	0.026	0.029	X	X	M81381/9-28-XX	M81381/10-28-XX	X
26	19 x 38	0.031	0.034	M81381/7-26-XX	M81381/8-26-XX	M81381/9-26-XX	M81381/10-26-XX	M81381/21-26-XX
24	19 x 36	0.034	0.037	M81381/7-24-XX	M81381/8-24-XX	M81381/9-24-XX	M81381/10-24-XX	M81381/21-24-XX
22	19 x 34	0.041	0.044	M81381/7-22-XX	M81381/8-22-XX	M81381/9-22-XX	M81381/10-22-XX	M81381/21-22-XX
20	19 x 32	0.049	0.052	M81381/7-20-XX	M81381/8-20-XX	M81381/9-20-XX	M81381/10-20-XX	M81381/21-20-XX
18	19 x 30	0.059	0.062	M81381/7-18-XX	M81381/8-18-XX	X	X	M81381/21-18-XX
16	19 x 29	0.065	0.068	M81381/7-16-XX	M81381/8-16-XX	X	X	M81381/21-16-XX
14	19 x 27	0.078	0.082	M81381/7-14-XX	M81381/8-14-XX	X	X	M81381/21-14-XX
12	37 x 28	0.097	0.101	M81381/7-12-XX	M81381/8-12-XX	X	X	M81381/21-12-XX
10	37 x 26	0.127	0.124	M81381/7-10-XX	M81381/8-10-XX	X	X	M81381/21-10-XX

Notes:

4. Silver-coated copper is susceptible to cuprous oxide corrosion (“red plague”) when produced, stored or used in a moist or high humidity environment. The environment for this wire must be controlled.
5. Part number: The color code suffix shall be replaced by color code designators in accordance with MIL-STD-681 except that opaque dark yellow as defined in MIL-W-81381 shall be designated by the letter N, and unpigmented polyimide resin insulation shall be designated by the letter C. Examples: Size 20, opaque dark yellow - M81381/9-20-N; same with orange stripe - M81381/9-20-N3. Unpigmented insulation is preferred (no modified aromatic polyimide resin coating). Refer to page 16-5 for a listing of MIL-STD-681 color coding.
6. For MIL-W-81381/21 finished wire diameter, 24 AWG through 10 AWG, add 0.001 to the value shown.

**GSFC S-311-P-13 Wire, High Voltage, Crosslinked Polyalkene Over Crosslinked PVDF Insulation, (Notes 1, 2)
Tin Coated Copper, 135°C**

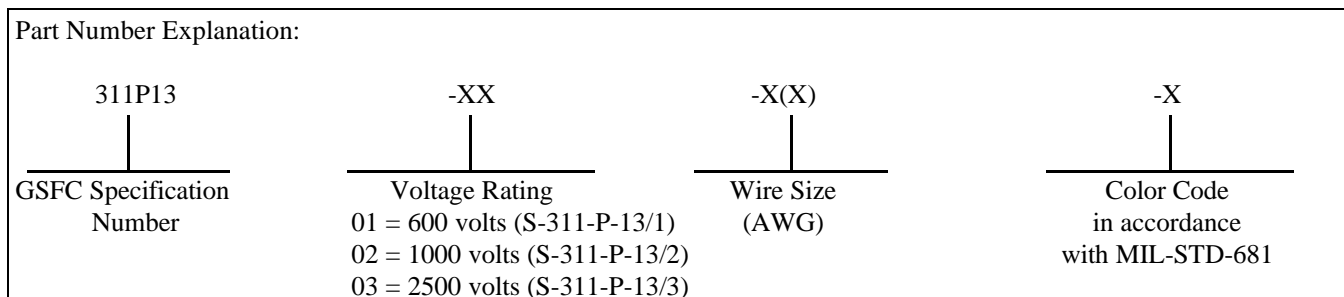

Type Destination	Wire Size, AWG	600 Volt			1000 Volt			2500 Volt		
		Stranding (Number of Strands x AWG Size of Strands)	Finished Wire Diameter (max)		Stranding (Number of Strands x AWG Size of Strands)	Finished Wire Diameter (max)		Stranding (Number of Strands x AWG Size of Strands)	Finished Wire Diameter (max)	
			In.	(mm)		In.	(mm)		In.	(mm)
311P13-XX-30-X	30	7 x 38	0.028	(.71)	---	---	---	---	---	---
311P13-XX-28-X	28	7 x 36	0.031	(.79)	7 x 36	0.034	(.86)	---	---	---
311P13-XX-26-X	26	7 x 34	0.035	(.89)	7 x 34	0.041	(1.08)	---	---	---
311P13-XX-24-X	24	19 x 36	0.041	(1.04)	19 x 36	0.046	(1.17)	19 x 36	0.059	(1.50)
311P13-XX-22-X	22	19 x 34	0.048	(1.22)	19 x 34	0.053	(1.35)	19 x 34	0.071	(1.80)
311P13-XX-20-X	20	19 x 32	0.056	(1.42)	19 x 32	0.061	(1.55)	19 x 32	0.080	(2.03)
311P13-XX-18-X	18	19 x 30	0.066	(1.68)	19 x 30	0.074	(1.88)	19 x 30	0.090	(2.29)
311P13-XX-16-X	16	19 x 29	0.074	(1.88)	19 x 29	0.082	(2.08)	19 x 29	0.100	(2.54)
311P13-XX-14-X	14	19 x 27	0.090	(2.29)	19 x 27	0.098	(2.49)	19 x 27	0.118	(3.00)
311P13-XX-12-X	12	37 x 28	0.122	(2.84)	19 x 25	0.127	(3.23)	19 x 25	0.148	(3.71)
311P13-XX-10-X	10	---	---	---	37 x 26	0.142	(3.61)	37 x 26	0.165	(4.19)
311P13-XX-8-X	8	---	---	---	133 x 29	0.208	(5.28)	133 x 29	0.228	(5.79)
311P13-XX-6-X	6	---	---	---	---	---	---	133 x 27	0.278	(7.06)
311P13-XX-4-X	4	---	---	---	---	---	---	133 x 25	0.336	(8.53)
311P13-XX-2-X	2	---	---	---	---	---	---	665 x 30	0.398	(10.1)
311P13-XX-0-X	0	---	---	---	---	---	---	1045 x 30	0.448	(12.4)
311P13-XX-00-X	00	---	---	---	---	---	---	1330 x 30	0.560	(14.2)

Notes:

1. For use in Grade 1 and 2 applications.
2. Primary insulation is crosslinked extruded Polyalkene. Jacket is crosslinked extruded PVDF.

MIL-C-27500 Multiconductor Cable, Shielded and Unshielded, Jacketed and Unjacketed (Note 1)

Part number explanation (Note 2).						
<u>M27500</u>	<u>X</u>	<u>XX</u>	<u>XX</u>	<u>X(X)</u>	<u>X</u>	<u>XX</u>
Military Specification <u>Number</u>	<u>Braid Coverage</u>	<u>Wire AWG</u>	<u>Basic Wire Insulation Type</u>	<u>No. Of Wires</u>	<u>Shield Style and Material</u>	<u>Outer Jacket</u>
	- = 85% C = 90% (Note 3)	26 thru 2/0 (All conductors are same AWG)	(Note 4) <u>PTFE Teflon</u> LE=Mil-W-22759/9 RC=Mil-W-22759/11 RE=Mil-W-22759/12 TK=Mil-W-22759/20 TM=Mil-W-22759/22 TN=Mil-W-22759/23 <u>ETFE</u> TE=Mil-W-22759/16 TG=Mil-W-22759/18 <u>Crosslinked ETFE</u> SB=Mil-W-22759/32 SM=MIL-W-22759/41 SC=Mil-W-22759/33 SP=MIL-W-22759/43 SD=Mil-W-22759/34 SR=MIL-W-22759/44 SE=Mil-W-22759/35 SS=MIL-W-22759/45	1 thru 10 (Note 5)	Round Shield with normal strength copper strands (Note 6) U = No Shield <u>Single Shield</u> S=Silver T= Tin <u>Double Shield</u> W=Silver V=Tin	00=No Jacket <u>Single Jacket</u> 06=PTFE Teflon (White) 09=FEP Teflon (White) 23=Crosslinked ETFE (White) <u>Double Jacket (Note 7)</u> 59=FEP Teflon (White) 73=Crosslinked ETFE (White)

Notes:

1. Cable may be used in Grade 1 or Grade 2 applications.
2. Part number explanation is for preferred construction. Use M22759/11 (Symbol RC) or M22759/33 (Symbol SC) for base wire with silver coated copper single shield (Symbol S) and FEP teflon single jacket (Symbol 09) as first choice. Other options are shown on page 16-3. Example of complete part number with above options for three #22 AWG conductors: M27500-22RC3S09 or M27500-22SC3S09. Consult MIL-C-27500 for other options.
3. Designation shown for braid coverage includes preferred conductor identification method (white base color with color spiral stripe.) Optional solid identification color coding is available.
4. Basic wire types are for preferred MIL-W-22759 wire contained in this section.
5. Single conductor cable must be shielded and/or jacketed. Otherwise, use one of the basic wire types listed in this section.
6. Flat style shield and other shield materials are available. Consult MIL-C-27500.
7. The double jacket symbol shall only be used in conjunction with a double shield symbol. The first jacket appears between the two shields and the second jacket over the outer shield. Both jackets are the same material.

MIL-C-17 Radio Frequency Coaxial Cable, Flexible and Semi-Rigid (Notes 1, 2)

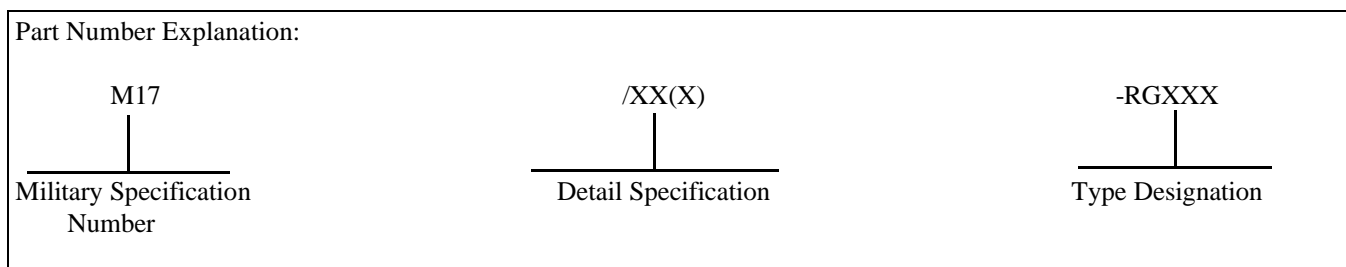

Generic Type Designation	Part Number	Type	Impedance (Ohms)	Operating Frequency Max (Ghz)	Working Voltage Max (Vrms)	Shielding	Connector Accommodation Series	Temperature Range	Capacitance, Max (pF/ft)	Diameter (Inches)	
										Min	Max
RG142/U	M17/60-RG142	Flexible	50 ± 2	12.4	1,400	Double Braid	SMA,TNC,N	-55°C to +200°C	29.3 nominal	0.190	0.20
RG178/U	M17/93-RG178		50 ± 2	3	750	Single Braid	SMA		32	0.067	0.075
RG180/U	M17/95-RG180		95 ± 5	3	1,100	Single Braid	SMA (Note 3, 4)		17.4	0.137	0.145
RG302/U	M17/110-RG302		75 ± 3	3	1,700	Single Braid	SMA (Note 3, 4)		22	0.197	0.207
RG303/U	M17/111-RG303		50 ± 2	3	1,400	Single Braid	SMA, TNC		32	0.165	0.175
RG316/U	M17/113-RG316		50 ± 2	3	900	Single Braid	SMA,TNC		32	0.094	0.102
RG393/U	M17/127-RG393		50 ± 2	11	1,875	Double Braid	SMA (Note 3)		32	0.380	0.400
RG400/U	M17/128-RG400		50 ± 2	12.4	1,400	Double Braid	SMA,TNC,N		32	0.190	0.200
----	M17/152-00001		50 ± 2	12.4	900	Double Braid	SMA		32	0.110	0.118
RG402/U	M17/130-RG402		Semi-Rigid	50 ± 1	20	1,900	Copper Tubing		SMA	-40°C to +125°C	29.9
RG405/U	M17/133-RG405	50 ± 1.5		20	1,500	Copper Tubing	SMA	32	0.0855		0.0875

Notes:

1. For use in Grade 1 and 2 applications.
2. All cable has solid PTFE dielectric core. Flexible cable has FEP jacket. Semi-rigid cable outer conductor (shield) is bare copper.
3. Accommodating preferred connector is 50 ohm SMA soldercup type.
4. There are no 75 ohm or 95 ohm impedance connectors to accommodate this cable. Due to impedance mismatch, performance ratings are not applicable.

J-W-1177 Magnet Wire (Notes 1, 2)

Part Number Explanation:				
M1177	/X(X)	02	C	0XX
Federal Specification Number	Detail Specification Number	Two Digit Type Code 02 - Heavy Insulation	Single Letter Conductor Code C - Copper	Three Digit Size Code (Use AWG size of bare wire preceded by appropriate number of zeros)

Specification		J-W-1177/9 (Notes 3, 4)		J-W-1177/12		J-W-1177/14		J-W-1177/15	
Temperature Class (°C)		130		180		200		220	
Insulation Coating		Solderable Polyurethane Overcoated with Polyamide, Round		Polyester-Imide or Polyester-Amide-Imide, Round		Polyester, Polyester-Imide or Polyester-Amide-Imide, Overcoated with Polyamide-Imide, Round		Polyimide-Coated, Round	
AWG	Maximum Overall Diameter (inches)	Part Number	Minimum Breakdown Voltage (volts)	Part Number	Minimum Breakdown Voltage (volts)	Part Number	Minimum Breakdown Voltage (volts)	Part Number	Minimum Breakdown Voltage (volts)
14	0.0682	M1177/9-02C014	5700	M1177/12-02C014	6325	M1177/14-02C014	6325	M1177/15-02C014	6325
16	0.0545	M1177/9-02C016	5400	M1177/12-02C016	6000	M1177/14-02C016	6000	M1177/15-02C016	6000
18	0.0437	M1177/9-02C018	5125	M1177/12-02C018	5700	M1177/14-02C018	5700	M1177/15-02C018	5700
20	0.0351	M1177/9-02C020	4850	M1177/12-02C020	5400	M1177/14-02C020	5400	M1177/15-02C020	5400
22	0.0281	M1177/9-02C022	4625	M1177/12-02C022	5125	M1177/14-02C022	5125	M1177/15-02C022	5125
24	0.0227	M1177/9-02C024	4375	M1177/12-02C024	4850	M1177/14-02C024	4850	M1177/15-02C024	4850
26	0.0182	M1177/9-02C026	4150	M1177/12-02C026	4600	M1177/14-02C026	4600	M1177/15-02C026	4600
28	0.0147	M1177/9-02C028	3950	M1177/12-02C028	4375	M1177/14-02C028	4375	M1177/15-02C028	4375
30	0.0119	M1177/9-02C030	3725	M1177/12-02C030	4150	M1177/14-02C030	4150	M1177/15-02C030	4150
32	0.0098	M1177/9-02C032	3175	M1177/12-02C032	3525	M1177/14-02C032	3525	M1177/15-02C032	3525
34	0.0078	M1177/9-02C034	2675	M1177/12-02C034	2975	M1177/14-02C034	2975	M1177/15-02C034	2975
36	0.0063	M1177/9-02C036	2275	M1177/12-02C036	2525	M1177/14-02C036	2525	M1177/15-02C036	2525
38	0.0051	M1177/9-02C038	1925	M1177/12-02C038	2150	M1177/14-02C038	2150	M1177/15-02C038	2150
40 (Note 2)	0.0040	M1177/9-02C040	1625	M1177/12-02C040	1800	M1177/14-02C040	1800	M1177/15-02C040	1800
42 (Note 2)	0.0032	M1177/9-02C042	1375	M1177/12-02C042	1525	M1177/14-02C042	1525	M1177/15-02C042	1525
44 (Note 2)	0.0027	M1177/9-02C044	1175	M1177/12-02C044	1300	M1177/14-02C044	1300	M1177/15-02C044	1300

Notes:

1. Magnet wire is intended for use in magnetic devices, rotating equipment and similar applications where a tough film-type insulation providing adequate mechanical protection is desired.
2. For Grade 1 programs, only wire sizes 14 through 38 are acceptable.
3. Some QPL suppliers of J-W-1177/9 substitute /42 wire when /9 is ordered. The /42 wire has a temperature rating of 155°C. This substitution is acceptable to GSFC.
4. Due to outgassing concerns of the Nylon coating, M1177/9 wire and M1177/42 wire may not be acceptable for devices with open type construction.

THIS PAGE INTENTIONALLY LEFT BLANK

Summary of Preferred Crystal Oscillators

Control Specification	Description	Frequency Range (Hz)	Grade 1	Grade 2	Refer to Page No.
MIL-O-55310	Crystal Oscillators, Type 1	0.1 to 60M	S	B	17-2

MIL-O-55310, Crystal Oscillators (Page 1 of 2)

Part Number Explanation				
M55310/XX-	X	XX	X	XXXXXXXX
Military Specification and Slash Sheet Number	Product Assurance Level S = Class S B = Class B	Dash Number uniquely identifies performance characteristics	Operating Temperature Range (Note 1) A = -55°C to +125°C B = -55°C to + 105°C	Oscillator Frequency identified by seven digits and a letter (H, K, or M) (Note 2)

Military Part Number (Note 3)	Classification	Output Frequency Range (Note 4)	Max. Input Current Range @5.25V (ma)	Output Voltage		Rise and Fall Time Range (max) (ns)	Frequency Stability (PPM)		Grade 1	Grade 2
				Logic 1 (Vdc)	Logic 0 (Vdc)		-55°C to +125C	-55C to +105°C		
M55310/08-XXXX	Type 1, Hybrid Construction, Square Wave, TTL Compatible, 14 PIN DIP	50Hz to 50Mhz	25 - 158						S	B
M55310/14-XXXX		0.1Hz to 25MHz	20 - 158	2.4	0.5	5 to 15	± 50	± 40	(Note 5)	B
M55310/16-XXXX		0.1Hz to 60MHz	30 - 158						S	B

Notes:

- Temperature range A is available only for Class B oscillators.
- The letters "H", "K", "M" represent the decimal point for oscillator frequencies as follows:
 H - between 1 and 1000Hz, expressed in Hz.
 K - between 1KHz and 1MHz, expressed in KHz
 M - equal to or greater than 1MHz, expressed in MHz.
- The military part number and the specified nominal frequency (8 characters) define an item of supply.
- The frequency currently available for class S, / 08 oscillator is 512Hz through 1KHz only. The minimum frequency available for Class S, / 16 oscillators is 16khz.
- There are currently no Class S, /14 oscillators available.

Optoelectronic Parts

There are no optoelectronic parts that meet the preferred parts criteria specified herein. The listed parts have been evaluated by the GSFC Parts Branch, and/or have been used successfully in GSFC flight projects, and are provided for information. Lot qualification and 100% screening tests should be developed and performed on these parts prior to flight usage, and derating criteria should be determined. Recommended screening tests are included in Appendix C. In all cases, a good understanding of photonic part integration is essential.

Summary of Optoelectronic Parts

Specification	Part Number	Description	Refer to Page No.
S-311-P-339/1	G311P339/1-1	Cable, Fiber Optic, Single Channel, Multimode	51-2
MIL-C-83522/2	M83522/2-04	SMA Connector	51-3
MIL-C-83522/3	M83522/3-01	SMA Coupling Bushing	
Commercial	501054	SMA Active Device Mount	
MIL-T-29504/4	M29504/4-4044	Termini, Fiber Optic, Pin	51-4
MIL-T-29504/5	M29504/5-4050	Termini, Fiber Optic, Socket	
S-311-P-762/1	G311P762/1	Transmitter, Digital Integrated, Fiber Optic, TTL	51-5
S-311-P-763/1	G311P763/1	Receiver, Digital Integrated, Fiber Optic, TTL	
		Transceiver, Fiber Optic, MIL-STD-1773 Interface	
S-311-P-614/1	G311P614/1-X	Coupler, Fiber Optic, Passive Star	51-6
MIL-S-19500/519	JANTX1N6609	LED (Red)	51-6
MIL-S-19500/520	JANTX1N6610	LED (Yellow)	51-6
MIL-S-19500/521	JANTX1N6611	LED (Green)	51-6

Cable, Fiber Optic, Single Channel, Multimode (Notes 1 through 5)

Part Number	Manufacturer Part Number	Attenuation (maximum)	Manufacturer
G311P339/1-1	OC-1008	10 dB/km	Brand-Rex

Notes:

1. G311P339/1-1 cable contains a single 100/140 um size, graded index, optical fiber (Corning SDF) with a double layer acrylate coating. It is a “semi-loose” tube buffered with a flame retardant polyester elastomer material, contains Teflon™ Impregnated fiberglass strength members, and is jacketed in ETFE. The temperature rating is –55°C to 85°C, limited by the acrylate fiber coating.
2. Flammability properties for this cable are controlled by the GSFC specification for ground based levels of oxygen concentrations or lower. When application conditions expose these parts to pure oxygen levels in excess of 20%, additional flammability hazard analyses should be performed.
3. The manufacturer’s part number listed is for reference only. Part procurement shall be in accordance with GSFC specification S-311-339.
4. The ETFE cable jacket has been shown to meet GSFC outgassing requirements.
5. Additional radiation tolerant, high temperature cables are being considered for listing in this standard. Contact Code 311 regarding the suitability of cable types not shown here, or to recommend fiber and cable for evaluation testing.

Connector, Fiber Optic, Single Channel (Notes 1 through 5)

Part Description	Part Number	Specification	Manufacturer's Part Number	Insertion Loss (maximum)
SMA Connector	M83522/2-04	MIL-C-83522/2	504019-2	With coupling bushing: 3dB per pair With device mount: 2 dB
SMA Coupling Bushing	M83522/3-01	MIL-C-83522/3	504020-1	See above
SMA Active Device Mount	none	none	501054	See above

Notes:

1. This connector is for use with 100/140 μm size fiber and has use history with the GSFC-S-311-339 cable. Amp Incorporated is the only qualified supplier for the military part at this time. The device mount, necessary to most optical systems involving SMA connectors, is not shown on the current QPL-83522. The Amp product is recommended here because it will ultimately be the most compatible with the corresponding Amp connector. However, SMA device mounts are available from a variety of commercial sources.
2. This connector is considered high loss with respect to available commercial designs for single fiber connectors. It is a non-keyed, non-contact connector and can show insertion loss variability (up to 1.5 dB) with every break-and-mate action. Use of a 4 in-lb torque wrench during mating may reduce some of this variability.
3. Flight connector coupling rings should be staked in place to reduce any backing off of the connector with excessive exposure to vibration and eliminate unnecessary breaking of the connection.
4. The preferred epoxy for use with this connector is Trabond BA-F253 (as opposed to the types listed in the military specification). Use of TRMM-733-192, Optical Fiber Cable Termination Procedure for MIL-C-83522/2 Optical Fiber Connectors is recommended when using these connectors.
5. The Parts Branch is investigating qualification of less lossy single fiber connectors for future use by GSFC projects. Please contact the Parts Branch for information regarding other single fiber connectors or to make suggestions in this regard.

Termini, Fiber Optic, Multichannel (Notes 1, 2)

Part Number	Manufacturer Part Number	Specification	Insertion Loss (dB)
M29504/4-4044	CF-19803-17 (Pin)	MIL-T-29504/4	2
M29504/5-4050	CF-198035-17 (Socket)	MIL-T-29504/5	

Notes:

1. The multi-termini connector system comprised of these termini and MIL-C-38999 or commercial type miniature circular electrical connectors has not been space qualified for Grade 1 or Grade 2 programs. Limited experience with this assembly indicates that it suitable for higher risk, short life missions such as Class C or D programs. These fiber optic termini are defined for use with MIL-C-38999, Series I, III and IV connectors, though they are considered non-standard configurations. Trial use by avionics equipment manufacturers and GSFC indicates that great care must be taken to protect the optical contacts from mechanical abrasion and sources of contamination (including greatly limiting the number of mating actions). This is critical for these physical contact terminations. Selection of a "self-bottoming, self-locking" MIL-C-38999 design may reduce alignment sleeve fretting during exposure to high vibration (Consult the manufacturer to determine if their design meets this criteria). Backshells with an auxilliary grommet should be used rather than one with a saddle clamp. Correct insertion tools, designed for these contacts, must be used and care must be taken to avoid damage to the pin termini surface when inserting them into the receptacle half of the connector.
2. Trabond BA-F253 epoxy shall be used for termini/fiber assembly. Use of TRMM-733-190, Optical Fiber Cable Termination Procedure for Space Flight Applications using MIL-T-29504 Optical Termini is recommended when using these termini.

Transmitter, Digital Integrated, Fiber Optic, TTL (Notes 1 through 3)

Part Number	Manufacturer Part Number (Notes 1, 2)	Manufacturer	Light Power Coupled to Fiber (Note 3)	Output Wavelength	Vcc	Icc
G311P762/1	HFE4811-014	Honeywell	100 μ W	850 nm	5.0 V	65 mA

Notes:

1. This part has been used in flight hardware by several GSFC projects and may be suitable for future applications. Its usage history indicates that each flight lot should be qualified separately, and all parts shall be 100% screened in accordance with the requirements of S-311-P-762/1.
2. The emitter used in this transmitter is the HFE4010-014 and may be bought as an individually packaged device.
3. 100/140 μ m size fiber with NA=0.29 (see S-311-339/1-1).

Receiver, Digital Integrated, Fiber Optic, TTL (Notes 1, 2)

Part Number	Manufacturer Part Number (Note 1)	Manufacturer	Sensitivity	Vcc	Icc
G311P763/1	HFE3801-002	Honeywell	1 μ W	5.0 V	20 mA

Notes:

1. This part has been used in flight hardware by several GSFC projects and may be suitable for future applications. Its usage history indicates that each flight lot should be qualified separately, and all parts shall be 100% screened in accordance with the requirements of S-311-P-763. The requirements of S-311-200, General Requirements for Hybrid Microcircuits, shall apply.
2. The detector used in this transmitter is the HFD3000-002 and may be bought as an individually packaged device.

Transceiver, Fiber Optic, MIL-STD-1773 Interface

Fiber optic transceivers for use with MIL-STD-1773 databus applications have been used by several GSFC projects in the past. This part is currently being redesigned by the manufacturer, SCI Systems Inc. Please contact the Parts Branch for information about the availability of this part or replacement options.

Coupler, Fiber Optic

Part Number	Attenuation (Max)	Manufacturer	Manufacturer Part Number
G311P614/1-X (Note 1)	16 dB	Canstar	SFC-C-20X20-S20

Notes:

1. Based on the GSFC evaluation, couplers with two to 10 fused fibers (four to 20 ports) may be specified.

Diodes, Light Emitting (LEDs)

MIL-S-19500 Part Number	MIL-S-19500 Slash Sheet	Relative Light Power Output (Minimum)	Wavelength (Color)
JANTX1N6609	/519	120 mW ($I_{FMAX} = 35mA$)	Red
JANTX1N6610	/520	120 mW ($I_{FMAX} = 35mA$)	Yellow
JANTX1N6611	/521	120 mW ($I_{FMAX} = 35mA$)	Green

Table 01 Additional Testing Requirements for Preferred Capacitors

Inspection/Test	Test Methods, Conditions and Requirements	MIL-C-20		MIL-C-39003		MIL-C-55681	
		Grade 1	Grade 2	Grade 1	Grade 2	Grade 1	Grade 2
Humidity, Steady State, Low Voltage	MIL-C-123, Table XI, Group B, Subgroup 2.	12 (0)				12 (0)	
Surge Current	MIL-C-39003/10			100% (Note 1)			
Destructive Physical Analysis	MIL-C-123, Table X, Group A, Subgroup 3	5 (0)				5 (0)	

Notes:

1. Required for styles CSR09, CSR13, CSR21 and all CWR styles.

Table 02 Additional Testing Requirements for Preferred Connectors (Note 1) (Page 1 of 3)

Inspection/ Test	Test Methods, Conditions and Requirements	Connector Type/Grade Level							
		Circular		D-Subminiature		Microminiature		Printed Circuit	
		1	2	1	2	1	2	1	2
Visual Inspection	Verify proper marking, free of workmanship defects in accordance with Table 02A. 3X magnification (min.) and high intensity lighting.	X	X	X	X	X	X	X	X
Mechanical Inspection	Verify design, construction, dimensions, materials and finish.	X	2 (0)	X	2 (0)	X	2 (0)	X	2 (0)
Dielectric Withstanding Voltage (Sea Level)	MIL-STD-1344, Method 3001. Refer to reference specifications for voltages, mating requirements.	X		X		X (Note 3)		X	
Insulation Resistance	MIL-STD-1344, Method 3003, Condition B. 5000 megohms min. in accordance with reference specifications.	X		X		X		X	
Outgassing Control (As required)	(Note 4)	X	X			X	X		
Hermeticity (Sealed Receptacles Only)	MIL-STD-1344, Method 1008, Pressure as specified.	X	2 (0)						

See notes on page A-4.

Table 02 Additional Testing Requirements for Preferred Connectors (Note 1) (Page 2 of 3)

Inspection/ Test	Test Methods, Conditions and Requirements	Connector Type/Grade Level							
		Radio Frequency		Contacts		EMI Filter Pin		High Voltage	
		1	2	1	2	1	2	1	2
Visual Inspection	Verify proper marking, free of workmanship defects in accordance with Table 02A. 3X magnification (min.) and high intensity lighting.	X	X	X	X	X	X	X	X
Mechanical Inspection	Verify design, construction, dimensions, materials and finish.	X	2 (0)	X	2 (0)	X	1(0)	X	2 (0)
Dielectric Withstanding Voltage (Sea Level)	MIL-STD-1344, Method 3001. MIL-STD-202, Method 301 for RF connectors. Refer to reference specifications for voltages, mating requirements.	2 (0) (Note 5)		2 (0) (Note 6)		X (Note 7)		X (Note 8)	
Insulation Resistance	MIL-STD-202, Method 302 for RF connectors and filter pins. 5000 megohms min. in accordance with reference specifications.	2 (0)				X			
Outgassing Control (As required)	(Note 4)	X	X	X	X	X	X	X	X
Hermeticity (Sealed Receptacles Only)	MIL-STD-202, Method 112, Condition C, Procedure III. Pressure as specified.	X							

See notes on page A-4.

Table 02 Additional Testing Requirements for Preferred Connectors (Page 3 of 3)

Notes:

1. An "X" in the table indicates that the inspection/test is to be performed on a 100% basis. Y (0) indicates the quantity (accept number) for sample testing. If a failure occurs during sample testing, the tests shall either be performed on a 100% basis or the sample size shall be tripled and the tests repeated. If a failure occurs during the second sample test, the lot shall be rejected. 100% examination may be performed at the user's receiving and inspection facilities in lieu of performance by the manufacturer.
2. Required only for MIL-C-26482 and MIL-C-5015 connectors.
3. For MIL-C-83513 microminiature connectors with crimp type pig tail leads, adjacent leads shall be tested for shorting prior to DWV. Each lead shall be tested. A test potential of 600 VRMS (Sea Level) shall be used. If manufacturer can certify that this test is normally performed on each connector, additional testing is not required.
4.
 - a. The user may process connectors for outgassing control by removing and replacing lubricant with a low outgassing lubricant followed by a bakeout of 24 hours at 125°C. Low outgassing lubricants as well as other acceptable variations of bakeout time, temperature, and vacuum for outgassing control are contained in NASA Reference publication 1124. Since removal and replacement of lubricant requires disassembly and is labor intensive, it is recommended that this processing be performed by the manufacturer on connectors procured to a controlled specification.
 - b. Microminiature receptacles contain a fluorosilicone or silicone rubber interface seal. Silicone rubber seals may be an outgassing concern. The interface seal can be carefully removed with small tweezers and discarded. Otherwise, a bakeout of 24 hours at 125°C is recommended to control outgassing.
 - c. Type SMA RF connector plugs may contain a silicone rubber O-Ring interface seal inside the coupling nut, on the mounting flange or inside the cable nut, and require either replacement with flurosilicone O-Rings or a 125°C bakeout for 24 hours to prevent outgassing.
 - d. High voltage panel mount receptacle connectors contain a small silicone rubber grommet which surrounds the center pin contact. This grommet is an outgassing concern, and a bakeout of 125°C is recommended for outgassing control.
5. For coaxial connectors, the connector shall be terminated to the appropriate coaxial cable, and the applied voltage shall be as specified in the detail specification.
6. For coaxial contacts, the dielectric withstanding voltage test shall be performed in accordance with MIL-STD-1344, Method 3001. A voltag of 1000 VRMS (Sea Level) shall be applied between inner contact and shell.
7. For filter pin connectors, dielectric withstanding voltage of twice the rated dc voltage shall be applied for five to ten seconds between each contact and the shell. Current shall be limited to 20 milliamps.
8. High voltage connectors have voltage ratings in excess of 5KV and are similar to Reynolds part numbers 167-3770 and 167-3771. For high voltage connectors rated at 10KVDC, a potential of 15KVDC shall be applied to each connector for 10 seconds, minimum.

Table 02A Inspection Criteria for Connectors and Contacts (Note 1)

DEFECT	Circulars	DSUBS	Micro-miniature	PC	RF	Contacts	RF Contacts	Filter Pin	High Voltage
INSERT	X	X	X	X	X		X	X	X
Insert to Shell Positioning and Orientation	X	X	X		X		X	X	X
Cracks, Chips	X	X	X	X	X		X	X	X
Marking				X				X	
Negative Meniscus of Glass (Hermetics only-glass to contact and glass to shell)	X	X			X				
GROMMET	X								X
Nicks, Gouges, Tears, Folds	X								X
Marking	X		X						
SHELLS	X	X	X		X	X	X	X	X
Cracks, Dents, Scratches	X	X	X		X	X	X	X	X
Finish (Peeled or blistered plating, discoloration, exposed base metal)	X	X	X		X	X	X	X	X
Marking Completeness, Legibility	X	X	X		X	X	X	X	
Sleeves (Fixed - Not free to move)					X	X	X		
THREADS (As Applicable)	X				X				X
Nicks, Dents, Voids	X				X				X
ADHESIVES	X	X	X	X	X			X	X
Excess Bonding Material (Overflow)	X	X	X	X	X			X	X
Voids	X	X	X	X	X			X	X

See notes on page A-4.

Table 04 Additional Testing Requirements for Preferred FM08/FM04 Fuses

Inspection/Test	Test Methods, Conditions, and Requirements	Notes
Visual Inspections	Materials, design, construction, marking, and workmanship	
Resistance (Cold)	MIL-STD-202, Method 303 Resistance to specification	1
Voltage Drop (Hot-1)	100% rated current for 5 minutes (minimum) Voltage drop to specification (when specified)	2
Thermal Shock	MIL-STD-202, Method 107 Condition B	3, 4
Voltage Drop (Hot-2)	100% rated current for 5 minutes (minimum) Ratio voltage drop: (Hot-1/Hot-2) = 0.97 to 1.03	
Resistance (Cold)	MIL-STD-202, Method 303 Resistance to specification	1
Seal	MIL-STD-202, Method 112 Test Condition A	

Notes:

1. The source current for the resistance measurement shall not exceed 10% of the nominal current rating at room temperature.
2. The voltage drop (hot) measurement must be recorded to calculate the voltage drop ratio regardless of whether or not it is a specification requirement.
3. Fuses rated at < +125°C shall be tested to Condition A.
4. External visual examination is required after testing to verify no evidence of mechanical damage.

Table 07 Additional Testing Requirements for Preferred M83401 Resistor Networks

Inspection	Method	Requirement
Thermal Shock	MIL-R-83401 Para. 4.6.3	MIL-R-83401 Para. 3.7
Power Conditioning	MIL-R-83401 Para. 4.6.4 The following exception shall apply: burn-in time = 150 hours minimum	MIL-R-83401 Para. 3.8
DC Resistance		ΔR and final resistance to specification per paras. 3.8 and 3.9 of MIL-R-83401

Table 08 Additional Testing Requirements for Preferred Diodes (Note 1)

Inspection/Test	Test Methods, Conditions, and Requirements	Sample Size	
		Grade 1	Grade 2
PIND (Note 2)	MIL-STD-750, Method 2052, Condition A	Not Required for JAN S	100%

Notes:

1. Not required for non-cavity parts
2. When procured directly from the manufacturer with PIND testing in accordance with Paragraph 4.6.3.4 of MIL-S-19500, additional testing is not required.

Table 09 Additional Testing Requirements for Preferred Transistors

Inspection/Test	Test Methods, Conditions, and Requirements	Sample Size	
		Grade 1	Grade 2
PIND (Note 1)	MIL-STD-750, Method 2052, Condition A	Not Required for JAN S	100%

Notes:

1. When procured directly from the manufacturer with PIND testing in accordance with Paragraph 4.6.3.4 of MIL-S-19500, additional testing is not required.

Table 10 Additional Testing Requirements for Preferred Microcircuits

Inspection/Test	Test Methods, Conditions, and Requirements	Sample Size	
		Grade 1	Grade 2
PIND	MIL-STD-883, Method 2020, Condition A	Not Required for Class S, V, K	100%

Table 17 Additional Testing Requirements for Preferred Crystal Oscillators

Inspection/Test	Test Methods, Conditions, and Requirements	Sample Size	
		Grade 1	Grade 2
PIND	MIL-STD-883, Method 2020, Condition B	Note 1	100%
Radiographic Inspection	MIL-STD-202, Method 209, 1 view in Y Direction, 2nd view 90° relative to first view	Note 1	100% Note 2
Internal Water Vapor Content	MIL-STD-883, Method 1018	3 (0) or 5 (1)	3 (0) or 5 (1)

Notes:

1. Not required for MIL-O-55310 Class S Oscillators. Tests are performed in screening.
2. Not required for devices of discrete component construction.

Table 01 Capacitor Derating Criteria

Voltage derating is accomplished by multiplying the maximum operating voltage by the appropriate derating factor appearing in the chart below.

Type	Military Style	Voltage Derating Factor	Maximum Ambient Temperature
Ceramic	CCR, CKS, CKR, CDR (Note 1)	0.60	110°C
Glass	CYR	0.50	110°C
Plastic Film	CRH, CHS	0.60	85°C
Tantalum, Foil	CLR25, CLR27, CLR35, CLR3	0.5	70°C
Tantalum, Wet Slug	CLR79, CLR81	0.60 0.40 (Note 2)	70°C 110°C
Tantalum, Solid (Note 3)	CSR, CSS, CWR	0.50 0.30 (Note 2)	70°C 110°C

Notes:

1. For low-voltage applications (<10 Vdc), rated voltage shall be at least 100 Vdc for Styles CCR, CKR, CDR.
2. Derate voltage linearly from 70°C to 110°C.
3. The effective series resistance shall be at least 0.1 ohms per volt or 1 ohm, whichever is greater, for Grade 2 applications, and at least 0.3 ohms per volt for Grade 1 applications.

Table 02 Connector Derating Criteria

Type/Style	Voltage Derating Factor (Note 1)	Maximum Ambient Temperature
All	0.25	Rated temperature minus 25°C

Notes:

1. Voltage derating factor is given as a percentage of the sea level Dielectric Withstanding Voltage.

Table 03 Filter Derating Criteria

Class	Stress Parameter (Note 1)	Derating Factor
All	Rated current	0.50
	Rated voltage	0.50
	Maximum Ambient Temperature	85°C or 30°C less than maximum rated temperature, whichever is less

Notes:

1. Applies to rated operating current or voltage, not the absolute maximum.

Table 04 Fuse Derating Criteria (Notes 1-4)

Fuse Current Rating (Amperes)	Derate to the Following (%) of Rated Current	Remarks
15, 10, 7, 5, 4, 3, 2, 2-1/2, 2	50%	
1-1/2, 1	45%	
3/4	40%	
1/2	40%	
3/8	35%	
1/4	30%	The flight use of fuses rated 1/2 ampere or less requires application approval by the cognizant GSFC project office.
1/8	25%	

Notes:

1. Fuses are specified to interrupt within a maximum of five seconds when driven at 200% of their rated current for nominal ratings up to and including 10 amperes. A fuse with a nominal rating of 15 amperes is specified to interrupt within a maximum of ten seconds when driven at 200% of its rated current.
2. Derating of fuses allows for possible loss of internal gases in a space environment which reduces heat transfer by conduction. This lowers the blow current rating and decreases current capability with time.
3. Additional derating of the lower current rated fuses allows for the smaller geometries which reduce heat transfer by conduction.
4. Derating factors are based on data from fuses mounted on printed circuit boards and conformally coated. Other type mountings require GSFC project office approval.

Table 05 Coil/Inductor Derating Criteria (Note 1)

Type Class Insulation	Stress Parameter	Minimum Derating
MIL-C-39010/15305	Rated operating temperature	
O	85°C	65°C
A	105°C	85°C
B	125°C	105°C
F	150°C	130°C
All	Rated operating voltage	50% of rated dielectric withstanding voltage

Notes:

1. a. Maximum operating temperature equals ambient temperature plus temperature rise plus 10°C allowance for hot spots. The temperature rise may be calculated in accordance with MIL-T-27, paragraph 4.8.12.
- b. The insulation classes of MIL- style inductive parts generally have operating temperature ratings based on a life expectancy of 10,000 hours. The derated operating temperatures are selected to extend the life expectancy to 50,000 hours at rated voltage.
- c. Custom made inductive devices shall be evaluated on a materials basis to determine the maximum operating temperature. Devices with temperature ratings different from the military insulation classes shall be derated to 0.75 times maximum operating temperature.

Table 06 Relay Derating Criteria (Note 1)

Style	Make, Break, and/or Carry Load Currents	Transient Current Surges (Note 3)																																				
All	Select the appropriate factors for T, R, and L from the subtables: $I_{\text{derated}} = I_{\text{rated}} \times T \times R \times L$ (Note 2)	For $t \leq 10\mu\text{s}$, $I_{\text{max}} \leq 4 \times I_{\text{rated}}$ For $t > 10 \mu\text{s}$, $(I_{\text{max}})^2 \times t \leq 16 \times (I_{\text{rated}})^2 \times 10^{-5} \text{ (A}^2\text{s)}$																																				
<table border="1"> <thead> <tr> <th align="center" colspan="2">Subtable T</th> <th align="center" colspan="2">Subtable R</th> <th align="center" colspan="2">Subtable L</th> </tr> <tr> <th align="center">Temperature Range</th> <th align="center">Factor</th> <th align="center">Cycle Rate per Hour</th> <th align="center">Factor</th> <th align="center">Load Application</th> <th align="center">Factor</th> </tr> </thead> <tbody> <tr> <td align="center">+85°C to +125°C</td> <td align="center">0.7</td> <td align="center">>10</td> <td align="center">0.85</td> <td align="center">Make, break and/or carry loads with an on-time duration of 0 to 500 ms. Off-time is equal to or greater than on-time.</td> <td align="center">1</td> </tr> <tr> <td align="center">+40°C to +84°C</td> <td align="center">0.85</td> <td align="center">1 to 10</td> <td align="center">0.90</td> <td align="center">Carry-only loads. Relay does not make or break the load. Maximum on-time is 5 minutes. Off-time is equal to or greater than on-time.</td> <td align="center">1.5</td> </tr> <tr> <td align="center">-20°C to +39°C</td> <td align="center">0.9</td> <td align="center"><1</td> <td align="center">0.85</td> <td align="center">All other load conditions.</td> <td align="center">0.8</td> </tr> <tr> <td align="center">-65°C to -21°C</td> <td align="center">0.85</td> <td></td> <td></td> <td></td> <td></td> </tr> </tbody> </table>			Subtable T		Subtable R		Subtable L		Temperature Range	Factor	Cycle Rate per Hour	Factor	Load Application	Factor	+85°C to +125°C	0.7	>10	0.85	Make, break and/or carry loads with an on-time duration of 0 to 500 ms. Off-time is equal to or greater than on-time.	1	+40°C to +84°C	0.85	1 to 10	0.90	Carry-only loads. Relay does not make or break the load. Maximum on-time is 5 minutes. Off-time is equal to or greater than on-time.	1.5	-20°C to +39°C	0.9	<1	0.85	All other load conditions.	0.8	-65°C to -21°C	0.85				
Subtable T		Subtable R		Subtable L																																		
Temperature Range	Factor	Cycle Rate per Hour	Factor	Load Application	Factor																																	
+85°C to +125°C	0.7	>10	0.85	Make, break and/or carry loads with an on-time duration of 0 to 500 ms. Off-time is equal to or greater than on-time.	1																																	
+40°C to +84°C	0.85	1 to 10	0.90	Carry-only loads. Relay does not make or break the load. Maximum on-time is 5 minutes. Off-time is equal to or greater than on-time.	1.5																																	
-20°C to +39°C	0.9	<1	0.85	All other load conditions.	0.8																																	
-65°C to -21°C	0.85																																					

Notes:

1. **WARNING:** Do not derate coil voltage or current. Operating a relay at less than nominal coil rating can result in either switching failures or increased switching times. The latter condition induces contact damage because of the longer arcing time, thus reducing relay reliability.
2. I_{derated} = derated contact current carrying capacity
 I_{rated} = rated contact current
3. If during switching, transient current surges exceed the derated contact current, the following applies, where:
 t = period of time that transient current exceeds rated contact current (I_{rated})
 I_{max} = maximum permitted surge current
 I_{rated} = rated contact current

Table 07 Resistor Derating Criteria

Style	Description	Derating Factors		Derating Temperatures (°C)		Zero Power Temp. (°C)
		(Note 1)	(Note 2)	T1	T2	T3
G311P672	Fixed, High Voltage	0.6	0.8	70	94	110
G311P683	Fixed, Precision, High Voltage	0.6	0.8	125	185	225
G311P742	Fixed, Low TC, Precision	0.6	0.8	125	155	175
RBR	Fixed, Wirewound (Accurate), ER	0.6	0.8	125	137	145
1%		0.35	0.8	125	132	145
0.5%		0.25	0.8	125	130	145
0.1%						
RWR	Fixed, Wirewound (Power Type), ER	0.6	0.8	25	160	250
RCR	Fixed, Composition (Insulated), ER	0.6	0.8	70	(Note 3)	(Note 3)
RER	Fixed, Wirewound (Power Type), Chassis Mounted, ER	0.6	0.8	25	160	250
RTR	Variable, Wirewound (Lead Screw Actuated), ER	0.6	0.8	85	124	150
RLR	Fixed, Film (Insulated), ER	0.6	0.8	70	118	150
100ppm		0.6	0.8	70	103	125
350ppm						
RNX	Fixed, Film, ER	0.6	0.8	125	155	175
RM	Fixed, Film, Chip, ER	0.6	0.8	70	118	150
RZ	Fixed, Film, Networks	0.6	0.8	70	103	125
Others	Various	0.5	0.8	(Note 4)	(Note 4)	(Note 4)

Notes:

1. Compute the resistor's derated power level by multiplying its nominal power rating by the appropriate derating factor for ambient temperatures $\leq T1$. If the resistor is operated above $T1$, derate linearly from the $T1$ power level to the zero power level at $T2$. Exposing the resistor to temperatures exceeding $T3$, even under no load conditions, may result in permanent degradation.
2. The maximum applied voltage shall not exceed the lesser of the following: (1) 80% of the specified maximum voltage rating, or (2) \sqrt{PR}
 where
 P = Derated power (Watts)
 R = Resistance of that portion of the element actually active in the circuit.
 This voltage derating applies to dc and regular ac waveform applications. For pulse and other irregular waveform applications, consult MIL-HDBK-978 or the manufacturer.
3. Determine the zero power temperature ($T3$) from the applicable detail specification. Compute the derated zero power temperature ($T2$) from the following formula:

$$T2 = D_F(T3 - T1) + T1$$
 where:
 $T2$ = Derated zero power temperature
 D_F = Derating factor
 $T3$ = Zero power temperature
 $T1$ = Rated power temperature
4. Determine the rated power, the rated power temperature ($T1$), and the zero power temperature ($T3$) from the manufacturer's specification. Calculate the derated zero power temperature ($T2$) as per the previous note.

Table 08 Diode Derating Criteria

Diode Type	Stress Parameter	Derating Factor
General purpose, Rectifier, Switching, Pin/Schottky, and Thyristors	PIV	0.70
	Surge current	0.50
	Forward current	0.50
	Maximum Junction Temperature	0.80
Varactor	Power	0.50
	Reverse voltage	0.75
	Forward current	0.75
	Maximum Junction Temperature	0.80
Voltage Regulator	Power	0.50
	Zener current	$0.5(I_{z,max} + I_{z,nom})$
	Maximum Junction Temperature	0.80
Voltage reference	Zener current	N/A
	Maximum Junction Temperature	0.80
Zener Voltage Suppressor	Power dissipation	0.50
	Maximum Junction Temperature	0.80
Bidirectional Voltage Suppressor	Power dissipation	0.50
	Maximum Junction Temperature	0.80
FET Current Regulator	Peak operating voltage	0.80
	Maximum Junction Temperature	0.80

Table 09 Transistor Derating Criteria

Type	Stress Parameter	Derating Factor
All (Note 2)	Power	0.60
	Current	0.75
	Voltage (Note 1)	0.75
	Junction Temperature	0.80

Notes:

1. Worst-case combination of DC, AC, and transient voltage should be no greater than the derated limit.
2. For power MOSFET devices, also derate the gate to source voltage (V_{GS}) to 60% of the maximum rated value.

Table 10 Microcircuit Derating Criteria (Note 1)

Stress Parameter	Derating Factor	
	Digital	Linear
Maximum Supply Voltage/Input Voltage (Note 1)	0.9	0.9
Power Dissipation	0.8	0.75
Maximum Specified Operating Junction Temperature (Note 2)	0.8	0.75
Maximum Output Current	0.8	0.8

Notes:

1. Use manufacturer's recommended operating conditions but do not exceed 90% of maximum supply voltage. For voltage regulators, derate $V_{IN} - V_{OUT}$ to 0.9.
2. Do not exceed $T_j = 100^\circ\text{C}$ for silicon digital microcircuits or $T_j = 93.5^\circ\text{C}$ for silicon linear microcircuits.

Table 14 Thermistor Derating Criteria (Note 1)

Type	Derating
Positive Temperature Coefficient	Derate to 50% of rated power.
Negative Temperature Coefficient	Derate to a power level causing a maximum increase of 50 times the dissipation constant, or a maximum case temperature of 100°C , whichever is less.

Notes:

1. Derating is applicable to thermistors operating in the self-heating mode.

Table 15 Transformer Derating Criteria (Note 1)

Type Class Insulation	Stress Parameter	Minimum Derating
MIL-T-27	Rated operating temperature	
Q	85°C	65°C
R	105°C	85°C
S	130°C	110°C
All	Rated operating voltage	50% of rated dielectric withstanding voltage

Notes:

1. a. Maximum operating temperature equals ambient temperature plus temperature rise plus 10°C allowance for hot spots. The temperature rise may be calculated in accordance with MIL-T-27, paragraph 4.8.12.
b. The insulation classes of MIL- style inductive parts generally have operating temperature ratings based on a life expectancy of 10,000 hours. The derated operating temperatures are selected to extend the life expectancy to 50,000 hours at rated voltage.
c. Custom made inductive devices shall be evaluated on a materials basis to determine the maximum operating temperature. Devices with temperature ratings different from the military insulation classes shall be derated to 0.75 times maximum operating temperature.

Table 16 Wire and Cable Derating Criteria (Note 1, 2, 3)

Wire Size (AWG)	Derated Current (Amperes)	
	Single Wire	Bundled Wire or Cable
30	1.3	0.7
28	1.8	1.0
26	2.5	1.4
24	3.3	2.0
22	4.5	2.5
20	6.5	3.7
18	9.2	5.0
16	13.0	6.5
14	19.0	8.5
12	25.0	11.5
10	33.0	16.5
8	44.0	23.0
6	60.0	30.0
4	81.0	40.0
2	108.0	50.0
0	147.0	75.0
00	169.0	87.5

Notes:

1. Derated current ratings are based on an ambient temperature of 70°C or less in a hard vacuum of 10⁻⁶ torr.
2. The derated current ratings are for 200°C rated wire, such as Teflon™ insulated (Type PTFE) wire, in a hard vacuum of 10⁻⁶ torr.
 - a. For 150°C wire, use 80% of value shown in Table 16.
 - b. For 135°C wire, use 70% of value shown in Table 16.
 - c. For 105°C wire, use 50% of value shown in Table 16.
3. The current rating for bundles or cables are based on bundles of 15 or more wires. For smaller bundles, the allowable current shall be determined by $I_{BW} = I_{SW} \times (29-N)/28$ where N = number of wires, I_{BW} = current, bundled wire and I_{SW} = current, single wire.

THIS PAGE INTENTIONALLY LEFT BLANK

Table 01 Capacitor Screening Requirements (Page 1 of 3)

Inspection/Test	Test Methods, Conditions and Requirement (Note 1)	Part Type/Grade Level															
		Ceramic		Plastic		Tantalum		Glass		Mica		Variable		RFI Feed-Thru		Switch Mode Power Supply	
		1	2	1	2	1	2	1	2	1	2	1	2	1	2	1	2
1. a. Visual and mechanical Examination. b. Electrical Measurements	Optional for all grades. Same as step 10 and step 5.																
2. Thermal Shock	MIL-STD-202, Method 107, Condition B, -55°C to +125°C	X	X	X	X	X	X	X	X	X	X	X	X	X	X	X	X
3. Voltage Conditioning (Burn-In)	2 x Rated Voltage, 125°C, 160 hours	X	X							X	X					X	X
	140% rated voltage, 125°C, 48 hours			X	X												
	1.2 x rated AC voltage at maximum rated frequency, 160 hours												X	X			
	Rated voltage 85°C, 48 hours					X	X										
	3 x rated voltage room temp., 48 hours							X	X								
4. Surge Current	MIL-C-39003/10					X											
5. High Impedance temp. and voltage ramp (Note 2)	5 cycles, -55°C to 100°C in accordance with MIL-C-872147 4.7.4			X													

See notes on page C-3.

Table 01 Capacitor Screening Requirements (Page 2 of 3)

Inspection/Test	Test Methods, Conditions and Requirement (Note 1)	Part Type/Grade Level															
		Ceramic		Plastic		Tantalum		Glass		Mica		Variable		RFI Feed-Thru		Switch Mode Power Supply	
		1	2	1	2	1	2	1	2	1	2	1	2	1	2	1	2
6. Electrical measurements	As specified. (Note 3)																
Capacitance	MIL-STD-202, Method 305	X	X	X	X	X	X	X	X	X	X	X	X	X	X	X	X
Dissipation Factor		X	X	X	X	X	X	X	X	X	X	X	X	X	X	X	X
DWV	MIL-STD-202, Method 301	X	X	X	X	X	X	X	X	X	X	X	X	X	X	X	X
Insulation Resistance 1	MIL-STD-202, Method 302	X	X	X	X			X	X	X	X	X	X	X	X	X	X
Insulation Resistance 2	Repeat at 125°C	X		X		X		X		X		X		X		X	
DC Leakage 1	MIL-STD-202, Method 301					X	X										
DC Leakage 2	Repeat at 85°C					X											
Equivalent Series Resistance Quality Factor Driving Torque Insertion Loss						X	X					X	X			X	X
7. Percent Defective Allowable	5% for Grade 1 10% for Grade 2	X	X	X	X	X	X	X	X	X	X	X	X	X	X	X	X
8. Partial Discharge (Note 4)	MIL-C-49467 Appendix B	X	X														
9. Seal Test (Hermetic Types Only)	MIL-STD-202, Method 112																
Gross Leak	Condition A or B			X	X	X	X							X	X		
Fine Leak	Condition C			X		X								X			
10. Radiographic Inspection	MSFC-STD-355C	X		X		X				X		X		X		X	
11. Visual and Mechanical Examination	Dimensions, Marking, Workmanship	X	X	X	X	X	X	X	X	X	X	X	X	X	X	X	X
12. Humidity Steady State, Low Voltage (Note 5)	MIL-STD-202, Method 103, Condition A and MIL-C-123, Paragraph 4.6.16.1	5(0)	5(0)													5(0)	5(0)

See notes on page C-3.

Table 01 Capacitor Screening Requirements (Page 3 of 3)

Notes:

1. User should refer to the nearest equivalent military specification listed in Table 01A if required for better definition of testing requirements.
2. Required only for metallized polycarbonate low energy, high impedance capacitors similar to those specified by MIL-C-87217.
3. It is the responsibility of the user to define minimum and maximum values for each parameter (pass/fail criteria) and delta criteria, if applicable. These values should be based on the nearest equivalent military specification, manufacturer specifications, or the application, whichever is most stringent.
4. Required only for high voltage capacitors similar to those specified by MIL-C-49467. This test requirement may affect capacitor design and should be performed by the manufacturer. If performed only by the user, it could result in a high probability of failure.
5. Required only for capacitors with applied voltage of 10 volts or less. Five parts shall be tested with zero failures allowed.

Table 01A Equivalent Military Specifications

<p align="center"><u>Ceramic</u></p> <p>MIL-C-123 MIL-C-39014 MIL-C-49467 Multilayer, High Voltage MIL-C-55681 Chip, Multiple Layer MIL-C-49464 Chip, Parallel Plate</p>	<p align="center"><u>Glass</u></p> <p>MIL-C-23269</p>
<p align="center"><u>Plastic (Paper Plastic)</u></p> <p>MIL-C-55514 Nonmetal MIL-C-83421 Metallized, Hermetic MIL-C-87217 Supermetallized, Low Energy High Impedance</p>	<p align="center"><u>Mica</u></p> <p>MIL-C-39001 MIL-C-87164</p> <p align="center"><u>Filter</u></p> <p>MIL-C-83439 EMI Suppression MIL-F-28861</p>
<p align="center"><u>Tantalum</u></p> <p>MIL-C-39003 Solid Electrolyte MIL-C-39006 Nonsolid Electrolyte MIL-C-83500 Nonsolid Electrolyte MIL-C-55365 Chip</p>	<p align="center"><u>Variable</u></p> <p>MIL-C-14409 Piston, Tubular Trimmer</p> <p align="center"><u>Switch Mode Power Supply</u></p> <p>DESC 87106</p>

Table 02 Connector Screening Requirements (Notes 1, 2) (Page 1 of 7)

Inspection/ Test	Test Methods, Conditions and Requirements	Connector Type/Grade Level							
		Circular		D-Subminiature		Microminiature		Printed Circuit	
		1	2	1	2	1	2	1	2
Visual Inspection	Verify proper marking, free of workmanship defects in accordance with Table 02A. 3X magnification (min.) and high intensity lighting.	X	X	X	X	X	X	X	X
Mechanical Inspection	Verify design, construction, dimensions, materials and finish.	X	2 (0)	X	2 (0)	X	2 (0)	X	2 (0)
Dielectric Withstanding Voltage (Sea Level)	MIL-STD-1344, Method 3001. Refer to reference specifications for voltages, mating requirements.	X	2 (0)	X	2 (0)	X (Note 3)	X (Note 3)	X	2 (0)
Insulation Resistance	MIL-STD-1344, Method 3003, Condition B. 5000 megohms min. in accordance with reference specifications.	X	2 (0)	X	2 (0)	X	2 (0)	X	2 (0)
Outgassing Control (As req'd)	(Note 4)	X	X	X	X	X	X		
Contact engagement and separation force. (non-removable socket contacts)	MIL-STD-1344, Method 2014, MIL-C-83513, Paragraph 4.7.8 for microminiature connectors. (Note 5)	2 (0)	2 (0)	2 (0)	2 (0)	2 (0)	2 (0)	2 (0)	2 (0)
Thermal shock (liquid to liquid, hermetic receptacles only)	MIL-C-38999, paragraph 4.7.3. Ten cycles from 4°C max to 90°C min. Transfer time shall not exceed 5 seconds. Dwell time shall be 10 minutes, min at each extreme.	X	2 (0)						
Hermeticity (Sealed Receptacles Only)	MIL-STD-1344, Method 1008, Pressure differential across the connector shall be 1 atmosphere (14.7 PSI). Leakage shall not exceed 1×10^{-7} ATM CM ³ /Sec or as otherwise specified.	X	2 (0)	X	2 (0)				

See notes on page C-9.

Table 02 Connector Screening Requirements (Notes 1, 2) (Page 2 of 7)

Inspection/ Test	Test Methods, Conditions and Requirements	Connector Type/Grade Level							
		Circular		D-Subminiature		Microminiature		Printed Circuit	
		1	2	1	2	1	2	1	2
Contact Retention	MIL-STD-1344, Method 2007. Apply load per reference specification.	2 (0)	2 (0)	2 (0)	2 (0)	2 (0) (Note 6)	2 (0) (Note 6)	2 (0)	2 (0)
Residual Magnetism (Non magnetic Connectors and Contacts)	S-311-P-4, Paragraph 4.5.1 or S-311-P-10, Paragraph 4.5.5			X (Note 7)	X (Note 7)				
Mating and Unmating Force	MIL-STD-1314, Method 2013 MIL-C-55302, Paragraph 4.7.4. Force shall be per reference specification x no. of contacts.			2 (0)	2 (0)	2 (0)	2 (0)	2 (0)	2 (0)
Low Level Signal Contact Resistance (Note 8)	MIL-STD-1344 Method 3002					X	2 (0)	X	2 (0)
Resistance to Soldering Heat (Note 9)	MIL-C-24308, Paragraph 4.7.2.6 MIL-C-83513, Paragraph 4.7.11 MIL-STD-202, Method 210, Condition C			2 (0)	2 (0)	2 (0)	2 (0)	2 (0)	2 (0)

See notes on page C-9.

Table 02 Connector Screening Requirements (Notes 1, 2) (Page 3 of 7)

Inspection/ Test	Test Methods, Conditions and Requirements	Connector Type/Grade Level							
		Radio Frequency		Contacts		EMI Filter Pin		High Voltage	
		1	2	1	2	1	2	1	2
Visual Inspection	Verify proper marking, free of workmanship defects in accordance with Table 02A. 3X magnification (min.) and high intensity lighting.	X	X	X	X	X	X	X	X
Mechanical Inspection	Verify design, construction, dimensions, materials and finish.	X	2 (0)	X	2 (0)	X	1(0)	X	2 (0)
Dielectric Withstanding Voltage (Sea Level)	MIL-STD-1344, Method 3001. MIL-STD-202, Method 301 for RF connectors. Refer to reference specifications for voltages, mating requirements.	2 (0) (Note 10)		2 (0) (Note 11)	X (Note 11)	X (Note 12)	X (Note 12)	X (Note 13)	X (Note 13)
Insulation Resistance	MIL-STD-202, Method 302 for RF connectors and filter pins. 5000 megohms min. in accordance with reference specifications.	2 (0)				X	X		
Outgassing Control (As required)	(Note 4)	X	X	X	X	X	X	X	X
Contact engagement and separation force.	MIL-STD-1344, Method 2014.			X (Note 14)	X (Note 14)				
Hermeticity (Sealed Receptacles Only)	MIL-STD-202, Method 112, Condition C, Procedure III. Pressure as specified.	X	2 (0)						
Contact Retention	MIL-C-39012, Paragraph 4.6.9. Apply load per reference specification.	2 (0)	2 (0)						

See notes on page C-9.

Table 02 Connector Screening Requirements (Notes 1, 2) (Page 4 of 7)

Inspection/ Test	Test Methods, Conditions and Requirements	Connector Type/Grade Level							
		Radio Frequency		Contacts		EMI Filter Pin		High Voltage	
		1	2	1	2	1	2	1	2
Residual Magnetism (Non magnetic Connectors and Contacts)	S-311-P-4, Paragraph 4.5.1 and S-311P-4/08 or /10, Paragraph 3.1.1.			X (Note 7)	X (Note 7)				
Engage/Disengage Force	MIL-C-39012, Paragraph 4.6.2. 2 inch-lbs torque min. for SMA types.	2 (0)	2 (0)						
Coupling Proof Torque (Plugs Only)	MIL-C-39012, Paragraph 4.6.3. 15 inch-lbs torque min. for SMA types.	2 (0)	2 (0)						
Voltage Conditioning	MIL-STD-202 Method 108. 125°C. 2 x rated dc voltage. 168 hours min. per GSFC S-311-P-626.					X	X		
Capacitance	MIL-STD-202, Method 305, and S-311-P-626					X	X		
Attenuation	MIL-STD-220 and S-311-P-626 paragraph 4.8.9.1.					X	X		

See notes on page C-9.

Table 02 Connector Screening Requirements (Page 5 of 7)

Notes:

1. For commercial connectors procured from a manufacturer who is listed on the QPL for a similar connector, screening tests do not have to be repeated if attributes data or a certificate of compliance is acquired from the manufacturer, and indicate that the tests were performed. However, sample testing can never be a substitute for 100% testing. 100% examination may be performed at the user's receiving and inspection facilities in lieu of performance by the manufacturer.
2. An "X" in the table indicates that the inspection/test is to be performed on a 100% basis. Y (0) indicates the quantity (accept number) for sample testing. If a failure occurs during sample testing, the tests shall either be performed on a 100% basis or the sample size shall be tripled and the tests repeated. If a failure occurs during the second sample test, the lot shall be rejected.
3. For MIL-C-83513 microminiature connectors with crimp type pig tail leads, adjacent leads shall be tested for shorting prior to DWV. Each lead shall be tested. For DWV testing, a test potential of 600 VRMS (sea level) shall be used. If manufacturer can certify that this test is performed on each connector, additional testing is not required.
4. All non metallic materials shall be traceable to acceptable outgassing test results in NASA reference publication 1124 or MSFC-HDBK-527.
 - a. Some QPL manufacturers provide circular connectors which are specially processed to meet outgassing requirements, indicated by a special suffix to the commercial equivalent of the military part number. The user may process connectors for outgassing control by removing and replacing lubricant with a low outgassing lubricant followed by a bakeout of 24 hours at 125°C. Low outgassing lubricants as well as other acceptable variations of bakeout time, temperature, and vacuum for outgassing control are contained in NASA Reference publication 1124. Since removal and replacement of lubricant requires disassembly and is labor intensive, it is recommended that this processing be performed by the manufacturer to a controlled specification.
 - b. Some commercial D-Subminiature connectors contain a rear silicone rubber sealing grommet behind the connector which provides wire support and seals the rear of the connector, but represents an outgassing concern. A bakeout of 125°C for 24 hours is recommended for outgassing control.
 - c. Microminiature receptacles contain either a fluorosilicone (acceptable) or silicone rubber interface seal. The silicone rubber seal may be an outgassing concern and can be carefully removed with small tweezers and discarded. Otherwise, a bakeout of 24 hours at 125°C is recommended.
 - d. Type SMA RF connector plugs may contain a silicone rubber O-Ring interface seal inside the coupling nut, on the mounting flange or inside the cable nut, and require replacement with fluorosilicone O-Rings or a 125°C bakeout for 24 hours to prevent outgassing.
 - e. High voltage panel mount receptacle connectors contain a small silicone rubber grommet which surrounds the center pin contact. This grommet is an outgassing concern, and a bakeout of 125°C is recommended for outgassing control.

Table 02 Connector Screening Requirements (Page 6 of 7)

Notes (Continued):

5. a. Circular connectors. Applies to nonremovable solder socket contacts only. In-process inspections shall be used. MS3197 test pin shall be inserted to .7L and measured forces shall comply with MIL-C-39029, Table IX. All socket contacts shall be measured for acceptable levels of separation force. Ten percent of contacts selected at random shall be measured for insertion force.
- b. D-Subminiature connectors. Applies to nonremovable solder socket contacts. Insert and remove maximum diameter MS3197 gage pin. Insert minimum diameter gage pin, and measure separation force. Insert and separate maximum diameter gage pin three times, and measure engagement force during third cycle. All measurements shall comply with MIL-C-39029, Table IX. Test 20 percent of contacts (min of four) from each sample.
- c. Microminiature connectors. Twenty percent of pin contacts (min of seven) per test sample shall be tested using socket test sleeves per MIL-C-83513. Engagement force shall be 6 ounces maximum per contact. Separation force shall be 0.5 ounces minimum per contact.
- d. Printed Circuit Connectors. In process testing shall be used. Applies to socket contacts only. Insert MS3197 test pins to a depth of .140 inches. Maximum engagement force shall be 12 ounces per contact for standard force contacts and 4 ounces per contact for low insertion force contacts. Minimum separation force is 5 ounces per contact (each type). Sample size shall be per MIL-STD-105, general inspection level II, .65% AQL.
6. For MIL-C-83513 microminiature connectors with crimp type pigtail leads, apply a 5 lb. load to individual wire pigtails for 6 seconds, minimum. Load shall not displace contact or pull the wire from the crimp contact.
7. When low residual magnetism is a requirement, each connector must be tested for specific levels of residual magnetism. The test procedure in GSFC S-311-P-4, Paragraph 4.5.1 or S-311-P-10, Paragraph 4.5.5 shall apply. The test procedure in GSFC S-311-P-4/08 and /10 paragraph 3.3.1 shall apply for contacts. Contacts shall be grouped together and the measured value for the group shall not exceed a gamma level of 0.1 x the number of contacts in the group. Following testing, connectors and contacts shall be demagnetized per S-311-P-4 paragraph 6.1.3 or equivalent. Performance of residual magnetism requires the use of specialized test equipment and should be performed at the manufacturer's facilities.
8. Test is intended to determine resistance of contacts with crimp joined or weld joined solid straight or formed wire leads. Test shall be performed using a micro-ohmmeter and four wire measurements. Mated connector pairs are preferred. Attached current leads at extreme ends of contacts. Attach voltage leads at contact lead closest point to engagement barrel without touching barrel. Apply one milliamp DC or as otherwise specified. Measurement shall not exceed 15 milliohms for size 22 contacts, 20 milliohms for size 24 contacts, 32 milliohms for size 26 contacts, or as otherwise specified.
9. Test is not required for connectors with diallyl phthalate insert material. For connectors with thermoplastic insert material, test 20% of contacts (7 minimum). Solder cup contacts or PC terminations shall be soldered with a pencil type iron heated to 360°C using SN63 solder for a minimum duration of four seconds. There shall be no evidence of damage or distortion. Contact floating conditions, if applicable, shall be maintained.
10. For coaxial connectors, the connector shall be terminated to the appropriate coaxial cable, and the applied voltage shall be as specified in the detail specification.
11. For coaxial contacts, the dielectric withstanding voltage test shall be performed in accordance with MIL-STD-1344, Method 3001. A voltage of 1000 VRMS (Sea Level) shall be applied for 10 seconds between inner contact and shell.

Table 02 Connector Screening Requirements (Page 7 of 7)

Notes (Continued):

12. For filter pin connectors, dielectric withstanding voltage of twice the rated dc voltage shall be applied for five to ten seconds between each contact and the shell. Current shall be limited to 20 milliamps.
13. High voltage connectors have voltage ratings in excess of 5KV and are similar to Reynolds part numbers 167-3770 and 167-3771. For high voltage connectors rated at 10KVDC, a potential of 15KVDC shall be applied to each connector for 10 seconds, minimum.
14. Applies to sockets only. For both contact engagement force and contact separation force, engage contact with MS3197 test pin to a depth of 0.7L. Force shall comply with MIL-C-39029, Table IX. For sizes 16 and smaller, each contact shall be tested for separation force. MIL-STD-105, general inspection level II, 1% AQL shall apply for larger contact sizes and for insertion force.

Table 02A Inspection Criteria for Connectors and Contacts (Note 1)

DEFECT	Circulars	DSUBS	Micro-miniature	PC	RF	Contacts	RF Contacts	Filter Pin	High Voltage
INSERT	X	X	X	X	X		X	X	X
Insert to Shell Positioning and Orientation	X	X	X	X	X		X	X	X
Cracks, Chips	X	X	X	X	X		X	X	X
Marking				X				X	
Negative Meniscus of Glass (Hermetics only-glass to contact and glass to shell)	X	X			X				
GROMMET	X								X
Nicks, Gouges, Tears, Folds	X								X
Marking	X		X						
SHELLS	X	X	X		X	X	X	X	X
Cracks, Dents, Scratches	X	X	X		X	X	X	X	X
Finish (Peeled or blistered plating, discoloration, exposed base metal)	X	X	X		X	X	X	X	X
Marking Completeness, Legibility	X	X	X		X	X	X	X	
Sleeves (Fixed - Not free to move)						X	X		
THREADS (As Applicable)	X				X				X
Nicks, Dents, Voids	X				X				X
ADHESIVES	X	X	X	X	X			X	X
Excess Bonding Material (Overflow)	X	X	X	X	X			X	X
Voids	X	X	X	X	X			X	X

Table 03 Filter Screening Requirements

Inspection/Test	Test Methods Conditions, and	Grade 1	Grade 2
	Requirements Reference MIL-F-28861		
1) Visual Inspection	Elements and subassemblies in accordance with paragraph 4.6.1.2	X	X
2) External Visual	Dimensions, marking, workmanship	X	X
3) Thermal Shock	MIL-STD- 202, Method 107 Condition A except step 3 shall be 125°C	X (Note 1)	X
4) Voltage Conditioning (Burn-In) Duration (Hours)	MIL-STD-202, Method 108, 125°±3°C. 2 x rated voltage for dc rated. 1.2 x rated ac voltage at max. rated frequency for ac, ac/dc rated	X (Note 2) 240	X 160
5) Insulation Resistance or DC Leakage Current	MIL-STD-202, Method 302, rated dc voltage applied for 2 minutes max., charging current of 50 mA max.	X (Note 3)	X (Note 3)
6) Capacitance to ground	MIL-STD-202, Method 305, 1.0±.2V RMS. 1 Mhz ±100khz for capacitors ≤100pF. 1khz ±100Hz for Capacitors ≥100pF	X	X
7) Dissipation factor	Frequency and voltage specified in 6) above. Accuracy shall be ± 2 percent.	X	X
8) Insertion Loss	MIL-STD-220 and paragraph 4.6.5	X	X
9) Voltage Drop	ac and dc. Paragraph 4.6.6	X	X
10) Radiographic Inspection	MIL-STD-202, Method 209 and paragraph 4.6.8	X	
11) Seal Test (Hermetic types only) Gross Leak Fine Leak	MIL-STD-202, Method 112 Condition A or B Condition C	X X	X

Notes:

- Grade 1 filters shall be torqued in place and insulation resistance measured at 125°C before removing filter from plate.
- Polarity shall be reversed from first 24 to 72 hours. Refer to paragraph 4.6.2.2.2 and Figure 1 for test circuit.
- Shall be measured within 1 hour after voltage conditioning.

Table 04 Fuse Screening Requirements

Inspection/Test	Test Methods, Conditions, and Requirements (Note 1)	Notes	Part Type/Grade Level	
			1	2
Visual Inspections	Materials, design, construction, marking, and workmanship		X	X
Mechanical Inspections	Body and lead dimensions to specification	2	X	X
Resistance (Cold)	MIL-STD-202, Method 303 Resistance to specification	3	X	X
Voltage Drop (Hot-1)	100% rated current for 5 minutes (minimum) Voltage drop to specification (when specified)	4	X	X
Thermal Shock	MIL-STD-202, Method 107 Condition B	5, 6	X	X
Voltage Drop (Hot-2)	100% rated current for 5 minutes (minimum) Ratio voltage drop: (Hot-1/Hot-2) = 0.97 to 1.03		X	X
Resistance (Cold)	MIL-STD-202, Method 303 Resistance to specification	3	X	X
Seal	MIL-STD-202, Method 112 Test Condition A		X	X
Percent Defective Allowable (PDA)	Grade 1- 5% Grade 2- 10%	7	X	X

Notes:

1. It is the responsibility of the user to specify the test conditions and define the pass/fail criteria for each inspection. These values shall be based on the nearest equivalent military specification, the manufacturer's specification, or the application, whichever is most severe.
2. A minimum of three fuses shall be measured. In the event of failure, the entire lot shall be screened for dimensions and rejects discarded.
3. The source current for the resistance measurement shall not exceed 10% of the nominal current rating at room temperature.
4. The voltage drop (hot) measurement must be recorded to calculate the voltage drop ratio regardless of whether or not it is a specification requirement.
5. Fuses rated < +125°C shall be tested to Condition A.
6. External visual examination is required after testing to verify no evidence of mechanical damage.
7. Marking and voltage ratio rejects shall not be counted for purposes of establishing the defect rate.

Table 05 Coil/Inductor Screening Requirements

Testing	Test Methods and Conditions (Note 1)	Part Type (Note 2)					
		Group 1 Grade		Group 2 Grade		Group 3 Grade	
		1	2	1	2	1	2
Thermal Shock 25 Cycles 10 Cycles	MIL-STD-202, Method 107 Continually monitor during final cycle to verify no intermittent conditions in accordance with MIL-STD-981 (Note 3)	X	X	X	X	X	X
No Load Burn-In	96 hrs. at max. rated temperature. No voltage applied.	X	X	X	X	X	X
Seal (if applicable)	MIL-T-27 Paragraph 4.8.7	X	X				
D W V	MIL-STD-202, Methods 301 and 105 (Note 4)	X	X	X	X	X	X
Q				X	X	X	X
Self Resonant Frequency				X	X	X	X
Insulation Resistance	MIL-STD-202 Method 302, 500V dc or as Specified	X	X	X	X	X	X
Inductance		X	X	X	X	X	X
DC Resistance		X	X	X	X	X	X
Radiographic	MIL-STD-981 Appendix C	X		X		X	
Visual		X	X	X	X	X	X

Notes:

1. Test methods not specified herein shall be in accordance with MIL-T-27, MIL-C-15305, and MIL-C-83446 for Group 1, 2, and 3 inductors respectively.
2. Group 1 includes power, audio, charging, and saturable inductors (families 04, 20, 37 and 41 respectively). Group 2 includes radio frequency, fixed and variable coils (families 13 and 14 respectively). Group 3 includes radio frequency, chip fixed, and variable coils (families 50 and 51 respectively).
3. For grade 1 parts with magnet wire less than 30 AWG, measure DC resistance before and after thermal shocks. The resistance change shall not exceed ± 3 percent.
4. Dielectric withstanding voltage shall be measured at sea level and at high altitude. Test voltage and conditions shall be specified.

Table 06 Relay Screening Requirements (Page 1 of 3) (Notes 1, 2)

Inspection/Test	Test Methods, Conditions and Requirements (Note 3)	Notes	Part Type/Grade Level	
			1	2
Cleaning and Small Particle Inspection	Manufacturer's approved procedure	4	X	X
Visual Inspection (External)	Materials, design, construction, header glass, marking, and workmanship	5	X	X
Mechanical Inspections	Critical physical dimensions	6	X	X
Initial Electrical Inspections	Table 06A		X	
Vibrational Scan (Sinusoidal)	MIL-STD-202, Method 204 Specified test condition (amplitude, frequency range, sweep time and duration) Specified electrical load conditions Specified contact load Contact monitoring to specification Contact transfer to specification	7, 8, 9, 10	X	X
PIND	Manufacturer's approved procedure	11	X	X
Internal Moisture Detection	Relay dwell with coils deenergized for 30 minutes at 20±5°C IR ≥ 10,000 megohms (between all contact pins together and case) Energize relay coil at 140% rated voltage for 2.5 minutes. Repeat for two-coil latching relays. IR ≥ 10,000 megohms (between all contact pins together and case)		X	X
High Temperature Soak	16 hours at maximum rated operating temperature Energize coil at 120% rated voltage. For two coil latching relays, alternately energize coils 4 hours at a time.		X	X
Run-In Tests	<u>Low temperature run-in</u> 1 hour dwell at minimum rated operating temperature Pickup or latch/reset voltage to specification Contact loading: open circuit load voltage at 10 to 50 μV load current at 10 to 50μA Cycling rate: 60 actuations/minute (minimum) Specified number of cycles Grade 1 - 2500 cycles Grade 2 - 2500 cycles Miss level: 100 ohms maximum	12	X	X

See notes on page C-18.

Table 06 Relay Screening Requirements (Page 2 of 3) (Notes 1, 2)

Inspection/Test	Test Methods, Conditions and Requirements (Note 3)	Notes	Part Type/Grade Level	
			1	2
Run-In Tests (continued)	<p><u>High temperature run-in</u> Rated coil voltage for 1 hour at maximum rated operating temperature For two-coil latching relays, 30 minutes each coil Pickup or latch/reset voltage to specification Contact loading: open circuit load voltage at 10 to 50 μV load current at 10 to 50μA Cycling rate: 60 actuations/minute (minimum) Specified number of cycles Grade 1 - 2500 cycles Grade 2 - 2500 cycles Miss level: 100 ohms maximum</p> <p><u>Room temperature run-in</u> 1 hour dwell at 25\pm5°C Pickup or latch/reset voltage to specification Contact loading: open circuit load voltage at 10 to 50 μV load current at 10 to 50μA Cycling rate: 60 actuations/minute (minimum) Specified number of cycles Grade 1 - 2500 cycles Miss level: 100 ohms maximum</p>		X	X
Radiographic Inspection	MSFC-STD-355C		X	
Hermetic Seal	Fine leak: MIL-STD-202, Method 112 Test Condition C 1.0 X 10 ⁻⁸ cc/sec. or MIL-STD-883, Method 1014 Test Condition A1, A2, or B 1.0 X 10 ⁻⁸ cc/sec. Gross Leak: MIL-STD-883, Method 1014 Condition D		X	X
Final Electrical Inspections	Table 06A	13	X	X
Percent Defective Allowable (PDA)	Grade 1- 5% Grade 2- 10%	13	X	X

See notes on page C-18.

Table 06 Relay Screening Requirements (Page 3 of 3) (Notes 1, 2)

Notes:

1. This screening table is suitable for both low level and high level relays, latching and nonlatching. Unless otherwise specified, relays with dc resistive contact ratings up to and including 2 amperes shall be considered low level relays. Relays with dc resistive contact ratings higher than 2 amperes shall be considered high level relays.
2. Screening in accordance with MIL-R-39016, MIL-R-6106, MIL-R-83536, or GSFC S-311-P-754 is acceptable in lieu of the screening specified in this table for Grade 2.
3. It is the responsibility of the user to specify the test conditions and define the pass/fail criteria for each inspection. These values shall be based on the nearest equivalent military specification, the manufacturer's specification, or the application, whichever is most severe.
4. It is the responsibility of the user to approve manufacturer procedures for internal visual inspection and cleaning of relays prior to canning. Appendix A to MIL-R-83536 may be used as a guideline. These procedures must be documented, on file at the user's facility, and available for NASA review. The NASA/GSFC Parts Branch (Code 311) maintains a list of relay manufacturer approved procedures.
5. Header glass inspection shall be performed with microscopic power of at least 10X and shall include examinations for the following types of irregularities: blisters, foreign material, dark spots, cracks and chips. Meniscuses shall not extend up the terminal more than 0.20 inch or one-third the terminal diameter, whichever is greater.
6. A minimum of 3 relays shall be measured. In the event of a failure, the entire lot shall be screened for dimensions and rejects discarded.
7. All relays shall be vibrated in the direction of contact motion.
8. Contacts shall be monitored with an adequate test circuit to verify that no opening of closed contacts in excess of 10 microseconds, nor closing of open contacts in excess of 1 microsecond, occurs. The contact load shall be 10 mA maximum at 6 Vdc maximum.
9. Prior to removal from the test fixture, apply maximum over the temperature range pickup or latching voltage to the coil and verify that relay contacts have switched. Remove pickup voltage or apply reset voltage and verify that contacts have switched again. Failure of relay contacts to transfer in either direction shall be cause for rejection.
10. External visual examination required after testing to verify no evidence of mechanical damage.
11. It is the responsibility of the user to approve manufacturer procedures for particle impact noise detection (PIND). Appendix B to MIL-R-83536 may be used as a guideline. These procedures must be documented, on file at the user's facility, and available for NASA review. The NASA/GSFC Parts Branch (Code 311) maintains a list of relay manufacturer approved procedures for PIND testing.
12. The specified sequence (low temperature, high temperature, room temperature) is preferred. However, it is acceptable to perform the high temperature run-in prior to the low temperature run-in.
13. Only the final electrical inspection results shall be used to determine the defect rate for the PDA.

Table 06A Relay Electrical Inspections (Page 1 of 4) (Note 1)

Inspection/Test	Test Methods, Conditions and Requirements (Note 2)	Notes	Part Type/Grade Level	
			1	2
DC Coil Resistance	MIL-STD-202, Method 303		X	X
Static Contact Resistance or Contact Voltage Drop	<u>Low level relays</u> MIL-STD-202, Method 307 Test load: 10 mA maximum at 6 V maximum (dc or peak ac) No actuations prior to measurement Measurements between all contact pairs One measurement for each of three actuations (use average value) Static contact resistance to specification <u>High level relays</u> MIL-STD-202, Method 307 Test load: rated dc resistive contact current at 6 V maximum (dc or peak ac) No actuations prior to measurement Measurements between all contact pairs One measurement for each of ten actuations (use average value) Contact voltage drop to specification		X	X
Pickup, Hold, and Dropout Voltages or Latch/Reset Voltages	<u>Nonlatching relays</u> Gradually step or ramp coil voltage until the relay contacts switch Pickup voltage to specification Gradually reduce coil voltage to specified hold voltage No switching of contacts Gradually reduce coil voltage until contacts switch to their original state Dropout voltage to specification <u>Latching relays</u> Gradually step or ramp latch coil voltage until the relay contacts switch Latch voltage to specification Remove latching voltage Gradually step or ramp reset coil voltage until the relay contacts switch Reset voltage to specification	3	X	X

See notes on page C-21.

Table 06A Relay Electrical Inspections (Page 2 of 4) (Note 1)

Inspection/Test	Test Methods, Conditions and Requirements (Note 2)	Notes	Part Type/Grade Level	
			1	2
Operate and Release Time	Use oscilloscope or other acceptable means to time each pair of contacts Measurements shall be exclusive of bounce or stabilization times Contact load: 10 mA maximum at 6 V maximum (dc or peak ac) Alternately apply and remove rated coil voltage a total of 5 times Operate and release time to specification based on the average of 5 consecutive measurements	4	X	X
Contact Bounce Time	Use oscilloscope or other acceptable means to time each pair of contacts Contact load: 10 mA maximum at 6 V maximum (dc or peak ac) Alternately apply and remove rated coil voltage a total of 5 times Contact bounce time to specification based on the average of 5 consecutive measurements	5	X	X
Contact Stabilization Time (when specified)	Use oscilloscope or other acceptable means to time each pair of contacts Contact load: 50 mA maximum at 50 mV maximum (dc or peak ac) Alternately apply and remove rated coil voltage a total of 5 times Contact stabilization time to specification based on the average of 5 consecutive measurements	6	X	X
Dielectric Withstanding Voltage	MIL-STD-202, Method 301 Specified test voltage Leakage current to specification	7, 8, 9	X	X
Insulation Resistance	MIL-STD-202, Method 302 Test Condition A (relays with coil and contact ratings both < 60 volts) Test Condition B (other relays) Resistance (minimum) to specification	8	X	X
Coil Transient Suppression	Use oscilloscope or other acceptable means to observe magnitude of the induced voltage transient across the coil(s) Rated coil voltage The maximum of three consecutive readings shall be recorded Back EMF (induced voltage) to specification	10	X	X

See notes on page C-21.

Table 06A Relay Electrical Inspections (Page 3 of 4) (Note 1)

Inspection/Test	Test Methods, Conditions and Requirements (Note 2)	Notes	Part Type/Grade Level	
			1	2
Neutral Screen	Rated coil voltage to both coils simultaneously for a period of 10 milliseconds minimum Repeat three times Neutral screen to specification In the event of failure, apply a 10±1 ms pulse at maximum allowable latch voltage (at 25°C) Latch to specification Apply 10±1 ms pulse at maximum allowable reset voltage (at 25°C) Reset to specification	11, 12	X	X
Non-Make-Before-Break	Rated pickup, latch or reset voltage Contact load: 10 mA maximum at 6 V maximum (dc or ac peak) Energize and deenergize 10 consecutive cycles Non-make-before-break to specification		X	X

Notes:

1. This table is suitable for both low level and high level relays, latching and nonlatching. Unless otherwise specified, relays with dc resistive contact ratings up to and including 2 amperes shall be considered low level relays. Relays with dc resistive contact ratings higher than 2 amperes shall be considered high level relays.
2. It is the responsibility of the user to specify the test conditions and define the pass/fail criteria for each inspection. These values shall be based on the nearest equivalent military specification, the manufacturer's specification, or the application, whichever is most severe.
3. For screening, the mounting position of the relay is optional.
4. Release time is not applicable to latching relays.
5. A contact bounce shall be considered any occurrence equal to or greater than 90 percent of the open circuit voltage with a pulse width of 10 microseconds or greater. Lesser values are considered to be dynamic contact resistance.
6. Contact stabilization time is the maximum time allowed for the contacts to reach and maintain a static contact resistance state following the actual operate or release time of the relay. Essentially, it is the sum of the contact bounce time plus the time required for the dynamic contact resistance to stabilize to static contact resistance.
7. The DWV test duration shall be 5 seconds minimum.
8. Points of application for testing: (1) between case, frame or enclosure, and between all contacts in the energized and deenergized positions; (2) between case, frame or enclosure and coil(s); (3) between all contacts and coil(s); (4) between open contacts in the energized and deenergized positions; (5) between coils of dual-coil relays; (6) and between contact poles in the energized and deenergized positions.

Table 06A Relay Electrical Inspections (Page 4 of 4)

Notes (Continued):

9. External visual examination required after testing to verify no evidence of mechanical damage.
10. Applicable only to dc operated relays with diodes for coil transient voltage suppression.
11. Applicable only to latching relays.
12. A relay which will not assume a neutral position for three successive test cycles is considered an acceptable part and does not require further testing.

Table 07 Fixed Resistor Screening Requirements (Page 1 of 2)

Inspection/Test	Test Methods, Conditions and Requirements (Note 1)	Notes	Part Type/Grade Level					
			Composition		Film		Wirewound	
			1	2	1	2	1	2
Precap Visual Inspection	<u>Networks</u> : Particles, metallization (scratches, voids, adherence, bridging, alignment, corrosion, probe marks), laser trim faults, bonding pad defects, oxide defects <u>Others</u> : Not applicable	2, 3			X			
Visual Inspections	Materials, design, construction, marking, and workmanship	4	X	X	X	X	X	X
Mechanical Inspections	Critical physical dimensions	5	X	X	X	X	X	X
Initial dc Resistance	MIL-STD-202, Method 303	6, 7, 8	X	X	X	X	X	X
Thermal Shock	MIL-STD-202, Method 107 Grade 1 - 25 cycles Grade 2 - 10 cycles High temperature - max. rated operating Low temperature - min. rated operating	9, 10			X	X		
Power Conditioning	MIL-STD-202, Method 108 Specified rated wattage multiple Specified temperature Specified time If time ≤ 24 hours: continuous operation If time > 24 hours: 1.5 hours on, 0.5 hours off	9, 10 11, 12			X	X	X	X
Final dc Resistance	MIL-STD-202, Method 303 Resistance and ΔR to specification				X	X		

See notes on page C-24.

Table 07 Fixed Resistor Screening Requirements (Page 2 of 2)

Inspection/Test	Test Methods, Conditions and Requirements (Note 1)	Notes	Part Type/Grade Level					
			Composition		Film		Wirewound	
			1	2	1	2	1	2
Hermetic Seal	Fine leak: MIL-STD-202, Method 112 Test Condition C 5.0 X 10 ⁻⁷ cc/sec. (networks) 1.0 X 10 ⁻⁸ cc/sec. (others) Gross Leak: MIL-STD-883, Method 1014 Condition D	13			X	X		
Radiographic Inspection	MSFC-STD-355C	14			X		X	
Percent Defective Allowable (PDA)	Grade 1 - 5% Grade 2 - 10%	15	X	X	X	X	X	X

Notes:

1. It is the responsibility of the user to specify the test conditions and define the pass/fail criteria for each inspection. These values shall be based on the nearest equivalent military specification, the manufacturer's specification, or the application, whichever is most severe.
2. Examination shall be performed using binocular magnification of 50X to 100X.
3. If solder is used for internal connections, it shall have a liquid point not less than +280°C.
4. Small resistors, such as chip resistors, shall be examined using 30X to 60X magnification, but in case of conflict, 30X shall be the referee power.
5. A minimum of 3 resistors shall be measured. In the event of a failure, the entire lot shall be screened for dimensions and rejects discarded.
6. The test voltage must be specified in the SCD or by the manufacturer (commercial parts).
7. For networks, unless otherwise specified, individual resistive elements shall be isolated (whenever possible) to minimize computation of pin-to-pin resistance values.
8. Out of tolerance composition resistors shall be baked in accordance with the SCD or manufacturer's instructions and then remeasured. Resistors that remain out of tolerance after baking shall be considered failures.
9. ΔR is optional after this inspection if ΔR is specified for thermal shock and conditioning combined.
10. External visual examination required after testing to verify no evidence of mechanical damage.
11. Not applicable to chip resistors. Conditioning time for film networks with internal solder terminations shall be 250 hours minimum.
12. Unless otherwise specified, the manufacturer's maximum rated continuous dc working voltage should not be exceeded during conditioning as determined by $V = \sqrt{PR}$.
13. Applicable only to hermetically sealed networks and high stability film resistors.
14. Not applicable to composition, chip or network resistors.
15. Marking and cosmetic defects shall not be counted for purposes of establishing the defect rate for PDA.

Table 07A Variable Resistor Screening Requirements (Page 1 of 3)

Inspection/Test	Test Methods, Conditions and Requirements (Note 1)	Notes	Part Type/Grade Level			
			Non-Wirewound		Wirewound	
			1	2	1	2
Visual Inspections	Materials, design, construction, marking, and workmanship		X	X	X	X
Mechanical Inspections	Critical physical dimensions	2	X	X	X	X
Thermal Shock	MIL-STD-202, Method 107 Grade 1 - 25 cycles Grade 2 - 10 cycles High temperature - max. rated operating Low temperature - min. rated operating Total resistance and ΔR to specification Setting stability ($\Delta\%$) to specification Continuity check	3, 4, 5, 6	X	X	X	X
Conditioning	MIL-STD-202, Method 108 Specified rated wattage multiple Specified temperature 100 hours minimum (Grade 1), 1.5 hours on, 0.5 hours off 50 hours minimum (Grade 2), 1.5 hours on, 0.5 hours off Total resistance and ΔR to specification	3, 4, 7	X	X	X	X
Contact Resistance Variation or Peak Noise	Contact resistance variation to specification, or Peak noise (resistance variation) to specification	8	X	X	X	X
Immersion	Gross leak: MIL-STD-202, Method 112, Test Condition D Modify as follows: 1. Precondition resistors at +125°C for 15±2 minutes. 2. Stabilize at room temperature for 15±2 minutes. 3. Immerse into fluorocarbon bath held at +85°C to +90°C, shake for 5 seconds maximum, then keep resistors submerged for a period of 1 minute ±5 seconds. 4. Discard resistors with inadequate seals as evidenced by a continuous stream of bubbles emanating from any concentrated point on the resistor.		X	X	X	X

See notes on page C-26.

Table 07A Variable Resistor Screening Requirements (Page 2 of 3)

Inspection/Test	Test Methods, Conditions and Requirements (Note 1)	Notes	Part Type/Grade Level			
			Non-Wirewound		Wirewound	
			1	2	1	2
Actual Effective Electrical Travel	Number of turns or angular degrees to specification	9	X		X	
Absolute Minimum Resistance	Resistance to specification	10			X	X
End Resistance	Resistance to specification	11	X	X	X	X
DWV	MIL-STD-202, Method 301 Specified test voltage Between terminals tied together and all external metal portions Leakage current to specification	3	X		X	
IR	MIL-STD-202, Method 302, Test Condition A or B Between terminals tied together and all external metal portions Resistance (minimum) to specification		X		X	
Torque	Operating torque to specification Clutch to specification (when applicable) Stop strength to specification (when applicable)	12, 13, 14	X	X	X	X
Radiographic Inspection	MIL-STD-202, Method 209	15	X		X	
Percent Defective Allowable (PDA)	Grade 1 - 5% Grade 2 - 10%	16	X	X	X	X

Notes:

1. It is the responsibility of the user to specify the test conditions and define the pass/fail criteria for each inspection. These values shall be based on the nearest equivalent military specification, the manufacturer's specification, or the application, whichever is most severe.
2. A minimum of 3 resistors shall be measured. In the event of a failure, the entire lot shall be screened for dimensions and rejects discarded.
3. External visual examination required after testing to verify no evidence of mechanical damage.
4. Total resistance shall be measured between the end terminals with the movable contact arm positioned against a stop. The positioning of the contact arm and terminal shall be the same for all subsequent measurements of total resistance on the same specimen. The test voltage for total resistance measurements must be specified in the SCD or by the manufacturer (commercial parts).
5. Setting stability in percent shall be determined by placing the movable contact arm at approximately 40% of the actual effective electrical travel. A dc test potential shall be applied between the end terminals. The measured voltage between the contact arm and one end terminal (E1) and the measured voltage between the end terminals (E2) shall be used to determine the setting stability in percent using the following formula:

$$\text{Setting stability (\%)} = (E1 \times 100)/E2.$$

Table 07A Variable Resistor Screening Requirements (Page 3 of 3)

Notes (Continued):

6. There shall be no abrupt discontinuities, especially when the direction of travel is reversed, as the contact arm is rotated at a uniform rate back and forth two times across the actual effective electrical travel. During rotation, a suitable electrical device shall be connected between the contact arm and either end terminal to monitor the change in resistance or voltage.
7. The conditioning voltage shall be applied between the end terminals. Unless otherwise specified, the manufacturer's rated continuous dc working voltage should not be exceeded during conditioning as determined by $V = \sqrt{PR}$.
8. Contact resistance variation or peak noise is a measure of any spurious variations in the electrical output as the contact arm is rotated. It is expressed either as a maximum resistance variation limit, or as a percentage of the total resistance output for the specified rotational travel increment. The output can be observed on an oscilloscope or strip chart recorder, and either method requires calibration to obtain a measure of the peak resistance spikes observed during contact arm rotation. The contact arm shall be rotated in both directions through 90 percent of the actual effective electrical travel for a total of 6 cycles. Only the last 3 cycles shall count in determining whether or not a spurious resistance variation is observed at least twice in the same location, exclusive of the roll-on or roll-off points where the contact arm moves between the termination and resistance element.
9. The actual effective electrical travel shall be measured by placing the resistor in a suitable device and circuit which will indicate both angular position of the operating shaft and electrical output. The actual effective electrical travel will be the number of turns, or degrees of rotation, in which a change in contact arm position gives a measurable change in electrical output.
10. The contact arm shall be positioned at the extreme counterclockwise limit of mechanical travel, and the resistance shall be measured between the contact arm and corresponding end terminal. Caution: do not exceed rated current during this measurement.
11. The contact arm shall be so positioned at one end of the resistance element so that a minimum value of resistance can be determined. The same procedure shall be followed for the other end of the resistance element. Caution: do not exceed rated current during this measurement.
12. The torque required to move the contact arm on the resistance element shall be determined at approximately 10, 50, and 90 percent of actual effective electrical travel by the torque wrench method or any suitable equivalent.
13. If the resistor contains a clutch mechanism, the contact arm shall be adjusted to each extreme limit of mechanical travel, and sufficient torque shall be applied to the actuator to permit the contact arm to idle for 25 complete mechanical turns. During idle, a suitable electrical indicating device connected between the contact arm terminal and an adjacent end terminal shall be observed for electrical continuity. After idle, the contact arm shall be rotated in the opposite direction, and the indicating device shall be observed to determine whether the contact arm actually reversed direction.
14. When stop strength is specified, the contact arm shall be rotated to each extreme of mechanical rotation with the specified torque applied through the operating shaft to the stop.
15. The SCD must detail the complete procedure for examining resistors for internal defects, such as contact arm misalignment, resistive element flaws, particles, etc., via radiographic inspection.
16. Marking or cosmetic defects shall not be counted for purposes of establishing the defect rate for PDA.

Table 08 Diode Screening Requirements

Inspection/Test	MIL-STD-750 Methods	MIL-STD-750 Conditions and Requirements	Grade 1	Grade 2
1. Internal Visual	2073/2074		X	X
2. Temperature Cycling	1051	Condition G (-55 °C to +150 °C) or max storage temperature whichever is less No dwell is required at 25°C. 20 cycles, t (extreme) ≥ 10 min.	X	X
3. Constant Acceleration	2006	20,000 g's in Y ₁ Direction except at 10,000 g's for devices with power rating ≥ 10 Watts @ T _C = 25 °C. Not required for metallurgically bonded diodes.	X	X
4. PIND	2052	Condition A. Not required for non-cavity diodes.	X	X (Note 1)
5. Instability shock a. FIST b. BIST	2081 2082	Shock test is required only for Axial Lead Diodes. Omit FIST for temperature compensated reference diode.	X	
6. Serialization			X	X
7. Initial Electrical		Read and record delta parameters per Table 8A on next page	X	X
8. Burn-In	1038	Conditions A and/or B per Table 8A on next page. Duration (hours) for HTRB/ Power Burn-in	X 48/240	X 48/160
9. Final Electrical		See Table 08A	X	X
10. Calculate Deltas		See Table 08A	X	
11. Percent Defective Allowable		PDA applies to DC measurements @ 25 °C and delta limits (when applicable).	5%	10%
12. Hermetic Seal a. Fine Leak b. Gross Leak	1071	G or H. Not required for double-plug diodes C or K	X	X
13. Radiographic	2076		X	
14. External Visual	2071		X	X

Note:

1. When procured directly from the manufacturer, JANTXV/ JANTX diodes should be procured with PIND testing per MIL-STD-19500, Paragraph 4.6.3.4.

Table 08A Burn-In And Electrical Measurement Requirements For Diodes

Diode Types	Required Burn-In		Delta Parameters	Electrical Measurements (Notes 1, 2, and 3)
	HTRB (Condition A)	Power (Condition B)		
Rectifier (Power, Fast Recovery, High Voltage)	80% rated V_{RM} (Note 4) $125^{\circ}C \leq T_A \leq 150^{\circ}C$	60 Hz Sinewave Rated V_{RWM} and I_O $T_A = 25^{\circ}C$	ΔV_F ΔI_R	$V_F, I_R, V_R, V_{BR}, I_{FSM}$ t_{rr}, C_j
Switching (General purpose, Schottky, RF, PIN)	80% rated V_{RM} $125^{\circ}C \leq T_A \leq 150^{\circ}C$	60 Hz Sinewave Rated V_{RWM} and I_O $T_A = 25^{\circ}C$	ΔV_F ΔI_R	$V_F, V_R, V_{BR}, I_R,$ $t_{rr}, \tau, C_j, P_o/P_i$
Zener (Voltage Reference)	Not Applicable	Specify I_Z to meet rated P_d $T_A = 125^{\circ}C$	ΔV_Z	V_F, V_Z, I_Z $Z_Z, \alpha V_Z$
Current Regulator Diode	Not required	Rated V_{POV} $T_A = 25^{\circ}C$	ΔI_s	$V_L, Z_S, Z_K, V_s, I_s, \alpha I_s,$
Transient Suppressor Diode	80% rated V_{RWM} $125^{\circ}C \leq T_A \leq 150^{\circ}C$	Specify $I_p, T_p,$ number of pulses $T_A = 25^{\circ}C$ (Note 5)	ΔV_{BR} ΔI_R	$V_{BR}, V_{CM}, I_{SM}, I_R.$
Light Emitting Diode	Not Applicable	Rated I_F $T_A = 25^{\circ}C$	ΔV_F ΔI_V	I_V, I_R, V_F C_T
Tunnel diode (Microwave)	Rated V_R $125^{\circ}C \leq T_A \leq 150^{\circ}C$	Specify I_F & V_F to meet max. P_d $T_A = 25^{\circ}C$	ΔV_P ΔV_R	I_p, I_V, V_R, V_F, V_V C_T
Varactor (Tuning)	80% rated V_{RM} $125^{\circ}C \leq T_A \leq 150^{\circ}C$	Not Required	ΔI_R ΔC_T	I_R, V_{BR} $C_C, C_T, Q, C_{t1}, L_S, C_{t2}$
Thyristor (SCRs)	80% rated V_{RM} 80% rated V_{DM} $125^{\circ}C \leq T_A \leq 150^{\circ}C$	Rated V_{DWM} & V_{RWM} . Specify V_{GT} & V_{GQ} . (Note 6) $T_A = 25^{\circ}C$	ΔI_{DM} ΔI_{RM}	$I_{DM}, I_{GM}, I_{GT}, I_L, I_{RM}, V_{BR}, V_{GT},$ $dV/dt, t_{on}, t_{off}$

Notes:

1. See MIL-S-19500, Appendix B for symbol definitions.
2. Minimum required parameters are specified. When necessary, application critical parameters not listed in the table shall also be measured.
3. All DC parameters shall be tested at 25°C, at minimum and at maximum operating temperatures. All AC parametric measurements shall be performed at the required 25°C.
4. Case mounted rectifiers with I_O rated > 10 A @ $T_c = 100^{\circ}C$ do not require HTRB.
5. Refer to slash sheets (e.g. /516) for the unique power burn-in sequence of transient suppressor diodes.
6. Power burn-in is applied only to SCR specifically designed with gate turn-off control; otherwise, use method 1040, condition A or B.

Table 09 Transistor Screening Requirements

Inspection/Test	MIL-STD-750 Methods	MIL-STD-750 Conditions and Requirements	Grade 1	Grade 2
1. Internal Visual	2072 2070 2069	General - purpose transistors RF transistors Power FETs	X	X
2. Temperature Cycling	1051	Condition G (-55 °C to +150 °C) or max storage temperature whichever is less. No dwell is required at 25°C. 20 cycles, t (extreme) ≥ 10 minutes.	X	X
4. Constant Acceleration	2006	20,000 g's in Y ₁ Direction except at 10,000 g's for devices with power rating ≥ 10 Watts @ T _c = 25 °C. Not required for metallurgically bonded diodes.	X	X
5. PIND	2052	Condition A. Not required for optical coupled isolators.	X	X (Note 1)
8. Serialization			X	X
9. Initial Electrical		Read and record delta parameters per Table 09A on next page	X	X
10. Burn-In	1039	Conditions A and B per Table 09A on next page. Duration (hours) for HTRB/ Power Burn-in	X 48/240	X 48/160
11. Final Electrical		See Table 09A	X	X
12. Calculate Delta		See Table 09A	X	X
13. Percent Defective Allowable		PDA applies to the DC measurements @ 25 °C and delta limits (when applicable).	5%	10%
14. Hermetic Seal a. Fine Leak b. Gross Leak	1071	G or H C or K	X	X
15. Radiographic	2076		X	
16. External Visual	2071		X	X

Note:

- When procured directly from the manufacturer, JANTXV/JANTX transistors should be procured with PIND testing per MIL-STD-19500, Paragraph 4.6.3.4.

Table 09A Burn-In and Electrical Measurement Requirements for Transistors

Transistor Type	Required Burn-in		Delta Parameters	Electrical Measurements (Notes 1,2, and 3)
	HTRB (Condition A)	Power (Condition B)		
Bipolar Transistors (Switching, Low/ High Power, Dual, General Purpose.)	80% rated V_{CBO} $125^{\circ}C \leq T_A \leq 150^{\circ}C$	Specify V_{CB} or V_{CE} to meet max P_T $T_A = 25^{\circ}C$	ΔI_{CBO} or ΔI_{CEO} Δh_{FE}	I_{CB} , I_{CEO} , I_{CBO} , I_{EBO} , $V_{(BR)CEO}$, $V_{(BR)CBO}$, $V_{(BR)EBO}$, $V_{(BR)CES}$, $V_{CE(SAT)}$, $V_{BE(SAT)}$, h_{FE} , t_{on} , t_{off} , t_s , t_f , h_{fe} , C_{obo} , C_{ibo}
Bipolar Transistors (RF, High-Frequency)	80% rated V_{CBO} $125^{\circ}C \leq T_A \leq 150^{\circ}C$	Specify V_{CB} to meet max P_T $T_A = 25^{\circ}C$	ΔI_{CEO} Δh_{FE}	I_{CEO} , $V_{(BR)CEO}$, $V_{(BR)CBO}$, $V_{(BR)EBO}$ $V_{CE(SAT)}$, h_{FE} G_{PE} , NF , h_{fe} , η , C_{obo}
Junction Field Effect (JFET)	80% rated V_{GS} $V_{DS} = 0$ $125^{\circ}C \leq T_A \leq 150^{\circ}C$	80% rated V_{GS} Specify V_{DS} to meet max P_T $T_A = 25^{\circ}C$	ΔI_{DSS} or ΔI_{GSS} Δy_{fs}	$V_{DS(ON)}$, $V_{GS(OFF)}$, $V_{(BR)GSS}$, I_{GSS} , I_{DSS} , C_{iss} , C_{riss} , y_{fs} , y_{os} .
MOSFET	80% rated V_{DS} $V_{GS} = 0V$ $T_A = 125^{\circ}C$	80% of rated V_{GS} $V_{DS} = 0V$ $T_A = 125^{\circ}C$	ΔI_{DSS} or ΔI_{GSS} $\Delta V_{GS(TH)}$ $\Delta r_{ds(on)}$	$V_{(BR)DSS}$, $V_{GS(TH)}$, $V_{DS(ON)}$, V_{SD} , $r_{ds(on)}$, t_{on} , t_{off} , t_{tr} , C_T .
Darlington	80% rated V_{CBO} $125^{\circ}C \leq T_A \leq 150^{\circ}C$	Specify V_{CB} or V_{CE} to meet max P_T $T_A = 25^{\circ}C$	Δh_{FE} ΔI_{CE}	$V_{CE(SAT)}$, $V_{BE(SAT)}$, $V_{BE(TH)}$, $V_{(BR)CEO}$, I_{CEO} , I_{EBO} , I_{CE} h_{FE} , t_{on} , t_{off} , C_{obo} .
Optocoupler	$I_F = 0$ 80% Rated V_{CBO} $T_A = 125^{\circ}C$	$I_F =$ rated max Specify V_{CE} to meet max P_T $T_A = 25^{\circ}C$	Δh_{FE} $\Delta I_{C(OFF)}$ $\Delta I_{C(ON)}$	$V_{CE(SAT)}$, $V_{(BR)CEO}$, V_F $I_{C(OFF)}$, $I_{C(ON)}$, I_R , h_{FE} , t_r , t_f , C_{obo} .

Notes:

1. See MIL-S-19500, Appendix B for symbol definitions.
2. Recommended electrical parameters are specified. Since electrical parameters are device dependent, the conditions and limits pertaining to a device type shall be specified in a detail specification.
3. All DC parameters shall be tested at 25°C, at minimum operating temperature and at maximum operating temperature. All AC parametric measurements shall be made at the required 25°C.

Table 10 Monolithic Integrated Circuit Screening Requirements

Inspection/ Test	Methods	MIL-STD-883 Conditions and Requirements	Grade 1	Grade 2
1. Wafer Acceptance	5007		X	
2. Nondestructive Bond Pull	2023		X	
3. Internal Visual	2010	Condition A or B (Note 1).	X	X
4. Temperature Cycling	1010	Condition C (-65 °C to + 150 °C) in N ₂ atmosphere. 20 cycles.	X	X
5. Constant Acceleration	2001	Condition E (Note 2). Y ₁ orientation only.	X	X
6. PIND	2020	Condition A.	X	X
7. Radiographic	2012	1 view for Quad Flat Pack and Leadless Chip Carrier. 2 views for other package styles. Can be performed at any time after PIND.	X	
8. Serialization			X	
9. Initial Electrical Measurements		Read and record delta parameters per Table 10A.	X	X
10. Burn-In (Note 3)	1015	Condition C and/or D per Table 10A. Duration (hours) for Static/Dynamic burn-in as required in Table 10A.	X 72/240	X 160
11. Final Electrical Measurements		Per Table 10A.	X	X
12. Calculate Deltas		See Table 10A.	X	
13. Percent Defective Allowable		PDA applies to delta, selected DC and functional tests at test temperature of 25 °C.	Δ+DC ≤5% Functional ≤ 3%	DC ≤10%
14. Hermetic Seal a. Fine Leak b. Gross Leak	1014	Condition A or B. Condition C.	X	X
15. External Visual	2009	3 X to 10X.	X	X

Notes:

1. Destructive Physical Analysis may be performed to the requirements of S311-M-70 in lieu of internal visual for devices used in Grades 2 applications.
2. For packages having a cavity perimeter of 2 inches or more in total length, or having a mass greater than 5 grams, test condition D can be used.
3. A dynamic burn-in or a static burn-in shall be performed in accordance with Table 10A. Static and dynamic burn-in is required for Grade 1 parts when so indicated in Table 10A. A dynamic or static burn-in shall be performed in accordance with Table 10A for Grade 2 parts.

Table 10A Burn-In and Electrical Measurement Requirements for Monolithic ICs (Page 1 of 4)

IC Type	Required Burn-In (Note 4)		Delta	Electrical Measurements (Notes 1, 2, 3)
	Static (Condition C)	Dynamic (Condition D)		
Digital Bipolar & Digital MOS/ BiCMOS: (Note 6) LOGIC (Gates, Buffers, Flip-Flops, Multiplexers, Registers and Counters) RAMs FIFOs Microprocessors Interface Peripherals ASICs FPGA, PROM, PLA (Note 5)	Not required for Digital Bipolar Technology. Required for Digital MOS Technology. $T_A \geq 125\text{ }^\circ\text{C}$ $V_{in} = V_{DD}$ across one-half input pins and V_{SS} across the remaining inputs. $V_{out} = 0.5 V_{DD}$ through R_L	Required for both technologies. $T_A \geq 125\text{ }^\circ\text{C}$ V_{in} = Square wave, 50% Duty Cycle to input pins and control pins. Frequency= 100 Hz to 1 Mhz. $V_{out} = V_{CC} / 2$ or $V_{DD} / 2$ through R_L .	ΔI_{CC} or ΔI_{DD}	DC: $V_{IC}, V_{OH}, V_{OL}, I_{CC}(I_{EE}), I_{IL}, I_{IH}, I_{DD}, I_{OZL}, I_{OZH}, I_{OS}$ AC: $T_{PLH}, T_{PHL}, T_{TLH}, T_{THL}, T_{PZH}, T_{PHZ}, T_{PLZ}, T_{PZL}, T_A, T_S, T_H$ Functional Tests: a) for simple logic devices, verify truth table b) for complex logic devices such as ASIC, FPGA, microprocessors, functional testing includes fault coverage calculations required per Mil-Std-883, Method 5012. c) for PROMs, check fuse map; for RAMs, perform pattern sensitive tests such as March, galpat, etc.
Linear MOS, Bipolar, and Bi-FET: (Note 7) Op-Amp, Instrument Amplifiers, S/H, and Comparator	$T_A \geq 125\text{ }^\circ\text{C}$ V_{out} = Terminated to ground through R_L	$T_A \geq 125\text{ }^\circ\text{C}$ V_{in} = Square wave or sinewave $F = 10\text{ Hz to } 100\text{ KHz}$, 50% duty cycle V_{out} = Terminated to ground through R_L	ΔI_{IB} ΔI_{IO} ΔV_{IO}	DC: $I_{CC}, I_{EE}, I_{IO}, V_{IO}, V_{OPP}, A_V, CMRR, PSRR$ AC: Slew rate

See notes on page C-35.

Table 10A Burn-In and Electrical Measurement Requirements for Monolithic ICs (Page 2 of 4)

IC Type	Required Burn-In (Note 4)		Delta	Electrical Measurement (Notes 1, 2, 3)
	Static (Condition C)	Dynamic (Condition D)		
Linear MOS, Bipolar and JFET: (Note 7) Line Drivers and Receivers	$T_A \geq 125\text{ }^\circ\text{C}$ $V_{in} = V_{DD}$ max across one-half input pins and V_{SS} across the remaining inputs.	$T_A \geq 125\text{ }^\circ\text{C}$ V_{in} = Square wave at a specified Vdc $V_{out} = V_{CC}$ through R_L	ΔI_{CC} ΔI_{IH}	DC: $V_{OH}, V_{OL}, I_{CC}, I_{IL}, I_{IH}, I_{OS}$ AC: $T_{PLH}, T_{PHL}, T_{TLH}, T_{THL}$ Functional Test: verify truth table
Linear MOS, Bi-FET, and Bipolar: (Note 6) Analog Switches and Multiplexers	$T_A \geq 125\text{ }^\circ\text{C}$ $V_{in} = V_{DD}$ max across one-half of inputs and V_{SS} across the other remaining inputs. $V_{out} = \pm V_{CC}$ through R_L	$T_A \geq 125\text{ }^\circ\text{C}$ V_{in} = Square wave $F = 100\text{ KHz}$ and 50% duty cycle $V_{out} = \pm V_{CC}$ through R_L	I_{CC} $I_{D(OFF)}$ $I_{S(OFF)}$ $R_{(ON)}$	DC: $I_{CC}, I_{D(ON)}, R_{(ON)}, I_{D(OFF)}, I_{S(ON)}, I_{S(OFF)}$ AC: $T_{(ON)}, T_{(OFF)}$ break- before- make- time
Linear Bipolar: Voltage Regulators	$T_A \geq 125\text{ }^\circ\text{C}$ V_{out} = Terminated to ground through R_L	Not required	ΔI_{SCD} ΔV_{OUT}	DC: I_{CC}, V_{OUT}, I_{OS} , line/load regulation
Linear Bipolar: Pulse-width-modulator	Not required	$T_A \geq 125\text{ }^\circ\text{C}$ V_{out} = Terminated to ground through R_L R_{ext}, C_{ext} connected if applicable.	ΔI_{IO} ΔV_{REF}	DC: $V_{REF}, I_{IB}, I_{IO}, I_{OS}, V_{IO}, V_{OL}, V_{OH}, A_V, CMRR, PSRR}$ AC: T_R, T_F, f_{OSC}
Darlington Transistor Array	$T_A \geq 125\text{ }^\circ\text{C}$ $V_{out} = 15\text{ Vdc}$ through R_L	Not required	ΔI_{CEX} Δh_{FE}	DC: $V_{CE(SAT)}, V_F, I_{CEX}, I_F$ AC: h_{FE}, t_{PHL}, t_{PLH}
Linear CMOS Timers	$T_A \geq 125\text{ }^\circ\text{C}$ $V_{out} = V_{CC}$ through R_L	Not required	ΔI_{CEX} ΔV_{OH} ΔV_{OL}	DC: $V_{TRIG}, V_{TH}, V_R, V_{OL}, V_{OH}, V_{SAT}, I_{CC}, I_{TRIG}, I_{TH}, I_R, I_{CEX}$ AC: T_{TLH}, T_{THL}

See notes on page C-35.

Table 10A Burn-In and Electrical Measurement Requirements for Monolithic ICs (Page 3 of 4)

IC Type	Required Burn-In (Note 4)		Delta	Electrical Measurement (Notes 1, 2, 3)
	Static (Condition C)	Dynamic (Condition D)		
Linear MOS and Bipolar: Active Filters	Not required	$T_A \geq 125\text{ }^\circ\text{C}$ V_{in} = Sine wave at Frequency $< f_O$ V_{out} = Terminated to ground through R_L	ΔI_{CC} ΔV_{OS}	DC: I_{CC} , I_{SS} , V_{OS} AC: f_O , Q, input frequency range
Mixed Signal MOS, Bi-CMOS and Bipolar: (Note 7) Analog to Digital (A/D) Converters.	$T_A \geq 125\text{ }^\circ\text{C}$ V_{in} = Max analog dc input V_{out} = $V_{CC}/2$ through R_L	$T_A \geq 125\text{ }^\circ\text{C}$ V_{in} = Analog input to generate maximum digital codes. V_{out} = $V_{CC}/2$ through R_L	ΔI_{CC} ΔI_{EE} ΔV_{IO}	DC: V_{REF} , V_{OH} , V_{OL} , V_{IO} , I_{CC} , I_{EE} , I_{IL} , I_{IH} , I_{OZL} , I_{OZH} , I_{OS} , Zero Error, Gain Error, Linearity Error. AC: T_C , T_S , T_H Functional Test: Verify codes
Mixed Signal MOS, Bi-CMOS and Bipolar (Note 7) Digital to Analog (D/A) Converters.	$T_A \geq 125\text{ }^\circ\text{C}$ V_{in} = V_{DD} on one-half data inputs and V_{SS} on remaining inputs. V_{out} = Terminated to ground thru R_L	$T_A \geq 125\text{ }^\circ\text{C}$ V_{in} = Apply appropriate digital codes for all inputs and for control signals. V_{out} = Terminated to ground through R_L .	ΔI_{CC} ΔI_{EE}	DC: I_{CC} , I_{EE} , I_{IL} , I_{IH} , I_{OZL} , I_{OZH} , I_{OS} , Zero Error, Gain Error, Linearity Error, PSRR AC: T_C , T_S , T_H Functional Test: Verify codes

Notes:

1. See MIL-S-1331 for symbol definitions.
2. These are typically recommended electrical parameters. Since electrical parameters are device dependent, refer to detail specifications for actual DC and AC parametric test conditions and limits.
3. For digital devices, all DC parameters, functional tests, and switching tests shall be tested at 25°C, at minimum operating temperature and at maximum operating temperature. AC tests (e.g C_{IN}) are tested initially and after any design or process changes.
For linear devices, all DC parameters shall be tested at 25°C, at minimum operating temperature and at maximum operating temperature. All AC and switching tests shall be performed at 25°C.
4. Static and Dynamic burn-in shall be performed at maximum recommended operating supply voltage with V_{in} and R_L selected to assure that the junction temperature shall not exceed T_{jmax} specified for the device type.
5. For one-time programmable devices, (e.g. PROMs, PALs and FPGAs) dynamic burn-in shall be performed on programmed devices with user application specific burn-in circuit. The post burn-in should include DC, AC, and functional tests for user's program verification.
6. Dynamic burn-in required for Grade 2 parts.
7. Static or dynamic burn-in acceptable for Grade 2 parts.

Table 10B Hybrid Integrated Circuit Screening Requirements

Inspection/ Test	Methods	MIL-STD-883 Conditions and Requirements	Grade 1	Grade 2
1. Pre-seal Burn-in	1030		Optional	Optional
2. Nondestructive Bond Pull	2023	PDA \leq 2% or 1 wire.	X	
3. Internal Visual	2017	Condition A or B. (Note 1)	X	X
4. Stabilization Bake	1008	Condition C	X	X
4. Temperature Cycling	1010	Condition B (-55 °C to +125 °C) for 10 cycles	X	X
5. Constant Acceleration	2001	Condition A Y ₁ orientation only	X	X
6. PIND	2020	Condition A or B.	X	X
7. Radiographic	2012	Can be performed at any sequence after PIND.	X	
8. Serialization			X	
9. Initial Electrical Measurements		Electrical measurements and delta parameters are done per applicable device specification (Note 2).	X	X
10. Burn-In	1015	Condition A, B, C, or D @ T _A \geq 100 °C. Duration (hours) for Static /Dynamic burn-in (Note 2, 3).	X 160/160	X 160
11. Final Electrical Measurements		For Grade 1, interim electrical tests shall be performed after the first 160-hour burn-in.	X	X
12. Calculate Deltas		Per applicable device specification	X	
13. Calculate PDA		PDA applies to selected DC tests and delta for Grade 1 during the second burn-in only.	Δ +DC \leq 2%	DC \leq 10%
14. Hermetic Seal a. Fine Leak b. Gross Leak	1014	Condition A or B Condition C	X	X
15. External Visual	2009	3 X to 10X	X	X

Notes:

1. Destructive Physical Analysis may be performed to the requirements of S311-M-70 in lieu of internal visual for devices used in Grades 2.
2. Burn-in and electrical measurements are not included for hybrids due to many customer designs and many different functional configurations; they shall be specified in the detail specifications or altered item drawings.
3. For Grade 1 parts, the burn-in period shall be divided into two successive 160- hour minimum burn-in; included in that total 320-hour time may be a combined static and dynamic configurations. For Grade 2 parts, only one burn-in is required, and it can be either static mode or dynamic mode.

Table 14 Thermistor Screening Requirements (Page 1 of 3)

Inspection/Test	Test Methods, Conditions and Requirements (Note 1)	Notes	Part Type/Grade Level			
			Positive Temperature Coefficient		Negative Temperature Coefficient	
			1	2	1	2
Visual Inspections	Materials, design, construction, marking, and workmanship		X	X	X	X
Mechanical Inspections	Body and lead dimensions to specification	2	X	X	X	X
Zero-Power Resistance	MIL-STD-202, Method 203 Zero-power resistance at specified reference temperature Zero-power resistance at +125°C Zero-power resistance at specified reference temperature ΔR (zero-power) to specification	3, 4, 5	X	X	X	X
Thermal Shock	MIL-STD-202, Method 107 Grade 1 - 25 cycles Grade 2 - 10 cycles High temperature - +125°C Low temperature - min. rated operating	4, 5, 6	X	X	X	X
High Temperature Storage	+125°C, 100 hours, no load	4, 5, 6	X	X	X	X
Zero Power Resistance	MIL-STD-202, Method 203 Zero-power resistance at specified reference temperature ΔR (zero-power) to specification	3, 4, 5	X	X	X	X
Insulation Resistance	MIL-STD-202, Method 302 Between leads and conductive material surrounding body Specified minimum resistance		X	X	X	X

See notes on page C-38.

Table 14 Thermistor Screening Requirements (Page 2 of 3)

Inspection/Test	Test Methods, Conditions and Requirements (Note 1)	Notes	Part Type/Grade Level			
			Positive Temperature Coefficient		Negative Temperature Coefficient	
			1	2	1	2
Resistance Temperature Characteristic	Specified temperature points Stabilization time ≥ 10 times the thermal time constant Zero-power resistance at each temperature point Resistance curve to specification within tolerance limits at each temperature point Temperature points: <u>Grade 1</u> - reference temperature, each temperature extreme, and a minimum of 5 points between reference temperature and each temperature extreme <u>Grade 2</u> - reference temperature, each temperature extreme, and a minimum of 3 points between reference temperature and each temperature extreme	3, 4, 5	X	X	X	X
Percent Defective Allowable (PDA)	Grade 1- 5% Grade 2 - 10%	7	X	X	X	X

Notes:

1. It is the responsibility of the user to define minimum and/or maximum values for each parameter (pass/fail criteria). These values should be based on the nearest equivalent military specification, manufacturer specification, or the application, whichever is most stringent.
2. A minimum of three thermistors shall be measured.
3. Zero-power resistance shall be measured in a controlled uniform medium capable of maintaining an accuracy of $\pm 0.05^\circ\text{C}$ for beads (any mounting construction) and $\pm 0.05^\circ\text{C}$ for all other types. The resistance shall be measured using a wheatstone bridge (or equivalent), accuracy to $\pm 0.05\%$ or better, with time response less than the thermal time constant of the thermistor under test.
4. The specified reference temperature is usually ambient $+25^\circ\text{C}$. However, since the resistance curve tolerance varies on either side of this reference ambient, for particular applications, it may be advantageous to specify the reference temperature at some other point, up to and including the temperature extremes. If a temperature extreme is used as the reference temperature, the complementary temperature for zero-power resistance and resistance ratio shall be the midpoint temperature between the temperature extremes. If the high temperature extreme is $< +125^\circ\text{C}$, this temperature shall be used for thermal shock and high temperature storage testing.

Table 14 Thermistor Screening Requirements (Page 3 of 3)

Notes (Continued):

5. Never expose a thermistor to an ambient temperature greater than its maximum operating temperature during testing under no load conditions. Such exposure, even for brief periods, can permanently destabilize the thermistor if the Curie temperature is exceeded. The maximum operating temperature, which can be determined from the power rating, is the maximum body temperature at which the thermistor will continue to operate with acceptable stability of its characteristics. The temperature at which the power has been linearly derated to 0% corresponds to the maximum ambient temperature under no load conditions.
6. External visual examination required after testing to verify no evidence of mechanical damage.
7. Marking defects shall not be counted for purposes of establishing the failure rate.

Table 15 Transformer Screening Requirements (Page 1 of 2)

Inspection/Test	Part Types	Test Methods and Conditions	Grade 1	Grade 2
Thermal Shock 25 cycles 10 cycles	All	Continually monitor during final cycle to verify no intermittent conditions. Monitoring current shall be ≤ 3 microamps. Open exceeding 100 microseconds shall be detectable. (Note 1)	X	X
Burn-In Power, No Load Power, with maximum rated load	< 0.8 Watts Output > 0.8 Watts Output	Duration at maximum rated temperature, rated input voltage, and current at minimum rated frequency.	96 hrs.	96 hrs.
Seal	If applicable, Grade 4 of MIL-T-27	MIL-STD-202, Method 112, and MIL-T-27, Paragraph 4.8.7	X	X
Dielectric Withstanding Voltage		MIL-STD-202, Method 301 and Method 105. Shall be measured at atmospheric pressure and at altitude in accordance with MIL-T-27, paragraph 4.8.8	X	X
Induced Voltage	Transformers with greater than 25 volts RMS for any winding	2 times rated voltage in accordance with MIL-T-27, paragraph 4.8.9. Inspect for evidence of arcing, insulation breakdown, abrupt input current changes.	X	X
Insulation Resistance	All	MIL-STD-202, Method 303 and MIL-T-27, paragraph 4.8.10	X	X

See notes on page C-41.

Table 15 Transformer Screening Requirements (Page 2 of 2)

Inspection/Test	Part Types	Test Methods and Conditions	Grade 1	Grade 2
Electric characteristics No Load Rated Load DC Resistance and Resistive Unbalance Harmonic Distortion Frequency Response Insertion Loss Self-Resonant Frequency Electrostatic Shielding Magnetic shielding Polarity Storage Factor (Q) Wave Shape Turns Ratio Phase Shift	As Applicable	As specified and in accordance with MIL-T-27, paragraph 4.8.11	X	X
Radiograph Inspection	All	MIL-STD-981, Appendix C	X	
Visual and Mechanical Examination	All	MIL-T-27, Paragraph 4.8.1	X	X

Notes:

1. For Grade 1 parts with magnet wire small than 30 AWG, measure DC resistance before and after each cycle.

Table 16 Wire and Cable Screening Requirements (Note 1) (Page 1 of 3)

Inspection/ Test	Test Methods Conditions and Requirements	Wire or Cable Type/Grade Level							
		Insulated		Magnet		Coaxial		Multiconductor	
		1	2	1	2	1	2	1	2
Visual	Inspect for proper marking, insulation, and color. Check workmanship for insulation cracks, splits. For magnet wire only, check for blisters or runs. Use 3x magnification and high intensity lighting.	X	X	X	X	X	X	X	X
Mechanical (Note 2)	Verify finished wire or cable diameter per reference specification. Verify proper number of wire strands and AWG of strands in conductor(s) and shield (if applicable). Verify weight as necessary. Inspect for discoloration or corrosion of the strands. Wire plating finish or coating shall not flake off from normal flexing.	X	X	X	X	X	X	X	X
Impulse Dielectric Test (Insulation/Jacket flaws Test) Not Applicable to copper-clad Semi-Rigid Cable (Note 3)	FED-STD-228 Method 6211.1 or MIL-STD-2223 method 3002. Finished wire or cable shall be passed through a bead chain electrode head which will give intimate metallic contact with the wire insulation surface or cable jacket. Voltage potential as specified in detail specification shall be applied between the electrode and wire conductor or cable shield. Wire lengths with failed insulation shall be removed.	X	X			X	X	X	X
Wrap Test (Extruded Insulations) (Note 4)	MIL-W-22759, paragraph 4.6.3.3. Sample shall be baked for 2 hours at the temperature specified in the detail specification. After cooling, the sample shall be examined for cracked insulation.	X	X						
Lamination Sealing Test (Tape Sintered Insulations)	MIL-W-81381, paragraph 4.7.4.10. Sample shall be baked at the temperature specified in the detail specification for 48 hours. After cooling, visually examine for delamination of the insulation.	X	X						

See notes on page C-44.

Table 16 Wire and Cable Screening Requirements (Note 1) (Page 2 of 3)

Inspection/ Test	Test Methods Conditions and Requirements	Wire or Cable Type/Grade Level							
		Insulated		Magnet		Coaxial		Multiconductor	
		1	2	1	2	1	2	1	2
DC Resistance	FED-STD-228, Method 6021. Measurements shall conform to MIL-W-22759, Table II. Wire shall be tested dry without immersion.	X	X						
Adherence and Flexibility (Note 5)	a. Clamp 10 inches apart, elongate as specified and examine for insulation separation from the wire as specified. (Note 6) b. Wind around mandrel and examine for cracks or separation as specified. (Note 6)			X	X				
Heat Shock (Note 5)	Bake at maximum rated temperature for 30 minutes. Examine for cracks at specified magnification. (Note 6)			X	X				
Dielectric Withstanding Voltage (Note 7)	FED-STD-228, Method 6111, except cable shall be tested dry without immersion. For coaxial cable, apply voltage (potential as specified) between inner conductor and shield with the shield grounded. For multiconductor cable, each conductor shall be tested against all others tied to the shield.			X (Note 8)	X (Note 8)	X	X	X	X
Continuity (Note 7)	Apply 25 V DC max to both ends of conductor(s), followed by both ends of shield through an indicator (meter, light, or buzzer).					X	X	X	X

See notes on page C-44.

Table 16 Wire and Cable Screening Requirements (Page 3 of 3)

Notes:

1. Visual and mechanical inspection, wrap test, lamination sealing test, adherence and flexibility, and heat shock shall be performed on a 1 foot sample per spool. Impulse dielectric test shall be performed on entire length of wire or cable. DC resistance, dielectric withstanding voltage and continuity test shall be performed on each spool. For commercial multiconductor cable, individual wires shall have been tested in accordance with insulated wire requirements specified herein prior to application of shield or jacket.
2. A certificate of compliance from the manufacturer shall be required to certify that the proper conductor material and finish were used in the manufacture of the wire.
3. Test is used as a 100% screening test of finished wire during final winding of the wire on spools or reels by the manufacturer. Military QPL wire and cable already meet this requirement. For non-QPL wire, a certificate of compliance from the manufacturer, stating that all wire delivered to the user passed the impulse dielectric test, is sufficient to meet this requirement. Otherwise, wire shall be screened by the user. The MIL-STD-2223 high frequency spark test (Method 3008) is an acceptable alternative to the impulse dielectric test.
4. Test is used to determine if wire insulation is over sintered resulting in degraded properties. For Teflon insulated wire, Differential Scanning Calorimetry (DSC) per ASTM-E794 may also be performed to determine if wire is undersintered from incomplete processing. Either condition can lead to cracked insulation during use.
5. Required for non-military, non-NEMA magnet wire only. A certificate of compliance shall be required for military, NEMA wire. Heat shock test must follow adherence and flexibility test.

6. **Examination and Elongation Requirements for Copper Magnet Wire**

AWG Size	Elongation Rate	Minimum Elongation	Mandrel Diameter	Examined With
4-9	12 ± 1 in/min (300 ± 25 mm/min)	30%	none	3X - 10X magnification
10-13	12 ± 1 in/min (300 ± 25 mm/min)	25%	5X	6X - 20X magnification
14-30	12 ± 1 in/min (300 ± 25 mm/min)	20%	3X	10X - 30X magnification
31-44	12 ± 1 in/min (300 ± 25 mm/min)	20% or breakage	3X or 0.0156 (1/64 inch drill bit), whichever is greater	30X - 70X magnification

7. Test is used as a 100% screening test of finished cable on spools or reels by the manufacturer. MIL-C-17 QPL coaxial cable and MIL-C-27500 multiconductor cable already meet this requirement. For non-QPL cable, a certificate of compliance from the manufacturer, stating that all cable delivered to the user passed the dielectric withstanding voltage and continuity tests, is sufficient to meet requirements. Otherwise, cable shall be screened by the user.
8. For non-military, non-NEMA specified magnet wire the Dielectric Strength test of NEMA specification, MW 1000, Part 3, paragraph 3.8, or the Dielectric Breakdown Voltage test of ASTM Standard D1676, paragraphs 69 and 74, shall be performed.

**Table 17 Crystal Oscillator Screening Requirements (Page 1 of 2)
Discrete Component Construction**

Inspection/Test	Test Methods and Conditions (Note 1)	Grade 1	Grade 2
1. Internal Visual Inspection a. Soldering (Note 2) b. Workmanship	MIL-S-45743 MIL-O-55310, paragraph 3.9	X	X
2. Random Vibration	MIL-STD-202, Method 214, Condition I-B, 5 minutes per axis	X	
3. Thermal Shock	MIL-STD-202, Method 107, Condition A-1	X	X
4. Pre Burn-In Electrical Input Current - Power Output Waveform Output Voltage	Measure oscillators input current or calculate power from measured voltage and current. Measure oven input current or calculate power for types 4 and 6. For type 8 oscillators determine syntonization energy, $Q=E \int_0^t I(t)dt$, from measured value of current. Approximate with the Trapezoidal Rule for n=10 equally spaced intervals. Verify the type of output waveform. Measure output voltage and measure or calculate output power. For VCOs, turn off the modulation-control input voltage and specify the dc input reference level. For square wave output waveforms, output logic levels shall be measured across a specified load. (Note 3)	X	X
5. Burn-In (Load)	Max. operating temperature. Nominal supply voltage and load as specified.	240 Hours	160 Hours
6. Post Burn-In Electrical	Repeat step 4 above	X	X
7. Frequency Aging	70°C (room temperature for oven controlled oscillators). Stabilize 1 hour (48 hours for types 3 and 8). Measure initial frequency after stabilization and at intervals not to exceed 72 hours (20 hours for types 3 thru 8 with 4 measurements per week). Change between initial and any subsequent frequency shall not exceed specified value. See MIL-O-55310.	30 days	
8. PDA (Note 4)		5%	10%

See notes on page C-46.

**Table 17 Crystal Oscillator Screening Requirements (Page 2 of 2)
Discrete Component Construction**

Inspection/Test	Test Methods and Conditions (Note 1)	Grade 1	Grade 2
9. Radiographic Inspection	MIL-STD-202, Method 209, 1 View 1 in Y1 Direction, 2nd View 90° Relative to 1st View	X	X
10. Additional Electrical Measurements	Table 17B	X	
11. Seal Test	MIL-STD-202, Method 112 and MIL-O-55310, Paragraph 4.9.2	X	X

Notes:

1. It is the responsibility of the user to specify detail test conditions and define pass/fail criteria for each test. These values shall be based on the nearest equivalent military specifications, the manufacturer's specification, or the application, whichever is most severe. MIL-O-55310 is the reference specification.
2. Certification of soldering personnel is required.
3. Test loads for TTL and CMOS compatible oscillators shall be as shown in Figure 7 of MIL-O-55310 unless otherwise specified.
4. Percent Defective Allowable (PDA) calculations shall include both burn-in and frequency aging failures for Grade 1 parts.

**Table 17A Crystal Oscillator Screening Requirements (Page 1 of 2)
Hybrid Microcircuit Construction**

Inspection/Test	MIL-STD-883 Test Methods and Condition (Note 1)		Grade 1	Grade 2
	Method	Conditions		
1. Non Destructive Bond Pull	2023		X	
2. Internal Visual	2017	C, 150°C,	X	X
3. Stabilization Bake (Prior to Seal)	1008	Duration (Hours)	X 48	X 24
4. Thermal Shock	1011	A	X	
5. Temperature Cycling	1010		X	X
6. Constant Acceleration	2001	A, Y ₁ only, 5000G's	X	X
7. PIND	2020	B	X	X
8. Pre Burn-In Electrical			X	X
Input Current - Power		Measure oscillators input current or calculate power from measured voltage and current. Measure oven input current or calculate power for types 4 and 6. For type 8 oscillators determine syntonization energy, $Q = E \int_0^t I(t)dt$, from measured value of current. Approximate with the Trapezoidal Rule for n=10 equally spaced intervals.		
Output Waveform		Verify the type of output waveform.		
Output Voltage		Measure output voltage and measure or calculate output power. For VCOs, turn off the modulation-control input voltage and specify the dc input reference level. For square wave output waveforms, output logic levels shall be measure across a specified load. (Note 2)		
9. 9. Burn-In (Load)		125°C, Nominal Supply Voltage and Burn-In Loads	240 Hours	160 Hours
10. Post Burn-In Electrical		Repeat Step 8 Above	X	X

See notes on page C-48.

**Table 17A Crystal Oscillator Screening Requirements (Page 2 of 2)
Hybrid Microcircuit Construction**

Inspection/Test	MIL-STD-883 Test Methods and Conditions (Note 1)		Grade 1	Grade 2
	Method	Conditions		
11. Frequency Aging	70°C (room temperature for oven controlled oscillators). Stabilize 1 hour (48 hours for types 3 and 8). Measure initial frequency after stabilization and at intervals not to exceed 72 hours (20 hours for types 3 thru 8 with 4 measurements per week). Change between initial and any subsequent frequency shall not exceed specified value. See MIL-O-55310.		30 days	
12. PDA (Note 3)			5%	10%
13. Additional Electrical Measurements	Table 17B		X	
14. Radiographic Inspection	2012		X	X
15. Seal Test	1014		X	X
a. Fine Leak		A or B		
b. Gross Leak		C		

Notes:

1. It is the responsibility of the user to specify detail test conditions and define pass/fail criteria for each test. These values shall be based on the nearest equivalent military specifications, the manufacturer's specification, or the application, whichever is most severe. MIL-O-55310 is the reference specification.
2. Test loads for TTL and CMOS compatible oscillators shall be as shown in Figure 7 of MIL-O-55310 unless otherwise specified.
3. Percent Defective Allowable (PDA) calculations shall include both burn-in and frequency aging failures for Grade 1 parts.

Table 17B Additional Electrical Measurements (Page 1 of 2)

Test	Test Methods, Conditions and Requirements (Note 1)	Type (Note 2)
1. Oscillator Supply Voltage	Measure voltage magnitude, tolerance, polarity, regulation, peak to peak ripple, ripple frequency and noise across oscillator input terminals with specified load.	All
2. Modulation - Control Input Voltage	Same as 1 above, but also measure modulation magnitude and dc level limits or dc control magnitude	2, 5, 6
3. Oven Supply Voltage	Same as 1 above, but measure oven voltage etc. across input terminals of oven.	4, 6
4. Overvoltage Survivability	Apply overvoltage 20% above maximum specified supply voltage for 1 minute, with no performance degradation. Do not exceed 16.5 volts for oscillators employing CMOS parts.	All
5. Frequency Adjustment	Stabilize at reference temperature and determine by frequency measurements that output signal can be set to either nominal frequency, or marked frequency offset, with specified resolution, and adjusted oven specified range.	Adjustable
6. Initial Frequency - Temperature Accuracy	Stabilize at lowest specified temperature and measure frequency. Increase temperature in specified steps (allowing stabilization), and record frequency until highest specified temperature is reached. Calculate frequency-temperature accuracy in accordance with paragraph 4.9.10.1.	All
7. Frequency-Voltage Tolerance	Set oscillator supply voltage (oven supply voltage, if applicable) to nominal, minimum, and maximum values and measure output frequency. Determine frequency-voltage tolerance in accordance with paragraph 4.9.14.	All
8. Rise and Fall Times	Measure between specified voltage levels. For TTL and CMOS compatible oscillators, the lower measurement level shall be 0.8 volts and 10% of signal level respectively. The upper measurement level shall be 2.0 volts and 90% of signal level respectively.	Square Wave
9. Duty Cycle	Measure at 50% voltage level, referenced to ground, and express as percent of wave form period. The measurement level for TTL and CMOS compatible oscillators shall be 1.4 volts and 50% V _{DD} respectively.	Square Wave
10. Modulation-Control Input Impedance	Apply modulation-control input voltage to input terminals through series resistance. Measure voltage across series resistor and input terminals and calculate input impedance in accordance with paragraph 4.9.29.	2, 5, 6
11. Frequency Deviation	Assemble test equipment in accordance with Figure 13 of MIL-O-55310, and measure (calculate) total deviation, deviation slope polarity, and deviation linearity in accordance with paragraph 4.9.30.	2, 5, 6

See notes on page C-50.

Table 17B Additional Electrical Measurements (Page 2 of 2)

Notes:

1. It is the responsibility of the user to specify detail test conditions and define pass/fail criteria for each test. These values shall be based on the nearest equivalent military specifications, the manufacturer's specification, or the application, whichever is most severe. MIL-O-55310 is the reference specification.

2. TYPES
 - Type 1 - Crystal Oscillators (XO)
 - Type 2 - Voltage Controller Crystal Oscillators (VCXO)
 - Type 3 - Temperature Compensated Crystal Oscillators (TCXO)
 - Type 4 - Oven Control Crystal Oscillators (OXCO)
 - Type 5 - Temperature Compensated-Voltage Controlled Crystal Oscillators (TCVCXO)
 - Type 6 - Oven Controlled Voltage Controlled Crystal Oscillators (OCVCXO)
 - Type 7 - Microcomputer Compensated Crystal Oscillators (MCXO)
 - Type 8 - Rubidium - Crystal Oscillators (RUXO)

Section 51 Recommended Screening Guidelines for Optoelectronic Parts

Table 51-01 Screening Guidelines for Detectors and Emitters

Inspection/Test	Methods	MIL-STD-750		
		Conditions and Requirements	Grade 1	Grade 2
1. Internal Visual	2073		X	X (Note 1)
2. Temperature Cycling	1051	Condition G (-55 °C to +150 °C) or max storage temperature whichever is less No dwell is required at 25°C. 20 cycles, t (extreme) ≥ 10 min.	X	X
3. Constant Acceleration	2006	20,000 g's in Y ₁	X	X
4. PIND	2052	Condition A. Not required for non-cavity devices.	X	X
5. Serialization			X	
6. Initial Electrical and Optical Measurements		Read and record delta parameters per Table 51-01A on next page	X	X
7. Burn-In	1038	Per Table 51-01A. Duration (Hours)	X 240	X 160
8. Final Electrical		See Table 51-01A	X	X
9. Calculate Deltas		See Table 51-01A	X	
10. Percent Defective Allowable		PDA applies to the combined delta calculations and DC measurements @ 25°C.	5%	10%
11. Hermetic Seal a. Fine Leak b. Gross Leak	1071	G or H. C or K	X	X
12. Radiographic	2076		X	
13. External Visual	2071		X	X

Note:

1. DPA may be performed on 5 samples to S-311-M-70 in lieu of internal visual for sealed devices.

Table 51-01A Burn-In Conditions and Electrical and Optical Parameters for Detectors and Emitters

Device Type	Burn-In per MIL-STD-750, Method 1038	Initial/Final Electrical Measurements (Notes 1, 2, 3)	Delta Parameters and Limits
Detector (Pin or Avalanche Diode)	Condition A, 80% V_R (Max rated), @ 80% Max Operating Temperature	$R, C, V_{BR}, I_D,$ $t_r, t_f,$ Responsivity Linearity	$R \leq 25\%$ $I_D \leq 0.5nA$ or 100%, whichever is less
Emitter	Condition B, I_F (Max rated), @ $T_J = 100^\circ C$	$V_F, P_T, t_r, t_f, \lambda\rho$ $\Delta\lambda, V_{(BR)R},$ Frequency Response	$V_F \leq 25\%$ $P_T \leq 20\%$

Notes:

1. See MIL-D-24620 and MIL-S-24622 for symbol definitions, test methods, and typical test conditions.
2. Minimum required parameters are specified. Other device or application critical parameters shall also be measured
3. Parameters which represent optical performance shall be measured at 25°C. All other parameters shall be measured at 25°C and at the minimum and maximum rated operating temperatures.

Table 51-02 Screening Guidelines for Transmitters and Receivers

The screening requirements for Hybrid Electronic Devices, given in Table 10B, are applicable for fiber optic transmitters, receivers and transceivers. In addition to the requirements for hybrid devices, these parts should be subjected to additional connection tests if they are supplied with optical cable pigtails.

Table 51-02A Electrical and Optical Parameter Measurements for Optical Transmitters and Receivers (Note 1)

Measurement	Test Method	Part Type			
		Transmitters		Receivers	
		Analog	Digital	Analog	Digital
Output Short Circuit Protection	MIL-STD-883, Method 3011	X	X	X	X
Power Supply Voltage and Current	MIL-STD-883, Method 3005	X	X	X	X
Pulse Width Distortion and Delay (Note 1)	MIL-R-24720, Para. 4.6.4.4		X		X
Jitter	MIL-R-24720, Para. 4.6.4.5				X
Optical Power Spectrum (Note 2)	MIL-T-24721, Para. 4.6.4.2	X	X		
Optical Power Levels (Note 2)	MIL-T-24721, Para. 4.6.4.3	X	X		
Spectral Responsivity	MIL-R-24737, Para. 4.6.3.2.1			X	
Signal to Noise Ratio	MIL-R-24737, Para. 4.6.3.3.1	X		X	
Frequency Range	MIL-R-24737, Para. 4.6.3.3.2	X		X	
Amplitude Modulation Distortion	MIL-R-24737, Para. 4.6.3.3.5	X		X	
Group Delay	MIL-T-24735, Para. 4.6.3.3.6	X			

Notes:

1. For Transmitters, use MIL-T-24721, Paragraph. 4.6.4.4, 4.6.4.5 and MIL-STD-883, Method 3004
2. The extinction ratio measurement is not required. For Analog transmitters, a suitable analog input signal shall be used.

Table 51-03 Screening Guidelines for Optical Connectors (Note 1)

Test/Inspection	Test Method	Conditions
	MIL-STD-1344	
Visual and Mechanical		See Table 51-03A
Contact Engage and Separate Force (removable contacts only)	2014	Use standard mating termini or applicable alignment sleeve. Measure axial force for compliance with part ratings.
Hermeticity (if applicable)	1008	

Notes:

1. Including optical termini.

Table 51-03A Visual and Mechanical Inspections for Optical Connectors

<p style="text-align: center;"> DIMENSIONS WEIGHT KEYING MARKING (SHELL and INSERT) WORKMANSHIP PLATING QUALITY FERRULE QUALITY FERRULE HOLE CIRCULARITY AND CONCENTRICITY INSERT QUALITY AND ORIENTATION CONSTRUCTION AND ASSEMBLY </p>
--

Table 51-04 Screening Guidelines for Optical Cable

Test/Inspection	Test Method	Conditions
	EIA/TIA-455	
Visual and Mechanical		See Table 51-04A
Attenuation Rate	46	

Table 51-04A Visual and Mechanical Inspections for Optical Cable

<p>QUALITY AND WORKMANSHIP OF EACH CABLE COMPONENT</p> <p>EVEN DISTRIBUTION OF STRENGTH MEMBERS</p> <p>DIAMETERS</p> <p>MARKING</p> <p>FIBER COATING ADHESION</p> <p>FIBER CIRCULARITY AND CONCENTRICITY</p> <p>CABLE WEIGHT</p>
--

THIS PAGE INTENTIONALLY LEFT BLANK

APPENDIX D

RADIATION EFFECTS

INTRODUCTION

The space radiation environment poses a risk to all earth orbiting satellites and missions to other planets. Charged particles in this environment consist primarily of high energy electrons, protons, alpha particles and heavy ions (cosmic rays). The radiation effects of these charged particles are dominated by ionization (generation of electron-hole pairs) in electronic devices and materials. Energy deposited in a material by ionizing radiation is expressed in "rads", with one rad equal to 100 ergs/gram (material specified). The energy loss per unit mass differs from one material to another because of the atomic differences in various materials. For semiconductor devices, the units of absorbed dose are rads(Si).

Radiation Effects

There are two types of radiation damage induced by charged particle ionization in the natural space environment. These are total dose effects and Single Event Effects (SEE). The total dose effects are cumulative ionization damage caused by the charged particles passing through a semiconductor device. For MOS devices, this ionization traps positive charges in the gate oxide and produces interface states in silicon at the silicon-silicon dioxide interfaces. These effects cause threshold voltage shifts and decrease channel carrier mobility, resulting in increased leakage current, power supply current, and possible loss of device functionality. For bipolar devices, ionization adversely affects current gain and junction leakage currents, causing significant degradation in device performance. This performance degradation can lead to increased offset voltage and input bias current in op amps, and loss of accuracy and functionality in analog-to-digital converters (ADCs) or digital-to-analog converters (DACs).

Single Event Effects (SEE) are caused by a high energy single ion (heavy ion or energetic proton) passing through a device. SEE include Single Event Upsets (SEU), Single Event Latchup (SEL), Single Event Snapback, Single Event-Induced Burnout (SEB) and Single Event Gate Rupture (SEGR). While SEU are non-destructive, and do not cause permanent damage to the device, the other single event effects can be destructive under certain conditions. A brief description of these effects is provided below:

1. SEU or soft errors occur due to either the deposition or depletion of charge by a single ion at a circuit node, causing a change of state in the memory cell (bit upset). In very sensitive devices, a single ion hit can also cause multiple-bit upsets (MBUs) in adjacent memory cells. However, these SEUs and MBUs cause no permanent damage and the device can be reprogrammed for correct functioning.

2. SEL can occur in any semiconductor device which has a parasitic n-p-n-p path. A single heavy ion or high energy proton passing through either the base emitter junction of the parasitic n-p-n transistor, or the emitter-base junction of the p-n-p transistor can initiate regenerative action. This leads to excessive power supply current and loss of device functionality. Device burnout may also occur unless the current is limited or the power to the device is reset. SEL is of most concern in bulk CMOS devices.
3. Single Event Snapback, like SEL, is also a regenerative current mechanism, but does not require a n-p-n-p structure. It can be triggered in n-channel MOS transistors with large currents, such as IC output driver devices, by a single event hit-induced avalanche multiplication near the drain junction of the device.
4. SEB may occur in power MOSFETs when the passage of a single heavy ion forward-biases the thin body region under the source. If the drain-to-source voltage (V_{DS}) of the device exceeds the local breakdown voltage of the parasitic bipolar, the device can burn out due to large currents and high local power dissipation. If V_{DS} is appropriately derated, it is possible to avoid SEB in power MOSFETs.
5. SEGR has been observed due to heavy ion hits in power MOSFETs when a large bias is applied to the gate, leading to thermal breakdown and destruction of the gate oxide. It can also occur in nonvolatile memories such as EEPROMs during write or erase operations, when high voltage is applied to the gate.

A radiation risk assessment for any electronic device includes the determination of total dose damage and SEE susceptibility of the device caused by the projected radiation environment of the spacecraft. Most total dose damage is caused by high energy protons and electrons and by secondary radiation, such as bremsstrahlung. The major contributors to SEE are heavy ions. The very high fluences of high-energy protons seen during heavy solar flares and during the excursion of the satellite through the South Atlantic Anomaly (SAA) can also contribute significantly to SEE.

It should be noted that, while the total dose radiation on a device can vary significantly with the amount of shielding interposed between the device and the outside environment, the heavy ion and high-energy proton fluences (and hence the SEE susceptibility) do not change significantly with shielding.

EVALUATION OF TOTAL DOSE SENSITIVITY OF PARTS

Total dose testing is generally performed by exposing devices to gamma rays from a Cobalt-60 source (MIL-STD-883, Method 1019 for Total Dose Test Procedure). The dose rates in the natural space radiation environment are very low (0.0001 - 0.01 rads(Si)/sec). It is not feasible to simulate the low dose rate space environment during ground testing, because excessive times would be required to complete the tests. Ground test dose rates usually vary from 0.01 - 300 rads(Si)/sec. For space applications, the recommended dose rates should be kept as low as possible, preferably 0.01 - 2 rads(Si)/sec. The dose rates used depend on the predicted device

radiation sensitivity and the projected mission total dose. Some device types and technologies show more variation of radiation sensitivity with dose rate than others. Most device types and technologies show higher total dose tolerance at low dose rates; however, some device types and technologies have shown increased degradation at low dose rate testing.

Available total dose test data have shown that passive devices, e.g., resistors and capacitors, show no significant degradation up to 1000 krads. Discrete semiconductor devices, such as diodes, are not significantly affected by radiation; only small changes in reverse leakage current are observed for total doses up to 100 krads. Most discrete bipolar transistors, e.g., 2N2222A, 2N2219 and 2N2484, are not significantly affected when they are operated at high currents. However, in low current operation, gain degrades significantly after 20 to 100 krads irradiation. The radiation threshold at which these gain degradations become significant varies with transistor type and with collector current. However, high-power MOSFETs (such as 2N6786, 2N6788, etc.) can be very sensitive to total dose; electrical parametric degradation may occur at 2 to 5 krads and devices may fail catastrophically between 20 and 50 krads.

For microcircuits, the total dose tolerance varies over a wide range, from less than 1 krad to more than 1000 krads, depending on the device's technology and manufacturing process. While bipolar digital ICs are relatively hard (resistant) to total dose effects, digital ICs with MOS or mixed BiMOS technologies can be quite susceptible to total dose. Analog devices using MOS and BiMOS technologies have shown significant degradation in the range of 2 - 20 krads. Furthermore, recent test data have shown that bipolar linear devices, such as op amps and comparators, when tested at low dose rates (0.001 - 10 rads(Si)/sec), show significant degradation in the range of 5-50 krads. In earlier work, when testing was done at higher dose rates, bipolar linear devices were found to be radiation-tolerant to exposures ranging from 50 to 100 krads.

Microcircuit radiation hardness varies not only with the device type and technology, but also with subtle process variations within a manufacturing line over different wafer lots. Radiation test results strongly depend on test details, such as the nature of the irradiating source, bias condition and dose rates. All these factors make it difficult to specify a hardness level for a particular technology and part type. When using non-radiation-hard devices, it is recommended that samples from flight lots be tested for radiation tolerance.

Another device category which may be affected significantly by radiation is optoelectronic devices, such as those used in fiber optics communication systems. These systems include optical fibers, light sources (emitters), light detectors, connectors and couplers. A number of emitters, detectors, connectors and couplers are not adversely affected by ionizing radiation up to 100 krads; however, non-radiation hardened optical fibers may exhibit attenuations several times greater than their intrinsic losses during low level (a few krads) total dose irradiation. Radiation induced losses in fibers vary significantly with fiber composition and with total dose magnitude and rate, wavelength of measurement, ambient temperature, time after exposure, length of fiber exposed and light injection conditions.

EVALUATION OF SEE SENSITIVITY OF PARTS

Evaluation of SEE sensitivity varies with the device type. For example, for a digital device, such as a shift register or memory, it includes evaluation of SEU and SEL sensitivity. For bipolar analog devices, such as op amps, ADCs and DACs, the same two effects are evaluated; however, SEL is of more significant concern. For power MOSFETs, SEGR and SEB are more significant degradation and failure mechanisms.

SEE rates for predicted space radiation environments are estimated using heavy ion and proton test data taken at an accelerator or a cyclotron facility. These data include the Linear Energy Transfer (LET) threshold and the device error cross section. To predict upset rates, the LET spectra for each mission are determined using orbital parameters, shielding estimates and the appropriate solar activity levels. The LET spectra, LET threshold and device error cross section are analytically modeled to calculate the upset rate. The error rate calculations involve complex computations and several approximations regarding device geometry, sensitive volume and uncertainties in the heavy ion and high energy proton fluence. Two frequently used analytical models for upset rate calculation are CREME (Cosmic Ray Effects on Microelectronics) and Integral Error Rate Prediction Technique.

In order to assure system hardness, each project should perform an application analysis for all of its electronic parts which may be susceptible to SEE. The analysis should account not only for the number of SEE occurrences anticipated during the mission-lifetime, but also for the worst-case SEE rates resulting from transient peaks in the radiation environment, such as high proton fluences from solar flares and the SAA. This analysis is performed based on available SEE data, but may often require specific testing of parts for evaluation of their SEE sensitivity. To mitigate the effect of SEE in sensitive parts, hardware and software techniques such as error detection and correction, redundancy and fault tolerance schemes, and current limiting resistors in power supply circuits can be used.

SELECTION OF RADIATION-HARD PARTS

In recent years, a number of vendors have qualified some of their part technologies to the following standard total dose radiation levels: 3 K, 10 K, 50 K, 100 K, 300 K, 600 K and 1 M rad. Parts qualified to these levels are identified in MIL-I-38535 and MIL-S-19500 by the symbols M, D, L, R, F, G and H respectively, substituted as a replacement symbol for the slash mark (denoting non-radiation-hardened) in the part markings. Most of these radiation-hard parts are digital part types; very few linear part types are available as rad-hard.

Parts which are hardened to various total-dose radiation levels are not necessarily less sensitive to SEE. For radiation-hardening to SEE, some manufacturers are using cross-coupled resistors in memory cells to achieve SEU hardness for space applications. Also, some manufacturers are fabricating parts using Silicon-On-Insulator (SOI) technology, which guarantees SEL hardness.

While designing systems for space applications, use of available radiation hardened parts is recommended. However, cost and performance requirements and schedule constraints can often

restrict the use of available radiation-hard parts and lead the designers to use non-radiation-hard parts. The use of parts in RAD-PAK™ which incorporates radiation shielding in the microcircuit package, can enable non-radiation-hardened chips to be used in a number of space applications. It should be noted that, while the RAD-PAK™ can improve the total dose radiation tolerance of the devices up to 100 krads, the device sensitivity to SEE is not reduced. The Parts Branch Radiation Specialist can provide additional guidance and information concerning the selection of parts suitable for mission-radiation requirements.

In evaluating the suitability of electronic devices in their intended application, it is of extreme importance to determine the radiation environment to which these parts will be subjected. The radiation environment varies significantly with orbital parameters and solar activity level. Also, the radiation environment experienced by a device inside the spacecraft is affected by the shielding provided by the spacecraft walls and other materials interposed between the device and the outside environment. Therefore, the radiation environment must be characterized for each project before assessing the total dose and SEE sensitivity of the devices selected for system design.

RADIATION TEST DATA

The JPL RADATA Data Bank provides a significant amount of SEE and total dose test information. This data bank is sponsored by the NASA Office of Safety, Reliability, Maintainability and Quality Assurance (Code Q) and is carried out by the JPL Electronic Parts Reliability Section 514. It is accessible via a user's personal computer using either a modem or internet. The procedure to access this data bank is provided below.

Procedure to Access JPL RADATA Bank

Via MODEM

BBS#: (818) 393-1725
Full Duplex (up to 14.4 Kbaud)
8 bits
1 stop
no parity

Via INTERNET

FTP: [radata.jpl.nasa.gov](ftp://radata.jpl.nasa.gov)
(137.79.11.2)
USERID: radata
PASSWORD: guest

For questions regarding RADATA BBS, please contact Keyvan Eslami at (818) 354-1715.

Test results from a number of radiation labs, manufacturers, etc., can also be found in "Proceedings of IEEE Annual Conference on Nuclear and Space radiation Effects", published from 1977 through 1994 in the December issue of IEEE Transaction on Nuclear Science, Vols. 24-41. Radiation characterization data may also be available from the part manufacturer. These data should be used only as guidelines, because the radiation response of the project flight parts can vary significantly from the reported test data.

Goddard Test Data

A significant amount of radiation testing has been performed recently on a variety of device types being used in Goddard projects. Table I lists parts which were tested for total dose radiation tolerance between January 1991 and the present. Testing was performed at low dose rates varying from 50 - 5,000 rads(Si)/hour (0.01 - ~1.4 rads(Si)/sec), depending on the project's total dose radiation requirements. Typical radiation test ranges were from 2.5-5 krad to 100-300 krad. Typical radiation test levels were 2.5, 5, 7.5, 10, 15, 20, 30, 50, 75, 100, 200 and 300 krad, depending upon the project's radiation environment and the predicted radiation tolerance of the parts. Most of the parts tested were not guaranteed by the manufacturer for radiation hardness. Some parts showed significant degradation at the first radiation level, while others passed throughout all irradiation and annealing steps. For information related to radiation-induced degradation or failure in the test level range, Lot Date Code of the parts tested and other details, refer to the report number cited in Table I.

Table II lists the parts that have been tested for SEE for GSFC projects from 1990 to the present. These tests were performed on microcircuits and optoelectronic devices, and included both Single Event Upset (SEU) and Single Event Latchup (SEL) tests. Testing was performed using high-energy protons and heavy ions at the following laboratories:

- i) Brookhaven National Laboratories (BNL)
- ii) Harvard University (HU)
- iii) Indiana University (IU)
- iv) University of California at Davis (UCD)

Qualified users may obtain a copy of Goddard radiation test data on any part type listed in Table I and Table II by submitting a request through their project office to the Office of Flight Assurance (OFA) Information Center. Please cite the PPM report number in your request.

Table I: Total Dose Radiation Testing for Goddard Projects (Page 1 of 8)

It should be noted that radiation results vary significantly with the Lot Date Code and any variation in the process technology by the manufacturer, as well as with details of the radiation testing, such as dose rate, bias conditions, electrical parameters and functional characteristics measured. The information in these reports is for general guidance only and is subject to change at any time.

S/N	Part Number	Part Type	Manufacturer	Project	Report
1	HS2-3530RH-Q	Op Amp	Harris	ISTP/CB	PPM-91-003
2	54HSC161CSO	4 bit counter	Marconi	ISTP/CB	PPM-91-008
3	HCS4538KMSR	Multivibrator	Harris	ISTP/CB	PPM-91-004
4	MAR7001CB2	512x9 FIFO	Marconi	ISTP/CB	PPM-91-039
5	HS5212B	12 bit ADC	Sipex	SMEX/CB	PPM-91-048
6	IDT7203L650DB	2kx9 FIFO	IDT	ISTP/NC	PPM-91-061
7	MR8251A/B	USART	Intel	SMEX/CB	PPM-91-053
8	HM1-6617-883	2kx8 PROM	Harris	ISTP/CB	PPM-91-065
9	82C59A	INTR Controller	Harris	SMEX/CB	PPM-91-075
10	AD96687TQ/883B	Dual Comparator	Analog Devices	ISTP/NC	PPM-91-097
11	PM-1012AZ/883	OP AMP	PMI	SMEX/CB	PPM-91-120
12	MC35181U	OP AMP	Motorola	ISTP/NC	PPM-91-109
13	JTXV1N759A-1	Zener Diode	BKC Intl	ISTP/NC	PPM-91-123
14	SI9110AK	Switch Cntrl	Siliconix	SMEX/CB	PPM-91-124
15	54AC08	2-Input NAND	NSC	SMEX/CB	PPM-91-136
16	JTXV1N3600	Diode	NSC	ISTP/NC	PPM-91-154
17	SQXO-2-100 KHz	Crystal Osc.	Statek	Hydra	rad-91-2
18	LP2951H/883	Adj. Volt Reg.	NSC	ISTP/NC	PPM-91-156
19	HA1-5320-8	S/H Amp	Harris	ISTP/NC	PPM-91-163
20	FRL130R3	N-MOSFET	Harris	SMEX/CB	PPM-91-168
21	54ACT245	Transceiver	NSC	SMEX/CB	PPM-91-191
22	SG1524B	PWM	Silicon Gen.	SMEX/CB	PPM-91-228
23	PALCE22V10H	PLA	AMD	Modis-T	rad-91-4
24	JTXV1N3595	Diode	NSC	ISTP/NC	PPM-91-246
25	54AC161	Counter	NSC	SMEX/CB	PPM-91-252
26	MC35184L	Quad OP AMP	Motorola	ISTP/NC	PPM-91-255
27	54AC138DMQB	DEMUX	NSC	SMEX/CB	PPM-91-267
28	LM160	Volt Comparator	NSC	ISTP/NC	PPM-91-268
29	HI1-506A	16-Analog MUX	Harris	TIROS/BASG	rad-91-6
30	JTXV2N6798	N-MOSFET	GE	Waves	rad-91-10
31	JTXV2N6849	P-MOSFET	IRC	Waves	rad-91-9
32	2N4117A-1	N-JFET	Siliconix	ISTP/NC	PPM-91-335
33	NCS4538KMSR	Multivibrator	Harris	ISTP-CB	PPM-91-337

Table I: Total Dose Radiation Testing for Goddard Projects (Page 2 of 8)

S/N	Part Number	Part Type	Manufacturer	Project	Report
34	OP43AJ/883	OP AMP	PMI	ISTP/NC	PPM-91-363
35	SQXO-2-200 KHz	Crystal Osc.	Statek	Hydra	rad-91-8
36	54AC04	Hex Inverter	NSC	SMEX/CB	PPM-91-376
37	ADC0808MJB	8 bit ADC	TI	ISTP/NC	PPM-91-330
38	OPA2107SM	OP AMP	Burr-Brown	ISTP/NC	PPM-91-375
39	MP5010NT	Volt Reference	Micro Power	ISTP/NC	PPM-91-383
40	MCM1609-21.86 KHz	Crystal Osc.	Q-Tech. Corp	ISTP/NC	PPM-91-382
41	CS7820-UD	8 bit ADC	Crystal Semi	ISTP/NC	PPM-91-384
42	AD571SD	10 bit ADC	Analog Devices	ISTP/NC	PPM-91-364
43	MC1350	OP AMP	Austin Semi	ISTP/NC	PPM-91-391
44	LM108A	OP AMP	Linear Tech	ISTP/NC	PPM-91-392
45	DIH-149	Sol St Relay	Dionics	GPEP	rad-91-12
46	SNJ54HC85	4 bit Compar	TI	ISTP/NC	PPM-91-412
47	AD7224UQ/883	8 bit DAC	Analog Devices	ISTP/NC	PPM-91-390
48	CA3127F	NPN Array	Harris	ISTP/NC	PPM-91-406
49	M54HC08YBF	AND Gate	SGS Thomson	ISTP/NC	PPM-91-407
50	CMP01	Comparator	PMI	ISTP/NC	PPM-91-393
51	JAN2N2608	JFET XSTR	Motorola	ISTP/NC	PPM-91-424
52	2N3946	NPN XSTR	Motorola	ISTP/NC	PPM-91-422
53	82C59A-5	INTR Cntrllr	Harris	ISTP/GEO	PPM-91-439
54	MT2815T/ES	DC/DC Conv	Interpoint	SMEX/CB	PPM-91-438
55	54AC245	8-Transceiver	NSC	SMEX/CB	PPM-91-442
56	54AC00	2-Input NAND	NSC	SMEX/CB	PPM-91-440
57	54AC86	OR Gate	NSC	SMEX/CB	PPM-91-441
58	54AC14	Hex Inverter	NSC	SMEX/CB	PPM-91-443
59	54AC109	JK Flip-Flop	NSC	SMEX/CB	PPM-91-437
60	54CA11	AND Gate	NSC	SMEX/CB	PPM-91-425
61	AD847	OP AMP	Analog Devices	ISTP/NC	PPM-91-394
62	AD549SH/883	OP AMP	Analog Devices	ISTP/NC	PPM-91-455
63	JTXV4N49	Opto-Coupler	TI	ISTP/NC	PPM-91-459
64	HA1-5134	Quad OP AMP	Harris	ISTP/NC	PPM-91-478
65	MC708-149	Crystal Osc	McCoy Elec	MODIS-T	PPM-91-483
66	LF111H-MIL	Volt Comparator	NSC	ISTP/NC	PPM-91-481
67	CA3080A	Transcon Amp	Harris	ISTP/NC	PPM-91-484
68	54ACO2DMQB	NOR Gate	NSC	SMEX/CB	PPM-91-508
69	TSC426MJA	MOSFET Driver	Teledyne	MODIS/T	PPM-91-509
70	HA7-5170-8	OP AMP	Harris	ISTP/CB	PPM-91-533
71	FRL913OR3	P-Power MOSFET	Harris	ISTP/WAVES	PPM-91-534

Table I: Total Dose Radiation Testing for Goddard Projects (Page 3 of 7)

S/N	Part Number	Part Type	Manufacturer	Project	Report
72	MN91204	12 Bit DAC	Micro Networks	SMEX/CB	PPM-91-522
73	IRHF7230	N-Power MOSFET	IRC	ISTP/WAVES	PPM-91-587
74	2299000-1, -2	1M Bit SRAMs	Teledyne	GPEP/PPL	PP<-91-587
75	DM28C256-300/B	EEPROM	SEEQ Tech.	ISTP/L3	PPM-91-610
76	UDS2983	Voltage Driver	Sprague Elec	SMEX/CB	PPM-91-551
77	54AC139DMQB	2 to 4 Decoder	NSC	SMEX/CB	PPM-91-628
78	SMJ320C30	32-Bit DSP	TI	ISTP/NC	PPM-91-612
79	54AC191	4 Bit Cntr	NSC	SMEX/CB	PPM-91-614
80	SMEX 5955-03/8	Crystal Osc.	Q-Tech Corp	SMEX/CB	PPM-91-645
81	54AC32	Quad 2-In. OR	NSC	SMEX/CB	PPM-91-645
82	TSC430MJA	MOSFET Driver	Teledyne	MODIS-T	PPM-91-637
83	2n5087	PNP Amp XSTR	Motorola	ISTP/NC	PPM-91-654
84	DPAD1-3	pA Dual Diodes	Interfet Corp	ISTP/NC	PPM-91-655
85	LF441	OP AMP	NSC	ISTP/NC	PPM-91-656
86	ZQO4031	32k x 8 SRAM	Elmo/Hitachi	GPEP/PPL	PPM-91-702
87	S128K8L-55MC	128k x 8 SRAM	Inova	GPEP/PPL	PPM-91-696
88	54ACT244LMQB	Octal Buffer	NSC	SMEX/CB	PPM-91-693
89	54AC20LMQB	4-Input NAND	NSC	SMEX/CB	PPM-91-692
90	OP232TX	LED	Optak Tech	ISTP-711	PPM-91-703
91	2N6453	N-JFET	Interfet	ISTP/NC	PPM-91-707
92	2298855-2	DC/DC Converter	Teledyne	SMEX/CB	PPM-91-709
93	54AC157DMQB	Quad 2-Inp MUX	NSC	SMEX/CB	PPM-91-706
94	54ACTQ373	Octal Latch	NSC	GPEP	PPM-91-713
95	54ACTQ08	2-Input AND	NSC	GPEP	PPM-91-712
96	54ACTQ374	Flip-Flop	NSC	GPEP	PPM-91-744
97	54AC74DMQB	D Flip-Flop	NSC	SMEX/CB	PPM-91-746
98	54ACT240	Octal Buffer	NSC	SMEX/CB	PPM-91-747
99	54AC151LMQB	8 Input MUX	NSC	SMEX/CB	PPM-91-755
100	U401-2	Dual N-JFET	Siliconix	ISTP/NC	PPM-91-757
101	JTXV2N3868	PNP XSTR	N. England Semi	SMEX/CB	PPM-91-759
102	54AC521DMQB	8 Bit Comp	NSC	SMEX/CB	PPM-91-754
103	54ACT74LMQB	Dual D Flip-Flop	NSC	SMEX/CB	PPM-91-760
104	AD7541ATQ	12-Bit DAC	Analog Devices	GPEP	PPM-91-710
105	54AC153LMQB	4-Input MUX	NSC	SMEX/CB	PPM-91-762
106	54ACT138LMQB	1 to 8 Decoder	NSC	SMEX/CB	PPM-92-010
107	AD574AT	12 Bit ADC	Analog Devices	GPEP	PPM-92-011
108	HA2620	OP AMP	Harris	GPEP	PPM-92-023
109	54ACT374LMQB	Octal Flip-Flop	NSC	SMEX/CB	PPM-92-003

Table I: Total Dose Radiation Testing for Goddard Projects (Page 4 of 8)

S/N	Part Number	Part Type	Manufacturer	Project	Report
110	AD524	Instr. Amp.	Analog Devices	GPEP	PPM-92-029
111	54ACT157DMQB	Quad 2-Inp. MUX	NSC	SMEX/CB	PPM-92-001
112	54AC374DMQB	Oct. Flip-Flop	NSC	SMEX/CB	PPM-92-004
113	54AC04DMQB	hex Inverter	NSC	SMEX/CB	PPM-92-009
114	2N5096	PNP Transistor	SSDI	ISTP/EPACT	PPM-92-036
115	2N5097	NPN Transistor	SSDI	ISTP/EPACT	PPM-92-037
116	54ACT373LMQB	Octal Latch	NSC	SMEX/CB	PPM-92-044
117	54AC373DMQB	Octal Latch	NSC	SMEX/CB	PPM-92-032
118	54AC244DMQB	Octal Buffer	NSC	SMEX/CB	PPM-92-039
119	54AC646LMQB	Octal Trans.	NSC	SMEX	PPM-92-054
120	AD544SH/883B	Op Amp	Analog Devices	ISTP/711	PPM-92-055
121	54AC20DMQB	4-Input NAND	NSC	SMEX	PPM-92-057
122	PA07M/883	Op Amp	Ampex	GGG	PPM-92-058
123	54AC299LMQB	Shift Register	NSC	SMEX	PPM-92-060
124	54AC540LMQB	Octal Buffer	NSC	SMEX	PPM-92-062
125	AD524	Instr. Amp	Analog Devices	SMEX	PPM-92-069
126	CD54HC74F3	D Flip-Flop	RCA	GGG/WIND	PPM-92-075
127	ICL766MJA/883B	Dual FET Driver	Harris	ISTP/PA	PPM-92-080
128	AD713TQ/883B	Op Amp	Analog Devices	ISTP/PA	PPM-92-079
129	AD829SQ/883B	Video Op Amp	Analog Devices	GGG/WIND	PPM-92-092
130	NC4011BM2RB	2-Input NAND	SGS Thomson	GGG/WIND	PPM-92-101
131	M54NC373YBF	Octal Latch	SGS Thomson	GGG/WIND	PPM-92-099
132	M54HC4020YBF	Binary Counter	SGS Thomson	GGG/WIND	PPM-92-094
133	JTXV2N6788	Power MOSFET	Siliconix	GGG/WIND	PPM-92-103
134	JM38510/11108	SPDT Switches	Intersil	EP/MMS/PA	PPM-92-110
135	CD54HC40103F3A	8-Bit Down Ctr.	RCA	GGG/WIND	PPM-92-115
136	CD54HC4053F3A	Mux/Dmux	RCA	GGG/WIND	PPM-92-116
137	JTXV4N49	Opto-Coupler	TI	CDS/CS2	PPM-92-114
138	HCC4053BM3RB	Mux/Dmux	SGS Thomson	GGG/WIND	PPM-92-122
139	AD674AT	12-Bit ADC	Analog Devices	POLAR-UVI	PPM-92-131
140	AD565ASH	12-Bit DAC	Analog Devices	ISTP/HYDRA	PPM-92-132
141	AG1562B	PWM	Silicon Gen.	CDS/CS2	PPM-92-152
142	AD744TQ/883B	Op Amp	Analog Devices	GGG/WIND	PPM-92-159
143	AD711TQ/883B	Op Amp	Analog Devices	GGG/WIND	PPM-92-160
144	AD712TQ/883B	Dual Op Amp	Analog Devices	GGG/WIND	PPM-92-163
145	MP7623TD/883B	D/A Conv	Micro Power	GGG/WIND	PPM-92-170
146	AD7541ATQ/883B	D/A Conv	Analog Devices	GGG/WIND	PPM-92-171
147	SNJ54HC4075J	OR-Gate	TI	GGG/WIND	PPM-92-177

Table I: Total Dose Radiation Testing for Goddard Projects (Page 5 of 8)

S/N	Part Number	Part Type	Manufacturer	Project	Report
148	M38510/14801BPA	Voltage Reg.	Motorola	CDS/CS2	PPM-92-181
149	DCA8408AT/883B	Quad 8-Bit DAC	Analog Devices	GGG/WIND	PPM-92-180
150	OP49DAY/883B	Quad Op Amp	PMI	GGG/WIND	PPM-92-185
151	AD7828UQ/883B	8-Bit ADC	Analog Devices	GGG/WIND	PPM-92-190
152	JTX2N5786	Power MOSFET	Harris	CDS/CS2	PPM-92-191
153	MIC4469AJB	Quad Driver	Micrel	CSEFW	PPM-92-202
154	M38510/11906BCA	Quad Op Amp	NSC	GGG/WIND	PPM-92-227
155	SNJ54HC4066J	Analog Switch	TI	GGG/WIND	PPM-92-237
156	M38510/75601BRA	Flip-Flop	NSC	FAST/MUE	PPM-92-244
157	MD82C59AB7011	Controller	Harris	TOMS/C4	PPM-92-251
158	M38510/75101BCA	2-Input NOR	NSC	FAST/MUE	PPM-92-253
159	M38510/76202BEA	4-Input MUX	NSC	FAST/MUE	PPM-92-270
160	54AC169DMQB	Counter	NSC	FAST/MUE	PPM-92-272
161	M38510/76302BEA	Binary Counter	NSC	FAST/MUE	PPM-92-279
162	5962-9098501MRA	Comparator	NSC	FAST/MUE	PPM-92-282
163	JANTXV2N2222A	NPN Transistor	Motorola	FAST/HCI	PPM-92-286
164	JANTXV4N24	Opto-Coupler	Micropac	FAST/HCI	PPM-92-299
165	2N5196	N-Channel JFET	Solitron	FAST/HCI	PPM-92-300
166	JTXV2N2219AL	NPN-Transistor	Motorola	GOES	PPM-92-301
167	JTXV2N2905AL	PNP-Transistor	Motorola	GOES	PPM-92-302
168	M38510/10201BCA	Regulator	Silicon Gen	FAST/HCI	PPM-92-305
169	M38510/10102BIC	Dual Op Amp	Raytheon	FAST/HCI	PPM-92-307
170	M38510/10104BGC	Op Amp	Linear Tech	FAST/HCI	PPM-92-308
171	JANTXV2N6782	N-Channel FET	IRC	HST	PPM-92-311
172	5962-87548023A	Comm Interface	Intel Corp	FAST/MUE	PPM-92-314
173	CD54AC112F3A	J-K Flip-Flop	Harris Corp.	FAST/MUE	PPM-92-315
174	M38510/11704BYA	Regulator	Linear Tech.	FAST/MUE	PPM-92-316
175	M38510/75705BRA	Buffer/Driver	National	FAST/MUE	PPM-92-317
176	54ACT534	Flip-Flop	National	FAST/MUE	PPM-93-004
177	OPA11VM/883B	Op Amp	Burr-Brown	FAST/MUE	PPM-93-031
178	OP 07A	Op Amp	PMI	FAST/MUE	PPM-93-033
179	REF 05 AJ/883C	Regulator	Analog Devices	FAST/MUE	PPM-93-035
180	54AC14	Inverter	National	FAST/MUE	PPM-93-036
181	OP43AJ/883	Op Amp	Analog Devices	ISTP/HYDRA	PPM-93-040
182	DG307A	SPDT Switch	Siliconix	ISTP/WAVES	PPM-93-045
183	HI-201	SPST Switch	Harris	ISTP/WAVES	PPM-93-046
184	HI-509	4-ch. MUX	Harris	ISTP/WAVES	PPM-93-047
185	54AC112	Flip-Flop	National	FAST/MUE	PPM-93-049

Table I: Total Dose Radiation Testing for Goddard Projects (Page 6 of 8)

S/N	Part Number	Part Type	Manufacturer	Project	Report
186	54AC240	Buffer/Driver	National	FAST/MUE	PPM-93-050
187	54AC193	Binary Counter	Harris	FAST/MUE	PPM-93-051
188	CJ28C256	32Kx8EEPROM	SEEQ	BCMS/GCMS	PPM-93-052
189	UC1845J/883	PWM	Unitrode	FAST/MU3	PPM-93-059
190	MQ80386-20	μP	Intel	SMEX/FAST	PPM-93-062
191	OW628128CD	12Kx8 RAM	Hitachi	FAST/MU3	PPM-93-063
192	HM628128LP-10	12Kx8 RAM	Harris	SMEX/FAST	PPM-93-065
193	HX6464	64Kx1 SRAM	Honeywell	GPEP/PPL	PPM-93-064
194	54AC Annealing	54AC parts		GPEP	PPM-93-061
195	OMH3075S	Hall Eff. Sensor	Optek	SWAS/MUE	PPM-93-070
196	8002300	5-tap Delay Line	Hytek	HST/COP	PPM-93-078
197	G311P759-4M19430	Oscillator	Monitor	FAST/MUE	PPM-93-101
198	G311P759/01-18M	Oscillator	Monitor	FAST/MUE	PPM-93-102
199	54HC4051	MUX/DMUX	Harris	ISTP/SOHO	PPM-93-104
200	54HC123	Multivibrator	Harris	GGs/WIND	PPM-93-105
201	LP2951	Regulator	National	ISTP/SOHO	PPM-93-106
202	MP7628	D/A Converter	Micro Power	ISTP/SOHO	PPM-93-108
203	54HC165	Shift Register	Motorola	ISTP/SOHO	PPM-93-107
204	LM108A	Op Amp	National	ISTP/SOHO	PPM-94-001
205	54ACQT08	AND Gate	National	SMEX/FAST	PPM-94-003
206	AD7672	A/D Converter	Analog Devices	ISTP/SOHO	PPM-94-004
207	A1020B	Gate Array	Actel	GPEP/PPL	PPM-94-005
208	LM139	Comparator	National	CASSINI	PPM-94-008
209	LM139	Comparator	PMI	GOES/SXI	PPM-94-010
210	5406	Inverting Buffer	TI	GOES/SXI	PPM-94-011
211	1280A	Gate Array	Actel	GPEP/PPL	PPM-94-012
212	LM139	Comparator	National	CASINI/INMS	PPM-94-013
213	54HC4053	MUX/DEMUX	Harris	ISTP/SOHO	PPM-94-014
214	PA10A	Power Op Amp	Apex Microtech	CASSINI	PPM-94-015
215	OP177A	Op Amp	Analog Devices	FUSE	PPM-94-016
216	AD7545	D/A Converter	Analog Devices	FUSE	PPM-94-017
217	EL2243	Dual Op Amp	Elantec	FUSE	PPM-94-018
218	LF411	Op Amp	National	FUSE	PPM-94-019
219	OP 07A	Op Amp	Linear Tech.	EOS/AM	PPM-94-020
220	LM108A	Op Amp	Linear Tech.	EOS/AM	PPM-94-022
221	26C31	Quad Op Amp	National	FUSE	PPM-94-023
222	ADC0816	8-bit ADC/MUX	National	FUSE	PPM-94-025
223	54AC299	Shift Register	National	EOS/AM	PPM-94-026

Table I: Total Dose Radiation Testing for Goddard Projects (Page 7 of 8)

S/N	Part Number	Part Type	Manufacturer	Project	Report
224	54AC374	D-type Flip-Flop	National	EOS/AM	PPM-94-027
225	LM108	Op Amp	National	CASSINI	PPM-94-028
226	TC4420	MOSFET Buffer	Teledyne	GOES/SXI	PPM-94-035
227	82C54	Interval Timer	Intel	HST/BASE	PPM-94-036
228	OP400AY	Quad Op Amp	Analog Devices	HST/ADD	PPM-94-037
229	LM139	Comparator	National	CASSINI	PPM-94-038
230	DAC08A	D/A Converter	Analog Devices	CASSINI	PPM-95-103
231	F100324	Translator	National	EOS/AM	PPM-94-040
232	7204	FIFO	IDT	HST/BASE	PPM-95-101
233	F100325	Translator	National	EOS/AM	PPM-95-102
234	LM10	Op Amp	Linear Tech.	HST/CAL	PPM-95-105
235	RP7820	A/D Converter	Space Elec., Inc.	CASSINI	PPM-95-107
236	AD565	D/A Converter	Analog Devices	CASSINI	PPM-95-108
237	TL074	Quad Op Amp	TI	HST/CAL	PPM-95-109
238	TSC4429	MOSFET Driver	TI	CASSINI	PPM-95-110
239	HCPL-5631	Optocoupler	HP	HST/STIS	PPM-95-113
240	LM10	Op Amp	National	HST/CAL	PPM-95-115
241	SDM3304	NPN Transistor	Solitron	HST/CAL	PPM-95-118
242	IDT49C460	Error Detector	IDT	HST/BASE	PPM-95-119
243	MD82C59A	Controller	Harris	HST/BASE	PPM-95-123
244	AD677	A/D Converter	Analog Devices	HST/BASE	PPM-95-124
245	MFL2805S	DC/DC Conv.	Interpoint	HST/PCP	PPM-95-126
246	MFL2815S	DC/DC Conv.	Interpoint	HST/PCP	PPM-95-127
247	MFL2812S	DC/DC Conv.	Interpoint	HST/PCP	PPM-95-128
248	OP27A	Op Amp	LTC	CASSINI	PPM-95-129
249	MC1717	Motor Driver	Unitrode	HST/ADD	PPM-95-134
250	MFL2815	DC/DC Conv.	Interpoint	HST/PCP	PPM-95-135
251	SSP21110-25	Power Conv.	ILC	FUSE	PPM-95-136
252	6N134	Optocoupler	ILC	CASSINI	PPM-95-137
253	MIC4420	MOSFET Driver	Micrel	CASSINI	PPM-95-139
254	28C256	EEPROM	SEEQ	AXAF	PPM-95-141
255	MIC4429	MOSFET Driver	Micrel	CASSINI	PPM-95-142
256	LT1021-10	Voltagr Ref.	Linear Tech.	CASSINI	PPM-95-145
257	LT1021-5	Voltagr Ref.	Linear Tech.	CASSINI	PPM-95-144
258	28C256	EEPROM	SEEQ	TOMS	PPM-95-147
259	OP 07A	Op Amp	PMI	CASSINI	PPM-95-149
260	AD645	Op Amp	Analog Devices	NOAA/KLM	PPM-95-150

Table I: Total Dose Radiation Testing for Goddard Projects (Page 8 of 8)

261	DAC8408	D-A Converter	PMI	HST/ADD	PPM-95-151
262	LM136	Voltagr Reg.	LTC	CASSINI	PPM-95-152
263	IBM0116400AJ3	4Mx4 DRAM	IBM	LANDSAT	PPM-95-153
264	TLE2142	Dual Op Amp	TI	HST/STIS	PPM-95-156
265	28C256	EEPROM	SEEQ	TOMS	PPM-95-169
266	LP2951	Prog. V. Reg.	NSI	CASSINI	PPM-95-158
267	LM158	Dual Op Amp	NSI	CASSINI	PPM-95-160
268	PA10	Power Op Amp	Apex Microtech	CASSINI	PPM-95-165
269	SE5521	Signal Cond.	Signetics	CASSINI	PPM-95-162
270	SMP11	S/H Amplifier	PMI	CASSINI	PPM-95-163
271	1020B	Gate Array	Actel	GPEP/PPL	PPM-95-130
272	1280A	Gate Array	Actel	GPEP/PPL	PPM-95-131
273	1020B	Gate Array	Actel	GPEP/PPL	PPM-95-167
274	1280A	Gate Array	Actel	GPEP/PPL	PPM-95-168
275	HCPL5401	Optocoupler	H-P	HST/STIS	PPM-95-166
276	IBM0116400AJ3	4Mx4 DRAM	IBM	LANDSAT	PPM-95-170
277	LP2951	Prog. V. Reg.	NSI	CASSINI	PPM-95-173
278	HA7-5127	Op Amp	Harris	HST	PPM-95-171
279	LM119	Dual Op Amp	LTC	CASSINI	PPM-95-174
280	PA51M	Op Amp	Apex Microtech	FUSE	PPM-95-172
281	28C256	EEPROM	SEEQ	AXAF/Gulton	PPM-95-175
282	AD829	Op Amp	Analog Devices	HST/STIS	PPM-95-178
283	AD620	Op Amp	Analog Devices	HST/NICMOS	PPM-95-178
284	DAC8408	DAC	Analog Devices	HST/ADD	PPM-95-176
285	28C010	EEPROM	SEI/Hitachi	AXAF/Gulton	PPM-95-182
286	SP9380	DAC, 18-bit	Sipex	XDS/ACHE	PPM-95-175
287	DAC08	DAC, 8-bit	PMI/Analog	CASSINI	PPM-95-185
288	NT5C1008	CMSO SRAM	Micron Tech.	AXAF/Gulton	PPM-95-186
289	28C256	EEPROM	SEI	AXAF/Gulton	PPM-95-187

Table II Proton and Heavy Ion Testing for Single Event Effects (Page 1 of 3)

It should be noted that radiation results can vary significantly with changes in the manufacturer's process technology and design changes, as well as with details of the SEE test setup, supply voltage, test temperatures and the functional characteristics measured. The information in these reports is for general guidance only, and is subject to change at any time.

S/N	Report Title	Test Date	Report #
1	Heavy Ion Tests at BNL on DQ28C256 and 82HS641A	11/09/90	SEP-1
2	Proton Tests at HU on HFE4811 and HFD3801	11/30/90	SEP-2
3	Heavy Ion Tests at BNL on HFE4811 and HFD3801	12/15/90	SEP-3
4	Heavy Ion Tests at BNL on HFE4811 and HFD3801	04/24/91	SEP-4
5	Proton Tests at IU on HFE4811 and HFD3801	05/20/91	SEP-5
6	Transient SEUs in a Fiber Optic System for Space Applications	07/16/91	SEP-6
7	A Spacecraft Fiber Optic Data System - radiation Effects	09/09/91	SEP-7
8	Proton Tests at HU on SEDS MIL-STD-1773 Optical Terminal	09/28/91	SEP-8
9	SEEQ EEPROM Heavy Ion Tests at BNL on DQ28C256	10/28/91	SEP-9
10	Single Event Latchup Test Report for Two Matra ASICs	10/28/91	SEP-10
11	Single Event Latchup Test Report for Intel 80386, 80387	10/28/91	SEP-11
12	DRAFT Effects and Analysis of SEP Test Results on Intel's 80386	11/14/91	SEP-12
13	RS Encoder Test Structure Heavy Ion Exper. at BNL on HP-fab Dual RS Encoder	12/18/91	SEP-13
14	RPP ETU Heavy Ion Exper. at BNL on SEDS SC Computer (80386 and others)	12/18/91	SEP-14
15	SEL Testing of AMD TAXI Chipset at BNL (AM7968 TAXI Chipset)	02/09/92	SEP-15
16	RS Encoder/Test Structure Heavy Ion Exper. at BNL on HP-Tab Dual RS Encoder	02/09/92	SEP-16
17	Proton Testing at UCD on SEDS MIL-STD-1773 Optical Terminal, Honeywell Integrated Optoelectronics	05/18/92	SEP-17
18	Heavy Ion Test Report for Hitachi 4Mbit SRAM and Ball EMXO Oscillator	06/24/92	SEP-18
19	Heavy Ion Test Report for NASA VLSI Design Center Test Structure	06/24/92	SEP-19
20	Heavy Ion Test Report for Hitachi 4Mbit SRAM	09/02/92	SEP-20
21	Heavy Ion Test Report for IDT 7202RE FIFO	09/02/92	SEP-21
22	Heavy Ion Test Report for Tests Performed at BNL on 12/3/92 on UPMC 32Kx8 SRAM, RS Encoder, Cypress 22V10 PALs.	12/03/92	SEP-22

Table II Proton and Heavy Ion Testing for Single Event Effects (Page 2 of 3)

S/N	Report Title	Test Date	Report #
23	Heavy Ion Test Report for Tests Performed at BNL on 4/7/93 on Mongoose R3000 Microprocessor	04/07/93	SEP-23
24	Heavy Ion Test Report for Tests Performed at BNL on AD1671 ADC	04/19/93	SEP-24
25	Heavy Ion Test Report for Tests Performed at BNL on 5/3/93 on HS26C31, HS26C32 and HS2420	05/03/93	SEP-25
26	Heavy Ion Test Report for Tests Performed at BNL on 12/3/92, 5/19/93 and 6/18/93 on Hitachi 1 Mb 68128 SRAM, Gazelle Hot Rod and Elantec EL2243	06/18/93	SEP-26
27	Heavy Ion Test Report for Tests Performed on 8/3-4/93 at BNL on 1553B Transceivers and Other Devices	08/04/93	SEP-27
28	Heavy Ion Test Report for Tests Performed on 6/18/93 at BNL on UT63M125, HS508RH and AD676	06/18/93	SEP-28
29	Heavy Ion Test Report for Tests Performed on 2/24-25/94 at BNL on A1280A, HS5212, ILC SSP-21110-025, LM139 and LM108	02/25/94	SEP-29
30	Heavy Ion Test Report for Tests Performed on 6/30-7/1/94 at BNL on 7203L40DB, LM139A, OP07AJ, AD524, LM108AH and LM124	07/01/94	SEP-30
31	Single Event Effect Test Report for GSFC Test Trip to BNL July 29 - Aug 1, 1994 (Part types tested: LM139, REF-02-373J, SE5521F, AHE2815DF/CH-SLV, LM158, PA10, SMP11, LM119, OP97, DAC08AQ, 7820RP/372, LM136AH, AD565, LM117H, LM120H-12/883C, KM44C4000AJ-7, TC5117400J-6, 70V25)	10/06/94	SEP-31
32	Single Event Effect Test Report for GSFC Test Trip to BNL Nov. 8 - Nov. 11, 1994 (Part types tested: HR2340, AHE2815DF/CH-SLV, AHE2815D/HB, 2690R-D15F, MFL2815D, MFL2815S, MFL2812S, MFL2805S, 7204, 7203ERPDE, MIC4427, 49C460DGB, LP2951, HN58C1001, 28C256ERPDB, AD565A)	11/22/94	SEP-32
33	Single Event Effect Test Report for EEPROMs at GSFC Test Trip to BNL Jan. 24-25, 1995 (Part types tested: HN58C1001, SA28C256ERPDB, SA28C256ARP)	01/25/95	SEP-33
34	Test Report for Proton SEU Results of 16 Mbit DRAMs at ACD Cyclotron Facility 3/24-25/95 (Part types tested: TP0116400AJ3B-70, 43G9240, HM5116400AJ7, 4216400-70)	03/25/95	SEP-34
35	Test Report for Proton SEU Results of 16 Mbit DRAMs at UCD Cyclotron Facility 5/5-6/95 (Part types tested: 0116400J1C-70, 0116400OPT1C-70, D4216400G3-70)	05/06/95	SEP-35
36	Preliminary Test Synopsis for IBM Luna-ES Page Mode SEU Experiment (Aug. 18, 1995) (Part types tested: IBM Luna-ES 16 Mbit DRAM (4Mx4) 5V DD3 version)	08/18/95	SEP-36

Table II Proton and Heavy Ion Testing for Single Event Effects (Page 3 of 3)

37	Single Event Effect Test Report for FLASH EEPROMs at GSFC Test Trip to BNL Aug. 16-18, 1995 (Part types tested: E28F016SB)	08/18/95	SEP-37
38	Test Report for Proton SEU Results of ISC Stack DRAMs at IU Cyclotron Facility 9/5-8/95 (Part types tested: 20 Mbyte stack 16 Mbit (4Mx4) DRAM, IBM Luna ES DD3 die)	09/08/95	SEP-38
39	Heavy Ion Single Event Measurements and Predictions on the MDI 2680M-SO5F and the MDI 2690-RD15 (Part types tested: MDI 2680M-SO5F, MDI 2690-RD15)	10/17/95	SEP-39
40	Single Event Effect Test Report on the Intel 80386 Microprocessor, 80387 Coprocessor, and 82380 Integrated Peripheral tested 2/20-21/96 (Part types tested: 80386, 80387, 82380)	02/21/96	SEP-40

THIS PAGE INTENTIONALLY LEFT BLANK

APPENDIX E

GSFC Procurement Specifications

This appendix contains a list of part procurement specifications maintained by Goddard Space Flight Center. The user is advised to consult Appendix E whenever a preferred part is not available. The recommended order of precedence for selecting nonpreferred parts for use in Goddard projects is as follows:

1. Appendix E to PPL 21
2. MIL specifications
3. Source Control Drawings

The user is cautioned to consult GSFC-311-QPLD-004 (GSFC Qualified Parts List Directory) to verify the current qualification status for parts procured to the specifications listed in this appendix. Reference the PPL preface section for parts information and assistance.

GSFC Procurement Specifications (Page 1 of 3)

GSFC Drawing No.	Description	Rev	Rev Date
Capacitors			
S-311-P-15	Capacitor, Ceramic Monolayer, High Voltage, for Space Flight Use	F	05/11/92
S-311-P-15/1	Capacitor, Ceramic Monolayer, High Voltage, for Space Flight Use	D	02/21/92
S-311-P-17	Capacitor, Fixed Electrolytic, Tantalum Solid Electrolyte	B	04/19/91
S-311-P-17/1	Capacitor, Fixed Electrolytic, Tantalum Solid Electrolyte	B	04/19/91
S-311-P-17/2	Capacitor, Fixed Electrolytic, Tantalum Solid Electrolyte	B	04/19/91
S-311-P-17/3	Capacitor, Fixed Electrolytic, Tantalum Solid Electrolyte	B	04/19/91
Connectors			
S-311-P-626	Connector, Electrical, Rack And Panel Pin EMI Solder Type	—	12/03/90
S-311-P-768	Connector, Electrical, Miniature, Circular, Low Outgassing [Amphenol (453)Suffix], General Specification for	—	02/25/94
Crystals			
S-311-P-8 (17)	Crystal Unit, Quartz, For Space Flight Use	—	04/06/73
S-311-P-8/1 (17)	Crystal Unit, (0.100 To 0.299 MHZ Range)	—	04/06/73
S-311-P-8/2 (17)	Crystal Unit, (0.300 To 0.0799 MHZ Range)	—	04/06/73
S-311-P-8/3 (17)	Crystal Unit, (0.800 To 2.99 MHZ Range)	—	04/06/73
S-311-P-8/4 (17)	Crystal Unit, (3.0 To 19.9 MHZ Range)	—	04/06/73
S-311-P-8/5 (17)	Crystal Unit, (20.0 To 89.9 MHZ Range)	—	04/06/73
S-311-P-8/6 (17)	Crystal Unit, (90.0 To 200.0 MHZ Range)	—	04/06/73
Diodes			
S-311-531	Semiconductor, Device, Diode, Silicon, Type GSD421	—	10/22/86
S-311-532	Semiconductor, Device, Diode, Silicon, Type GSD41	—	10/31/86
S-311-P-670	Diode, High Voltage, Fast Recovery HRF30	—	02/07/91
S-311-P-713	Diode, Zener, Low Current Type LVA450RHA Level "R"	—	09/26/91
S-311-P-714	Diode, Zener, Low Current Type LVA462RHA Level "R"	—	09/26/91
S-311-P-715	Diode, High Performance, Zener Type LVA3100RHA Level "R"	—	09/26/91
S-311-P-763	850 Manometer Fiber Optic Receiver Devices with PIN Photodiode Input and TTL Output	—	07/21/92
S-311-P-786	Dual Beam, Single Quantum Well, GaAlAs, Laser Diode. (SDL5601-V1)	A	11/08/94
S-311-P-787	Diode, Temperature Sensing, XDT-5070	—	09/07/94
S-311-P-790	Diode, Light Emitting, Infrared, LPE GaAlAs (OD-880WJ)	—	01/05/95
S-311-P-791	Diode, Light Emitting, Infrared, GaAlAs	—	01/23/95
Filters			
S-311-P-5	Filter, EMI, General Specification	B	07/22/91
S-311-P-5/1	Filter, EMI Suppression, Detailed Specification	B	07/22/91
S-311-P-5/2	Filter, EMI Suppression, Detailed Specification	B	07/22/91
S-311-P-5/3	Filter, EMI Suppression, Detailed Specification	B	07/22/91
S-311-P-5/4	Filter, EMI Suppression, Detailed Specification	C	07/22/91
S-311-P-5/5	Filter, EMI Suppression, Detailed Specification	A	07/22/91

GSFC Procurement Specifications (Page 2 of 3)

GSFC Drawing No.	Description	Rev	Rev Date
Heaters			
S-311-P-079	Heaters-Thermofoil, General Specification	E	02/23/96
S-311-P-079/01	Heaters-Thermofoil, Detailed Specification for	C	08/06/91
S-311-P-079/02	Heaters-Thermofoil, Detailed Specification for	C	08/06/91
S-311-P-079/03	Heaters-Thermofoil, Detailed Specification for	B	08/06/91
S-311-P-079/04	Heaters-Thermofoil, Detailed Specification for	B	08/06/91
S-311-P-079/05	Heaters-Thermofoil, Detailed Specification for	C	08/06/91
S-311-P-079/06	Heaters-Thermofoil, Detailed Specification for	B	08/06/91
S-311-P-079/07	Heaters-Thermofoil, Detailed Specification for	A	08/06/91
S-311-P-079/08	Shunt Dissipator, Single Plane, Detail Specification for	B	05/06/94
S-311-P-079/09	Shunt Dissipator, Dual Plane, Detail Specification for	—	10/20/92
S-311-P-079/10	Shunt Heater, Single Plane, Detail Specification for	—	04/08/93
S-311-P-079/11	Thermofoil, Heater, Detailed Specification for	B	09/14/95
Microcircuits			
S-311-P-671	Microcircuit, Digital CMOS/SOS CD400B Logic RHA Level 'R'	—	03/05/91
S-311-P-673	Microcircuit, High Speed CMOS/SOS, HCS/HCTS Type	—	01/23/91
S-311-P-690	Microcircuit, High Speed CMOS/SOS, 54HCS/HCTS Type	—	02/27/91
S-311-P-691	Microcircuit, Ultra-Low Power Op-Amp HA7-5141 Radiation Level 'D'	—	02/22/91
S-311-P-692	Microcircuit, Dual Ultra-Low Power Op-Amp HA7-5142 RAD Level 'D'	—	02/22/91
S-311-P-693	Microcircuit, Single Low Power Op-Amp HA7-5151 Radiation Level 'D'	—	02/22/91
S-311-P-694	Microcircuit, Dual Low Power Op-Amp HA7-5152 Radiation Level 'D'	—	02/22/91
S-311-P-695	Microcircuit, Precision JFET Op-Amp HA7-5170 Radiation Level 'D'	—	02/22/91
S-311-P-697	Microcircuit, Analog MUX High Impedance Input, Type 1840RH	—	08/29/91
S-311-P-698	Hybrid, Discriminator, Amp Type A-XXX5141 Radiation Level 'D'	—	03/04/91
S-311-P-702	Microcircuit, Voltage Reference, Bipolar, +10V Type Ref.-01	—	08/29/91
S-311-P-703	Microcircuit, Voltage Reference, Bipolar, +5V Type Ref.-02	—	08/29/91
S-311-P-704	Microcircuit, A/D Converter CMOS, 16 Bit CS5016 RHA Level 'D'	—	07/09/91
S-311-P-705	Microcircuit, FIFO Memory, CMOS-SOS, 512 X 9 Bit Type 7001RHA	—	09/26/91
S-311-P-706	Microcircuit, SRAM, CMOS, 8K X 8 Bit RHA Level "R" Type 6808RH	—	09/19/91
S-311-P-708	Microcircuit, Interrupt Controller 82C59A RAD RAH "R"	—	09/09/91
S-311-P-712	Microcircuit, Op-Amp, Bipolar, Low Power, Type 3530RHA Level 'R'	—	09/13/91
S-311-P-721	Microcircuit, Microcontroller, Real Time Express RN, RTX 2010RH	—	01/05/93
S-311-P-760	Microcircuit, MIL-C-1553 Bus Controller UT1553BBCRT and UT1553BBCTM	A	08/07/92
S-311-P-765	Microcircuit, Memory, CMOS 32K X 8 Bit, EEPROM RH	—	11/04/92
S-311-P-766	Microcircuit, Linear, +5 and +/- 15 Volts, Triple Output, 30 Watts, Radiation Hardened, DC to DC Converter, Hybrid	—	10/25/93
S-311-P-788	Microcircuit, Hybrid, Photodetector with Integral Amplifier	A	03/02/95
S-311-P-789	Microcircuit, Hybrid, 5 Channel Pre-Amplifier, FP3	D	11/09/95

GSFC Procurement Specifications (Page 3 of 3)

GSFC Drawing No.	Description	Rev	Rev Date
Resistors			
S-311-P-741	Resistor, Fixed, Low TC, Precision, High Voltage	—	05/10/91
S-311-P-794	Resistor, Fixed, Low TC, Precision, High Stability	A	11/02/95
S-311-P-795	Resistor, Fixed, Foil, Precision, Power, Current Sensing, Hermetic	A	10/10/95
S-311-P-796	Resistor, "Matched-Pair", Low TC, Precision, Radial-Lead	A	1/19/96
S-311-P-798	Potentiometer, Precision Trimming, Vishay 128G	—	08/15/95
Thermistors			
S-311-424	Thermistor, Thermally Sensitive, Negative TC, Super Stable, Encapsulated	B	03/21/88
S-311-P-767	Thermistor, Hermetically Sealed, Cryogenic, Negative Temperature, Coefficient, Specification for	A	10/12/93
Transistors			
S-311-112	Transistor, Photo Detector, NPN	—	01/25/83
S-311-315	Transistor, JFET, Low Noise (GMP843)	—	02/06/84
S-311-P-781	Dual N-Channel JFET, Matched Pair. (NJ3600)	B	03/02/95
Switches			
S-311-641	Switches, Thermostatic, General Specification	—	09/20/90
S-311-641/01	Switches, Thermostatic (Bimetallic), Subminiature, Sealed	A	03/23/94
Wire/Cable			
S-311-P-71	Wire/Cable, Special Purpose, Twin Conductor Shielded and Jacketed	A	10/29/90